

## FIXBOLT TORNILLO 8.8 - CE OPCIÓN 12

SLEEVE ANCHOR WITH HEX. HEAD SCREW 8.8 GRADE - CE OP.12  
CHEVILLE À DOUILLE AVEC VIS TÊTE HEXAGONALE CLASSE 8.8 - CE OP.12  
HÜLSENANKER MIT SECHSKANTSCHRAUBE KLASSE 8.8 - CE OP.12



CÓDIGO CODE CODE	MEDIDA SIZE MEASURE	BROCA DRILL FORET	PA. (Nm.)	*WLL.		PROF. TALADRO HOLE DEPTH PROF. TROU	EMBALAJE QUANTITY EMBALLAGE		PRECIO TARIFA PRICE LIST PRIX TARIFS PREIS TARIF €/100 u.
				EXTRACCIÓN TENSION LOAD EXTRACTION (kN)	CIZALLADO SHEAR LOAD DISAILLEMENT (kN)		QUANTITY EMBALLAGE	QUANTITY EMBALLAGE	
FT08C	6x45	8	15	2,77	3,50	50	100	1.200	19,78
<sup>1</sup> FT09C	6x45	9	15	<sup>1</sup> 2,77	<sup>1</sup> 3,50	50	100	1.200	22,11
FT08L	6x60	8	15	2,77	3,50	65	100	1.200	21,96
<sup>1</sup> FT09L	6x60	9	15	<sup>1</sup> 2,77	<sup>1</sup> 3,50	65	100	1.200	27,00
FT10C	8x60	10	25	5,00	6,96	65	100	600	34,17
<sup>1</sup> FT11C	8x60	11	25	<sup>1</sup> 5,00	<sup>1</sup> 6,96	65	100	600	37,57
FT10L	8x80	10	25	5,00	6,96	85	100	600	40,00
<sup>1</sup> FT11L	8x80	11	25	<sup>1</sup> 5,00	<sup>1</sup> 6,96	85	100	600	44,00
FT12C	10x70	12	35	6,00	8,50	75	100	600	53,97
<sup>1</sup> FT14C	10x70	14	35	<sup>1</sup> 6,00	<sup>1</sup> 8,50	75	50	300	63,67
FT12L	10x100	12	35	6,00	8,50	105	50	300	68,30
<sup>1</sup> FT14L	10x100	14	35	<sup>1</sup> 6,00	<sup>1</sup> 8,50	105	50	300	79,57
FT16C	12x80	16	50	8,00	11,88	85	50	300	104,30
FT16L	12x110	16	50	8,00	11,88	115	25	150	126,33
FT20C	16x110	20	80	11,11	16,40	115	25	150	218,90
FT20L	16x140	20	80	11,11	16,40	145	25	150	330,67

<sup>1</sup> VALORES PENDIENTES / <sup>1</sup> PENDING VALUES / <sup>1</sup> VALEURS DE PENTE

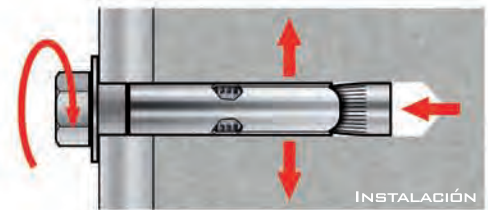
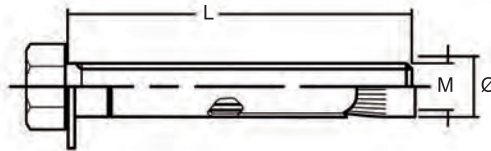

## FIXBOLT ARO

SLEEVE ANCHOR EYE  
CHEVILLE À DOUILLE AVEC PITON  
HÜLSENANKER MIT AUGENSCHRAUBE



CÓDIGO CODE CODE	MEDIDA SIZE MEASURE	BROCA DRILL FORET	ØINT. ØINT.	PA. (Nm.)	*WLL. (kN)	PROF. TALADRO HOLE DEPTH PROF. TROU	EMBALAJE QUANTITY EMBALLAGE		PRECIO TARIFA PRICE LIST PRIX TARIFS PREIS TARIF €/100 u.
							QUANTITY EMBALLAGE	QUANTITY EMBALLAGE	
FA08C	6x45	8	10	10	0,70	60	100	600	32,40
FA09C	6x45	9	10	10	0,70	60	100	600	34,90
FA10C	8x60	10	13	25	1,45	70	50	300	56,63
FA11C	8x60	11	13	25	1,45	70	50	300	62,00
FA12C	10x70	12	14	35	2,50	80	25	150	91,97
FA14C	10x70	14	14	35	2,50	80	25	150	103,30
FA16C	12x80	16	22	50	3,10	90	20	120	163,30

## FIXBOLT GANCHO

SLEEVE ANCHOR HOOK  
CHEVILLE À DOUILLE AVEC CROCHET  
HÜLSENANKER MIT HAKEN



CÓDIGO CODE CODE	MEDIDA SIZE MEASURE	BROCA DRILL FORET	ØINT. ØINT.	PA. (Nm.)	*WLL. (kN)	PROF. TALADRO HOLE DEPTH PROF. TROU	EMBALAJE QUANTITY EMBALLAGE		PRECIO TARIFA PRICE LIST PRIX TARIFS PREIS TARIF €/100 u.
							QUANTITY EMBALLAGE	QUANTITY EMBALLAGE	
FG08C	6x45	8	10	10	0,70	60	100	600	32,40
FG09C	6x45	9	10	10	0,70	60	100	600	34,90
FG10C	8x60	10	14	25	1,45	70	50	300	56,63
FG11C	8x60	11	14	25	1,45	70	50	300	62,00
FG12C	10x70	12	15	35	2,50	80	25	150	91,97
FG14C	10x70	14	15	35	2,50	80	25	150	103,30
FG16C	12x80	16	21	50	3,10	90	20	120	163,30

\* COEFICIENTE DE SEGURIDAD ETAG INCLUIDO / ETAG SAFETY FACTOR INCLUDED / \* COEFFICIENT DE SÉCURITÉ ETAG INCLUS / \* SICHERHEITSAKTOR ENTHALTEN ETAG  
WLL.: CARGA MÁXIMA ADMISIBLE, PA.: PAR DE APRIETE. / WLL.: MAXIMUM ALLOWABLE LOAD. PA.: TORQUE / WLL.: CHARGE MAXIMALE ADMISIBLE. PA.: COUPLE DE SERRAGE

**FIXBOLT ARO ESTAMPADO**

FORGED SLEEVE ANCHOR EYE - PRESSED EYE  
CHEVILLE À DOUILLE AVEC PITON FORGÉ  
HÜLSENANKER MIT GESCHMIEDETE AUGENSCHRAUBE



CÓDIGO CODE CODE	MEDIDA SIZE MEASURE	BROCA DRILL FORET	ØINT. ØINT. ØINT.	PA.	*WLL.	PROF. TALADRO HOLE DEPTH PROF. TROU	EMBALAJE QUANTITY EMBALLAGE		PRECIO TARIFA PRICE LIST PRIX TARIFS PREIS TARIF €/100 u.
	m.m.	m.m.	m.m.	(Nm.)	(kN)	m.m.			
FAE08C	6x45	8	10,0	10	2,77	60	100	600	59,70
FAE10C	8x60	10	11,8	25	5,00	70	50	300	79,22
FAE12C	10x70	12	14,5	35	6,00	80	25	150	134,41
FAE16C	12x80	16	17,0	50	8,00	90	20	120	234,89

**FIXBOLT GANCHO ESTAMPADO**

FORGED SLEEVE ANCHOR HOOK - PRESSED HOOK  
CHEVILLE À DOUILLE AVEC CROCHET FORGÉ  
HÜLSENANKER MIT GESCHMIEDETE HAKEN



CÓDIGO CODE CODE	MEDIDA SIZE MEASURE	BROCA DRILL FORET	ØINT. ØINT. ØINT.	PA.	*WLL.	PROF. TALADRO HOLE DEPTH PROF. TROU	EMBALAJE QUANTITY EMBALLAGE		PRECIO TARIFA PRICE LIST PRIX TARIFS PREIS TARIF €/100 u.
	m.m.	m.m.	m.m.	(Nm.)	(kN)	m.m.			
FGE08C	6x45	8	10	10	0,90	60	100	600	59,70
FGE10C	8x60	10	14	25	1,60	70	50	300	79,22
FGE12C	10x70	12	15	35	2,90	80	25	150	134,41
FGE16C	12x80	16	21	50	4,00	90	20	120	234,89

**FIXBOLT TORNILLO DIN 7991**

SLEEVE ANCHOR WITH SCREW DIN 7991  
CHEVILLE À DOUILLE AVEC VIS DIN 7991  
HÜLSENANKER MIT SCHRAUBE DIN 7991



CÓDIGO CODE CODE	MEDIDA SIZE MEASURE	BROCA DRILL FORET	PA.	*WLL.		PROF. TALADRO HOLE DEPTH PROF. TROU	EMBALAJE QUANTITY EMBALLAGE		PRECIO TARIFA PRICE LIST PRIX TARIFS PREIS TARIF €/100 u.
				EXTRACCIÓN TENSION LOAD EXTRACTION (kN)	CIZALLADO SHEAR LOAD CISAILLEMENT (kN)				
FT108C	6x45	8	10	2,77	3,50	50	100	600	36,53
FT108L	6x60	8	10	2,77	3,50	65	100	600	52,27
FT110C	8x60	10	25	5,00	6,90	65	100	600	61,80
FT111C	8x60	11	25	5,00	6,90	65	100	600	66,85
FT110L	8x80	10	25	5,00	6,90	85	100	600	79,27
FT111L	8x80	11	25	5,00	6,90	85	100	600	85,25
FT112C	10x70	12	35	6,00	8,50	75	50	300	93,42
FT112L	10x100	12	35	6,00	8,50	105	50	300	200,00

**FIXBOLT TORNILLO 8.8 INVIOLEABLE TORX**

SLEEVE ANCHOR WITH MUSHROOM TORX HEAD SCREW 8.8 GRADE (ANTI-THEFT)  
CHEVILLE À DOUILLE AVEC VIS TÊTE RONDE TORX 8.8 (CACHE-TÊTE INAMOVIBLE)  
HÜLSENANKER MIT RUNDKOPFSCHRAUBE TORX 8.8 (INNENSECHSRUND)



CÓDIGO CODE CODE	MEDIDA SIZE MEASURE	BROCA DRILL FORET	LLAVE KEY CLÉ	PA.	*WLL.		PROF. TALADRO HOLE DEPTH PROF. TROU	EMBALAJE QUANTITY EMBALLAGE		PRECIO TARIFA PRICE LIST PRIX TARIFS PREIS TARIF €/100 u.
					EXTRACCIÓN TENSION LOAD EXTRACTION (kN)	CIZALLADO SHEAR LOAD CISAILLEMENT (kN)				
FTIT10C	8x60	10	T-40	25	5,00	6,90	65	100	600	62,10
FTIT11C	8x60	11	T-40	25	5,00	6,90	65	100	600	66,67
FTIT10L	8x80	10	T-40	25	5,00	6,90	85	100	600	64,87
FTIT11L	8x80	11	T-40	25	5,00	6,90	85	100	600	79,57

\* COEFICIENTE DE SEGURIDAD ETAG INCLUIDO / ETAG SAFETY FACTOR INCLUDED / \* COEFFICIENT DE SÉCURITÉ ETAG INCLUS / \* SICHERHEITSAKTOR ENTHALTEN ETAG  
WLL.: CARGA MÁXIMA ADMISIBLE, PA.: PAR DE APRIETE. / WLL.: MAXIMUM ALLOWABLE LOAD. PA.: TORQUE / WLL.: CHARGE MAXIMALE ADMISIBLE. PA.: COUPLE DE SERRAGE

## FIXBOLT TORNILLO 8.8 INVIOLEABLE

SLEEVE ANCHOR WITH MUSHROOM HEAD SCREW 8.8 GRADE (ANTI-THEFT)  
CHEVILLE À DOUILLE AVEC VIS TÊTE RONDE CLASSE 8.8 (CACHE-TÊTE INAMOVIBLE)  
HÜLSENANKER MIT RUNDKOPFSCHRAUBE KLASSE 8.8 (INNENSECHSRUND)

HASTA AGOTAR EXISTENCIAS



CÓDIGO Code Code	MEDIDA Size Measure	BROCA Drill Foret	PA.	*WLL.		PROF. TALADRO Hole Depth Prof. Trou	EMBALAJE Quantity Emballage	PRECIO TARIFA Price List Prix Tarifs Preis Tarif €/100 u.	
				EXTRACCIÓN TENSION EXTRACTION	CIZALLADO LOADSHEAR LOAD DISAILLEMENT				
FT110C	8x60	10	25	5,00	6,90	65	100	600	50,42
FT111C	8x60	11	25	5,00	6,90	65	100	600	53,06

## FIXBOLT TORNILLO INOXIDABLE A-2

SLEEVE ANCHOR WITH HEX. HEAD SCREW - STAINLESS STEEL AISI 304  
CHEVILLE À DOUILLE AVEC VIS TÊTE HEXAGONALE - ACIER INOX. A-2  
HÜLSENANKER MIT SECHSKANTSCHRAUBE - EDELSTAHL A-2



CÓDIGO Code Code	MEDIDA Size Measure	BROCA Drill Foret	PA.	*WLL.		PROF. TALADRO Hole Depth Prof. Trou	EMBALAJE Quantity Emballage	PRECIO TARIFA Price List Prix Tarifs Preis Tarif €/100 u.	
				EXTRACCIÓN TENSION EXTRACTION	CIZALLADO LOADSHEAR LOAD DISAILLEMENT				
FT208C	6x45	8	10	2,77	3,50	50	100	1.200	77,63
FT209C	6x45	9	10	2,77	3,50	50	100	1.200	95,57
FT208L	6x60	8	10	2,77	3,50	65	100	1.200	90,00
FT209L	6x60	9	10	2,77	3,50	65	100	1.200	112,67
FT210C	8x60	10	25	5,00	6,96	65	100	600	133,33
FT211C	8x60	11	25	5,00	6,96	65	100	600	147,67
FT210L	8x80	10	25	5,00	6,96	85	100	600	160,37
FT211L	8x80	11	25	5,00	6,96	85	100	600	175,67
FT212C	10x70	12	35	6,00	8,50	75	50	300	226,67
FT214C	10x70	14	35	6,00	8,50	75	50	300	289,67
FT212L	10x100	12	35	6,00	8,50	105	50	300	280,00
FT214L	10x100	14	35	6,00	8,50	105	50	300	340,00
FT216C	12x80	16	50	8,00	11,88	85	25	150	406,67
FT216L	12x110	16	50	8,00	11,88	115	25	150	570,00
FT220C	16x110	20	80	11,11	16,40	115	10	120	946,67
FT220L	16x140	20	80	11,11	16,40	145	10	60	1.115,48

## FIXBOLT ARO INOXIDABLE A-2

SLEEVE ANCHOR EYE - STAINLESS STEEL AISI 304  
CHEVILLE À DOUILLE AVEC PITON - ACIER INOX. A-2  
HÜLSENANKER MIT AUGENSCHRAUBE - EDELSTAHL A-2



CÓDIGO Code Code	MEDIDA Size Measure	BROCA Drill Foret	ØINT. ØINT. ØINT.	PA.	*WLL.	PROF. TALADRO Hole Depth Prof. Trou	EMBALAJE Quantity Emballage	PRECIO TARIFA Price List Prix Tarifs Preis Tarif €/100 u.	
									(Nm.)
FA208C	6x45	8	10,0	10	2,77	60	100	600	270,00
FA209C	6x45	9	10,0	10	2,77	60	100	600	346,67
FA210C	8x60	10	11,8	25	5,00	70	50	300	346,67
FA211C	8x60	11	11,8	25	5,00	70	50	300	502,75
FA212C	10x70	12	14,5	35	6,00	80	25	150	586,67
FA214C	10x70	14	14,5	35	6,00	80	25	150	775,46
FA216C	12x80	16	17,0	50	8,00	90	20	120	1.401,13

\* COEFICIENTE DE SEGURIDAD ETAG INCLUIDO / ETAG SAFETY FACTOR INCLUDED / \* COEFFICIENT DE SÉCURITÉ ETAG INCLUS / \* SICHERHEITSAKTOR ENTHALTEN ETAG

WLL.: CARGA MÁXIMA ADMISIBLE, PA.: PAR DE APRIETE. / WLL.: MAXIMUM ALLOWABLE LOAD. PA.: TORQUE / WLL.: CHARGE MAXIMALE ADMISIBLE. PA.: COUPLE DE SERRAGE

**FIXBOLT GANCHO INOXIDABLE A-2**

SLEEVE ANCHOR HOOK - STAINLESS STEEL AISI 304  
CHEVILLE À DOUILLE AVEC CROCHET - ACIER INOX. A-2  
HÜLSENANKER HAKEN - EDELSTAHL A-2



CÓDIGO CODE CODE	MEDIDA SIZE MEASURE	BROCA DRILL FORET	ØINT. ØINT. ØINT.	PA.	*WLL.	PROF. TALADRO HOLE DEPTH PROF. TROU	EMBALAJE QUANTITY EMBALLAGE	PRECIO TARIFA PRICE LIST PRIX TARIFS PREIS TARIF €/100 U.	
	m.m.	m.m.	m.m.	(Nm.)	(kN)	m.m.			
FG208C	6x45	8	10	10	0,90	60	100	600	270,00
FG209C	6x45	9	10	10	0,90	60	100	600	346,67
FG210C	8x60	10	14	25	1,60	70	50	300	346,67
FG211C	8x60	11	14	25	1,60	70	50	300	502,75
FG212C	10x70	12	15	35	2,90	80	25	150	586,67
FG214C	10x70	14	15	35	2,90	80	25	150	775,46
FG216C	12x80	16	21	50	4,00	90	20	120	1.401,13

**FIXBOLT TORNILLO DIN 7991 INOXIDABLE A-2**

SLEEVE ANCHOR WITH SCREW DIN 7991 - STAINLESS STEEL AISI 304  
CHEVILLE À DOUILLE AVEC VIS DIN 7991 - ACIER INOX. A-2  
HÜLSENANKER MIT SCHRAUBE DIN 7991 - EDELSTAHL A-2



CÓDIGO CODE CODE	MEDIDA SIZE MEASURE	BROCA DRILL FORET	PA.	*WLL.	PROF. TALADRO HOLE DEPTH PROF. TROU	EMBALAJE QUANTITY EMBALLAGE	PRECIO TARIFA PRICE LIST PRIX TARIFS PREIS TARIF €/100 U.		
	m.m.	m.m.	(Nm.)	EXTRACCIÓN TENSION LOAD EXTRACTION (kN)	CIZALLADO SHEAR LOAD CISAILLEMENT (kN)	m.m.			
FT1208C	6x45	8	10	2,77	3,50	50	100	600	84,33
FT1208L	6x60	8	10	2,77	3,50	65	100	600	105,77
FT1210C	8x60	10	25	5,00	6,96	65	100	600	148,33
FT1210L	8x80	10	25	5,00	6,96	85	100	600	188,33
FT1212C	10x70	12	35	6,00	8,50	75	50	300	251,62
FT1212L	10x100	12	35	8,00	8,50	105	50	300	297,07

**FIXBOLT TORNILLO INOXIDABLE A-4<sup>1</sup>**

SLEEVE ANCHOR WITH HEX. HEAD SCREW - STAINLESS STEEL AISI 316  
CHEVILLE À DOUILLE AVEC VIS TÊTE HEXAGONALE - ACIER INOX. A-4  
HÜLSENANKER MIT SECHSKANTSCHRAUBE - EDELSTAHL A-4



CÓDIGO CODE CODE	MEDIDA SIZE MEASURE	BROCA DRILL FORET	PA.	*WLL.	PROF. TALADRO HOLE DEPTH PROF. TROU	EMBALAJE QUANTITY EMBALLAGE	PRECIO TARIFA PRICE LIST PRIX TARIFS PREIS TARIF €/100 U.		
	m.m.	m.m.	(Nm.)	EXTRACCIÓN TENSION LOAD EXTRACTION (kN)	CIZALLADO SHEAR LOAD CISAILLEMENT (kN)	m.m.			
FT408C	6x45	8	10	2,77	3,50	50	100	1.200	127,77
FT409C	6x45	9	10	2,77	3,50	50	100	1.200	148,86
FT408L	6x60	8	10	2,77	3,50	65	100	1.200	143,33
FT409L	6x60	9	10	2,77	3,50	65	100	1.200	179,39
FT410C	8x60	10	25	5,00	6,96	65	100	600	256,67
FT411C	8x60	11	25	5,00	6,96	65	100	600	283,33
FT410L	8x80	10	25	5,00	6,96	85	100	600	290,17
FT411L	8x80	11	25	5,00	6,96	85	100	600	326,51
FT412C	10x70	12	35	6,00	8,50	75	50	300	426,67
FT414C	10x70	14	35	6,00	8,50	75	50	300	443,73
FT412L	10x100	12	35	6,00	8,50	105	50	300	556,67
FT414L	10x100	14	35	6,00	8,50	105	50	300	575,58
FT416C	12x80	16	50	8,00	11,88	85	25	150	773,33
FT416L	12x110	16	50	8,00	11,88	115	25	150	954,42
FT420C	16x110	20	80	11,11	16,40	115	10	120	1.436,80
FT420L	16x140	20	80	11,11	16,40	145	10	60	2.159,67

<sup>1</sup> CAMISA Y TUERCA EN INOX. AISI 304 / <sup>1</sup> BODY AND NUT MADE OF STAINLESS STEEL / <sup>1</sup> CORPS ET ÉCROU EN ACIER INOXIDABLE

\* COEFICIENTE DE SEGURIDAD ETAG INCLUIDO / ETAG SAFETY FACTOR INCLUDED / \* COEFFICIENT DE SÉCURITÉ ETAG INCLUS / \* SICHERHEITSAKTOR ENTHALTEN ETAG  
WLL.: CARGA MÁXIMA ADMISIBLE, PA.: PAR DE APRIETE. / WLL.: MAXIMUM ALLOWABLE LOAD. PA.: TORQUE / WLL.: CHARGE MAXIMALE ADMISIBLE. PA.: COUPLE DE SERRAGE



## ANCLAJE ANILLA SN ZN/BC

WEDGE ANCHOR - ZINC PLATED / YELLOW ZINC PLATED  
 GOUJON D'ANCRAGE AVEC TÔLE MICE ZINGUÉ / ZINGUÉ JAUNE  
 ANKER MIT FEINBLECH VERZINKT / GELB VERZINKT

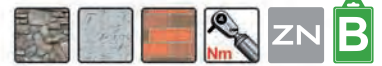

CÓDIGO CODE CODE	MEDIDA SIZE MESURE m.m.	BROCA DRILL FORET m.m.	PA. (Nm.)	*WLL.		EMBALAJE QUANTITY EMBALLAGE		PRECIO TARIFA PRICE LIST PRIX TARIF PREIS TARIF €/100 u.
				EXTRACCIÓN TENSION LOAD EXTRACTION (kN)	CIZALLADO SHEAR LOAD CISAILLEMENT (kN)			
SNZ06045	6x45	6	10	0,61	0,59	100	1.200	19,97
SNZ06060	6x60	6	10	0,80	0,59	100	1.200	22,90
SNZ06100	6x100	6	10	0,80	0,59	100	600	28,07
SNZ06120	6x120	6	10	0,80	0,59	100	600	30,87
SNZ06140	6x140	6	10	0,80	0,59	100	600	35,20
SNZ08050	8x50	8	20	0,92	0,54	100	1.200	26,90
SNZ08075	8x75	8	20	1,16	1,08	100	600	29,87
SNZ08115	8x115	8	20	1,16	1,08	100	600	41,80
SNZ10070	10x70	10	40	1,03	1,23	50	600	42,83
SNZ10090	10x90	10	40	1,29	1,71	50	300	47,77
SNZ10120	10x120	10	40	1,29	1,71	50	300	56,73
SNZ12075	12x75	12	50	1,80	1,38	25	300	61,70
SNZ12090	12x90	12	50	2,02	2,16	25	300	65,70
SNZ12110	12x110	12	50	2,02	2,40	25	300	73,63
SNZ12140	12x140	12	50	2,02	2,40	25	150	99,53
SNZ12160	12x160	12	50	2,02	2,40	20	120	117,43
SNZ12180	12x180	12	50	2,02	2,40	20	120	129,37
SNZ14080	14x80	14	85	2,40	2,20	25	150	136,67
SNZ14095	14x95	14	85	2,40	2,20	25	150	142,87
SNZ14110	14x110	14	85	2,40	2,20	25	150	152,40
SNZ14130	14x130	14	85	2,40	2,20	25	150	176,20
SNZ14145	14x145	14	85	2,40	2,20	25	150	210,00
SNZ14180	14x180	14	85	2,40	2,20	25	150	233,87
SNZ16090	16x90	16	125	1,39	1,67	25	150	125,37
SNZ16125	16x125	16	125	2,83	4,47	25	150	139,33
SNZ16145	16x145	16	125	2,83	4,47	25	150	169,17
SNZ16180	16x180	16	125	2,83	4,47	10	60	238,80
SNZ16220	16x220	16	125	2,83	4,47	10	40	288,30
SNZ20160	20x160	20	250	3,60	6,20	10	60	312,43
SNZ20220	20x220	20	250	4,04	6,55	10	40	473,13
SNZ20270	20x270	20	250	4,04	6,55	10	40	537,30

\*\* ESTE PRODUCTO SE PODRÁ SERVIR EN ACABADO ZINCADO O BICROMATADO SEGÚN DISPONIBILIDAD.

\*\* THIS PRODUCT CAN BE SERVE ZINC PLATED OR YELLOW ZINC PLATED SUBJECT TO AVAILABILITY.

\*\* CE PRODUIT IL PEUT SERVIR EN ZINGUÉ DU ZINGUÉ JAUNE SELON LES DISPONIBILITÉS.

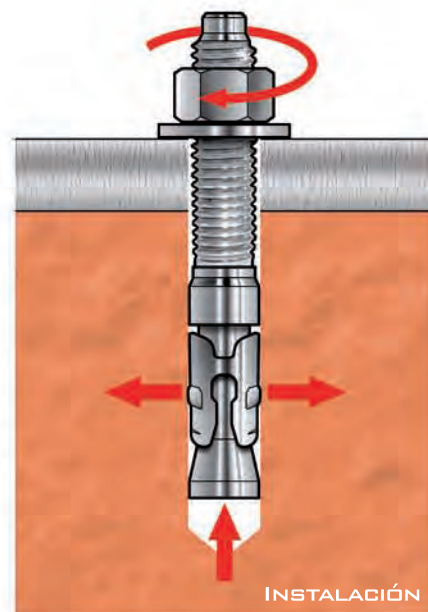
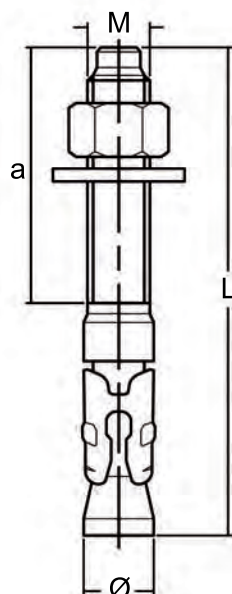

\* COEFICIENTE DE SEGURIDAD ETAG INCLUIDO / ETAG SAFETY FACTOR INCLUDED / \* COEFFICIENT DE SÉCURITÉ ETAG INCLUS / \* SICHERHEITSAKTOR ENTHALTEN ETAG

WLL.: CARGA MÁXIMA ADMISIBLE, PA.: PAR DE APRIETE. / WLL.: MAXIMUM ALLOWABLE LOAD. PA.: TORQUE / WLL.: CHARGE MAXIMALE ADMISIBLE. PA.: COUPLE DE SERRAGE

**ANCLAJE ANILLA SN HOMOLOGADO - CE OPCIÓN 1**

NUEVO / NEW / NEUF / NEU

WEDGE ANCHOR - CE OPT.1

GOUJON D'ANCRAGE AVEC TÔLE MICE - CE OPT.1

ANKER MIT FEINBLECH - CE OPT.1



CÓDIGO CODE CODE	MEDIDA SIZE MESURE m.m.	BROCA DRILL FORET m.m.	PA. (Nm.)	*WLL.		EMBALAJE QUANTITY EMBALLAGE		PRECIO TARIFA PRICE LIST PRIX TARIFS PREIS TARIF €/100 U.
				EXTRACCIÓN TENSION LOAD EXTRACTION (kN)	CIZALLADO SHEAR LOAD CISAILLEMENT (kN)			
SNH108080	8x80	8	20	4,16	8,00	100	500	75,30
SNH108110	8x110	8	20	4,16	8,00	50	500	105,00
SNH110070	10x70	10	45	5,00	13,33	25	125	83,40
SNH110095	10x95	10	45	5,00	13,33	50	250	98,37
SNH110125	10x125	10	45	5,00	13,33	50	250	129,47
SNH110145	10x145	10	45	5,00	13,33	15	75	155,00
SNH112115	12x115	12	60	8,88	23,33	15	75	153,13
SNH112145	12x145	12	60	8,88	23,33	50	250	201,67
SNH112165	12x165	12	60	8,88	23,33	25	125	243,23
SNH116130	16x130	16	110	16,66	40,00	25	125	385,20
SNH116145	16x145	16	110	16,66	40,00	20	100	409,70
SNH116165	16x165	16	110	16,66	40,00	20	100	498,07
SNH116225	16x225	16	110	16,66	40,00	10	50	599,80
SNH120170	20x170	20	200	26,60	63,33	15	75	880,83
SNH120200	20x200	20	200	26,60	63,33	15	75	1.014,63

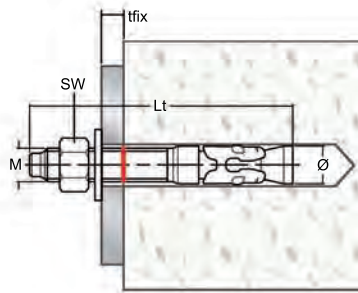

**ANCLAJE ANILLA SN HOMOLOGADO - CE OPCIÓN 7**

WEDGE ANCHOR - CE OPT.7

GOUJON D'ANCRAGE AVEC TÔLE MICE - CE OPT.7

ANKER MIT FEINBLECH - CE OPT.7



CÓDIGO CODE CODE	MEDIDA SIZE MESURE m.m.	BROCA DRILL FORET m.m.	PA. (Nm.)	*WLL.		EMBALAJE QUANTITY EMBALLAGE		PRECIO TARIFA PRICE LIST PRIX TARIFS PREIS TARIF €/100 U.
				EXTRACCIÓN TENSION LOAD EXTRACTION (kN)	CIZALLADO SHEAR LOAD CISAILLEMENT (kN)			
SNH08080	8x80	8	15	5,00	9,02	100		42,87
SNH08100	8x100	8	15	5,00	9,02	100		53,33
SNH08120	8x120	8	15	5,00	9,02	50		57,17
SNH10080	10x80	10	25	8,00	14,28	50		57,17
SNH10090	10x90	10	25	8,00	14,28	50		61,93
SNH10120	10x120	10	25	8,00	14,28	50		72,40
SNH10140	10x145	10	25	8,00	14,28	25		87,64
SNH10160	10x160	10	25	8,00	14,28	25		99,07
SNH12110	12x110	12	45	10,66	22,55	25		93,33
SNH12140	12x140	12	45	10,66	22,55	25		110,50
SNH12160	12x160	12	45	10,66	22,55	25		133,33
SNH16125	16x125	16	110	16,66	41,35	20		179,07
SNH16150	16x150	16	110	16,66	41,35	20		192,40
SNH16175	16x175	16	110	16,66	41,35	10		232,40

\* COEFICIENTE DE SEGURIDAD ETAG INCLUIDO / ETAG SAFETY FACTOR INCLUDED / \* COEFFICIENT DE SÉCURITÉ ETAG INCLUS / \* SICHERHEITSAKTOR ENTHALTEN ETAG

WLL.: CARGA MÁXIMA ADMISIBLE, PA.: PAR DE APRIETE. / WLL.: MAXIMUM ALLOWABLE LOAD. PA.: TORQUE / WLL.: CHARGE MAXIMALE ADMISIBLE. PA.: COUPLE DE SERRAGE

## ANCLAJE HEMBRA SH CINCADO

ZINC PLATED DROP-IN ANCHOR  
CHEVILLE DE FRAPPE EN ACIER ZINGUÉ  
VERZINKTER DÜBEL MIT INNENKONUS, ZU HÄMMERN



CÓDIGO CODE CODE	MÉTRICA METRICS MÉTRIQUE	BROCA DRILL FORET	LARGO LENGTH LONGUEUR	*WLL.  (kN)	EMBALAJE QUANTITY EMBALLAGE		PRECIO TARIFA PRICE LIST PRIX TARIFS PREIS TARIF €/100 u.
SHZ06	M 6	8	25	3,36	100	3.000	10,00
SHZ08	M 8	10	30	4,07	100	1.600	14,47
SHZ10	M10	12	40	4,80	50	800	24,17
SHZ12	M12	15	50	5,82	50	400	44,37
SHZ16	M16	20	65	10,09	25	200	107,20
SHZ20	M20	25	80	15,39	20	200	280,97

## ANCLAJE HEMBRA SH COLLARÍN CINCADO

ZINC PLATED DROP-IN ANCHOR WITH COLLARD  
CHEVILLE DE FRAPPE EN ACIER ZINGUÉ AVEC COLLERETE  
VERZINKTER DÜBEL MIT SAUM UND INNENKONUS, ZU HÄMMERN



CÓDIGO CODE CODE	MÉTRICA METRICS MÉTRIQUE	BROCA DRILL FORET	LARGO LENGTH LONGUEUR	*WLL.  (kN)	EMBALAJE QUANTITY EMBALLAGE		PRECIO TARIFA PRICE LIST PRIX TARIFS PREIS TARIF €/100 u.
SHCZ06	M 6	8	25	3,36	100	3.000	18,83
SHCZ08	M 8	10	30	4,07	100	1.600	18,93
SHCZ10	M10	12	40	4,80	50	800	34,30
SHCZ12	M12	15	50	5,82	50	400	60,97
SHCZ16	M16	20	65	10,09	25	200	137,17

## ANCLAJE HEMBRA SH HOMOLOGADO

DROP IN ANCHOR CE APPROVED  
CHEVILLE DE FRAPPE AVEC AGRÉMENT TECHNIQUE  
VERZINKTER DÜBEL MIT INNENKONUS, ZU HÄMMERN - ETA-CE ZUGELASSEN

HASTA AGOTAR EXISTENCIAS



CÓDIGO CODE CODE	MÉTRICA METRICS MÉTRIQUE	BROCA DRILL FORET	LARGO LENGTH LONGUEUR	*WLL. -----		EMBALAJE QUANTITY EMBALLAGE		PRECIO TARIFA PRICE LIST PRIX TARIFS PREIS TARIF €/100 u.
				EXTRACCIÓN TENSION LOAD EXTRACTION (kN)	DIZALLADO SHEAR LOAD DISAILLEMENT (kN)			
SHH08	M 8	10	33	10,2	6,1	100	1.000	26,67
SHH10	M10	12	44	13,2	7,9	50	500	43,33
SHH12	M12	15	54	23,2	13,9	50	300	69,47
SHH16	M16	20	71	67,1	33,5	25	75	135,00
SHH20	M20	25	86	106,4	53,2	25	50	384,93

## EXPANSIONADOR MANUAL

MANUAL SETTING TOOL  
OUTIL POUSSOIR  
WERKZEUG FÜR DIE MONTAGE DE DÜBELS, ZU HÄMMERN



CÓDIGO CODE CODE	MÉTRICA METRICS MÉTRIQUE	EMBALAJE QUANTITY EMBALLAGE		PRECIO TARIFA PRICE LIST PRIX TARIFS PREIS TARIF €/100 u.
EM06	M 6	1	10	166,67
EM08	M 8	1	10	166,67
EM10	M10	1	10	166,67
EM12	M12	1	10	375,00
EM16	M16	1	10	625,00
EM20	M20	1	10	1.000,00

\* COEFICIENTE DE SEGURIDAD ETAG INCLUIDO / ETAG SAFETY FACTOR INCLUDED / \* COEFFICIENT DE SÉCURITÉ ETAG INCLUS / \* SICHERHEITSAKTOR ENTHALTEN ETAG  
WLL.: CARGA MÁXIMA ADMISIBLE, PA.: PAR DE APRIETE. / WLL.: MAXIMUM ALLOWABLE LOAD. PA.: TORQUE / WLL.: CHARGE MAXIMALE ADMISIBLE. PA.: COUPLE DE SERRAGE

**ANCLAJE ANILLA SN INOXIDABLE A-2**

STAINLESS STEEL AISI 304 WEDGE ANCHOR  
GOUJON D'ANCRAGE AVEC TÔLE MICE EN ACIER INOX. A-2  
ANKER MIT FEINBLECH - EDELSTAHL A-2



CÓDIGO CODE CODE	MEDIDA SIZE MESURE	BROCA DRILL FORET	PA.  (Nm.)	*WLL.		EMBALAJE QUANTITY EMBALLAGE		PRECIO TARIFA PRICE LIST PRIX TARIFS PREIS TARIF €/100 U.
	m.m.	m.m.		EXTRACCIÓN TENSION LOAD EXTRACTION (kN)	CIZALLADO SHEAR LOAD CISAILLEMENT (kN)			
SNA206065	6x65	6	10	3,2	1,7	100	1.200	136,87
SNA206120	6x120	6	10	3,2	1,7	100	800	152,80
SNA206140	6x140	6	10	3,2	1,7	100	800	230,80
SNA208080	8x80	8	20	4,9	3,7	100	800	180,00
SNA208090	8x90	8	20	4,9	3,7	100	800	206,67
SNA210075	10x75	10	40	6,1	4,4	50	400	263,33
SNA210090	10x90	10	40	6,1	4,4	50	400	286,67
SNA210120	10x120	10	40	6,1	4,4	50	300	350,00
SNA212080	12x80	12	50	9,2	9,0	50	300	383,33
SNA212090	12x90	12	50	9,2	9,0	50	300	384,67
SNA212110	12x110	12	50	9,2	9,0	50	300	416,67
SNA212140	12x140	12	50	9,2	9,0	50	300	506,67
SNA216125	16x125	16	125	14,5	22,2	25	150	882,57
SNA216150	16x150	16	125	14,5	22,2	25	150	1.020,00
SNA220170	20x170	20	250	21,5	34,5	10	60	1.679,67
SNA220215	20x215	20	250	21,5	34,5	10	30	1.979,93

**ANCLAJE ANILLA SN INOXIDABLE A-4 HOMOLOGADO**

STAINLESS STEEL AISI 304 WEDGE ANCHOR - CE APPROVED  
GOUJON D'ANCRAGE AVEC TÔLE MICE EN ACIER INOX. A-4 - AGRÉMENT TECHNIQUE  
ANKER MIT FEINBLECH - EDELSTAHL A-4 - ETA-CE ZUGELASSEN



CÓDIGO CODE CODE	MEDIDA SIZE MESURE	BROCA DRILL FORET	PA.  (Nm.)	*WLL.		EMBALAJE QUANTITY EMBALLAGE		PRECIO TARIFA PRICE LIST PRIX TARIFS PREIS TARIF €/100 U.
	m.m.	m.m.		EXTRACCIÓN TENSION LOAD EXTRACTION (kN)	CIZALLADO SHEAR LOAD CISAILLEMENT (kN)			
SNA406065	6x65	6	10	3,2	1,7	100	1.200	162,50
SNA408075	8x75	8	20	5	8,94	100	800	192,67
SNA410075	10x75	10	40	8	14,21	50	400	373,40
SNA410090	10x90	10	40	8	14,21	50	400	399,53
SNA410120	10x120	10	40	8	14,21	50	300	464,40
SNA412080	12x80	12	50	-	20,60	50	300	492,00
SNA412110	12x110	12	50	-	20,60	50	300	569,87
SNA412160	12x160	12	50	-	20,60	25	150	702,70
SNA416145	16x145	16	125	23,33	38,34	25	150	1.340,20
SNA420170	20x170	20	150	23,33	38,34	10	60	2.100,00

**ANCLAJE HEMBRA SH INOXIDABLE A-2**

STAINLESS STEEL AISI 304 DROP IN ANCHOR  
CHEVILLE DE FRAPPE EN ACIER INOX. A-2  
EDELSTAHL A-2 DÜBEL MIT INNENKONUS, ZU HÄMMERN



CÓDIGO CODE CODE	MÉTRICA METRICS MÉTRIQUE	BROCA DRILL FORET	LARGO LENGTH LONGUEUR	*WLL.		EMBALAJE QUANTITY EMBALLAGE		PRECIO TARIFA PRICE LIST PRIX TARIFS PREIS TARIF €/100 U.
	m.m.	m.m.	EXTRACCIÓN TENSION LOAD EXTRACTION (kN)	CIZALLADO SHEAR LOAD CISAILLEMENT (kN)				
SHA206	M 6	8	25	1,7	2,0	100	3.000	75,00
SHA208	M 8	10	30	2,7	3,7	100	1.200	107,17
SHA210	M10	12	40	3,5	5,8	50	800	192,87
SHA212	M12	15	50	4,5	8,4	50	400	342,87
SHA216	M16	20	65	6,0	14,6	25	200	750,00

\* COEFICIENTE DE SEGURIDAD ETAG INCLUIDO / ETAG SAFETY FACTOR INCLUDED / \* COEFFICIENT DE SÉCURITÉ ETAG INCLUS / \* SICHERHEITSAKTOR ENTHALTEN ETAG  
WLL.: CARGA MÁXIMA ADMISIBLE, PA.: PAR DE APRIETE. / WLL.: MAXIMUM ALLOWABLE LOAD. PA.: TORQUE / WLL.: CHARGE MAXIMALE ADMISIBLE. PA.: COUPLE DE SERRAGE



## ANCLAJE HEMBRA SH INOXIDABLE A-4

STAINLESS STEEL AISI 316 DROP IN ANCHOR

CHEVILLE DE FRAPPE EN ACIER INOX. A-4

EDELSTAHL A-4 DÜBEL MIT INNENKONUS, ZU HÄMMERN



CÓDIGO CODE CODE	MÉTRICA METRICS MÉTRIQUE	BROCA DRILL FORET	LARGO LENGTH LONGUEUR	*WLL.		EMBALAJE		PRECIO TARIFA PRICE LIST PRIX TARIFS PREIS TARIF €/100 U.
				EXTRACCIÓN TENSION LOAD EXTRACTION (kN)	QIZALLADO SHEAR LOAD DISAILLEMENT (kN)	QUANTITY EMBALLAGE	QUANTITY EMBALLAGE	
SHA406	M 6	8	25	1,7	2,0	100	3.000	105,00
SHA408	M 8	10	30	2,7	3,7	100	1.200	165,00
SHA410	M10	12	40	3,5	5,8	50	800	310,73
SHA412	M12	15	50	4,5	8,4	50	400	535,73
SHA416	M16	20	65	6,0	14,6	25	200	1.071,43

## ANCLAJE TORNILLO GRANDES CARGAS SZ 8.8

HIGHLOADS STEEL ANCHOR GRADE 8.8

CHEVILLE MÉTALLIQUE POUR CHARGES LOURDES AVEC VIS TÊTE HEXAGONALE CLASSE 8.8

SCHWERLASTANKER MIT SECHSKANTSCHRAUBE KLASSE 8.8

HASTA AGOTAR EXISTENCIAS



CÓDIGO CODE CODE	MEDIDA SIZE MESURE	MÉTRICA METRICS MÉTRIQUE	LARGO LENGTH LONGUEUR	PA.	*WLL.		EMBALAJE		PRECIO TARIFA PRICE LIST PRIX TARIFS PREIS TARIF €/100 U.
					EXTRACCIÓN TENSION LOAD EXTRACTION (kN)	QIZALLADO SHEAR LOAD DISAILLEMENT (kN)	QUANTITY EMBALLAGE	QUANTITY EMBALLAGE	
	Ø x La / t <sub>fx</sub> (m.m.)		m.m.	(Nm.)					
SZ1220	12x90/20	M 8	90	17	4,8	15,4	25	25	248,60
SZ1250	12x120/50	M 8	120	17	4,8	15,4	25	25	347,93
SZ1520	15x100/20	M10	100	34	7,9	22,9	20	20	377,50
SZ1550	15x130/50	M10	130	34	7,9	22,9	20	20	403,63
SZ1825	18x125/25	M12	125	60	11,9	32,6	20	20	557,73
SZ1850	18x150/50	M12	150	60	11,9	32,6	20	20	588,10
SZ1870	18x177/70	M12	177	80	11,9	32,6	20	20	824,10
SZ2425	24x140/25	M16	140	150	16,7	49,1	10	10	1.381,10
SZ2450	24x165/50	M16	165	150	16,7	49,1	10	10	1.502,97

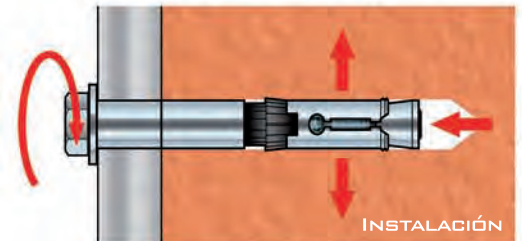
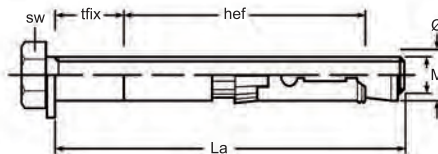

## ANCLAJE TORNILLO GRANDES CARGAS SZ1 - CE OPCIÓN 1

HIGHLOADS STEEL ANCHOR GRADE 8.8 - CE OPT.1

CHEVILLE MÉTALLIQUE POUR CHARGES LOURDES AVEC VIS TÊTE HEXAGONALE CLASSE 8.8 - CE OPT.1

SCHWERLASTANKER MIT SECHSKANTSCHRAUBE KLASSE 8.8 - CE OPT.1

NUEVO / NEW / NEUF / NEU



CÓDIGO CODE CODE	MEDIDA SIZE MESURE	MÉTRICA METRICS MÉTRIQUE	LLAVE KEY CLÉ	PA.	*WLL.		EMBALAJE		PRECIO TARIFA PRICE LIST PRIX TARIFS PREIS TARIF €/100 U.
					EXTRACCIÓN TENSION LOAD EXTRACTION (kN)	QIZALLADO SHEAR LOAD DISAILLEMENT (kN)	QUANTITY EMBALLAGE	QUANTITY EMBALLAGE	
	Ø x La / t <sub>fx</sub> (m.m.)			(Nm.)					
SZ112080	12x80/10	M 8	13	30	10,60	16,66	50	250	271,40
SZ112100	12x100/30	M 8	13	30	10,60	16,66	25	250	285,20
SZ112120	12x120/50	M 8	13	30	10,60	16,66	25	250	322,83
SZ112140	12x140/70	M 8	13	30	10,60	16,66	25	250	400,00
SZ116100	16x100/20	M10	17	50	13,33	28,66	20	200	414,83
SZ116120	16x120/40	M10	17	50	13,33	28,66	20	100	468,37
SZ116140	16x140/60	M10	17	50	13,33	28,66	20	100	545,90
SZ116160	16x160/80	M10	17	50	13,33	28,66	20	100	645,97
SZ118120	18x120/20	M12	19	100	23,33	38,66	10	100	608,63
SZ118150	18x150/50	M12	19	100	23,33	38,66	10	50	728,67
SZ118170	18x170/70	M12	19	100	23,33	38,66	10	50	856,17
SZ118200	18x200/100	M12	19	100	23,33	38,66	10	50	1.121,20
SZ124140	24x140/20	M16	24	160	30,00	71,33	5	25	1.319,23
SZ124170	24x170/50	M16	24	160	30,00	71,33	5	25	1.614,73
SZ124200	24x200/80	M16	24	160	30,00	71,33	5	25	1.866,33



\* COEFICIENTE DE SEGURIDAD ETAG INCLUIDO / ETAG SAFETY FACTOR INCLUDED / \* COEFFICIENT DE SÉCURITÉ ETAG INCLUS / \* SICHERHEITSAKTOR ENTHALTEN ETAG

WLL.: CARGA MÁXIMA ADMISIBLE, PA.: PAR DE APRIETE. / WLL.: MAXIMUM ALLOWABLE LOAD. PA.: TORQUE / WLL.: CHARGE MAXIMALE ADMISIBLE. PA.: COUPLE DE SERRAGE

**GRAPA VENTILADA INOXIDABLE A-2**

STAINLESS STEEL AISI 304 STAPLE  
CRAMPON POUR MORTIER EN ACIER INOX. A-2  
HEFTKLAMMER AUS EDELSTAHL A-2



CÓDIGO CODE CODE	MEDIDA SIZE MESURE m.m.	EMBALAJE QUANTITY EMBALLAGE 	PRECIO TARIFA PRICE LIST PRIX TARIFS PREIS TARIF €/100 U.
GAP08120	8x120	1.000	389,14
GAP08130	8x130	1.000	406,06
GAP08150	8x150	1.000	439,90
GAP08160	8x160	1.000	451,18
GAP08180	8x180	1.000	490,66
GAP08200	8x200	1.000	518,86
GAP10120	10x120	1.000	501,94
GAP10130	10x130	1.000	524,50
GAP10150	10x150	1.000	563,97
GAP10160	10x160	1.000	603,45
GAP10180	10x180	1.000	648,57
GAP10200	10x200	1.000	710,61
GAP10220	10x220	1.000	806,48

PASO 1: PERFORAR LA PARED Y APLICAR LA RESINA  
STEP 1: DRILL THE WALL AND APPLY THE RESIN  
ÉTAPE 1: PERCER LE MUR ET APPLIQUER LA RÉSINE

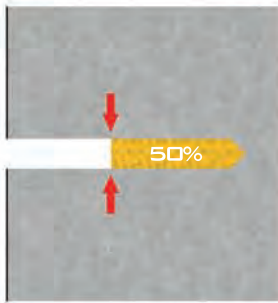

PASO 2: INSERTAR LA GRAPA  
STEP 2: INSERT THE STAPLE  
ÉTAPE 2: INSÉREZ LE CRAMPON

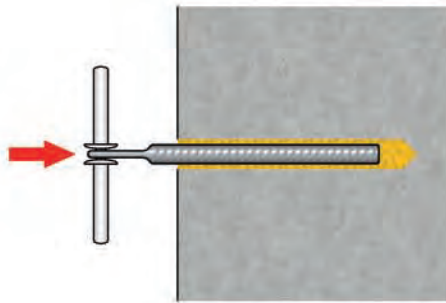

PASO 3: COLOCAR LAS PIEZAS DE LA CUBIERTA  
STEP 3: PLACE THE PIECES OF THE COVER  
ÉTAPE 3: PLACEZ LES PIÈCES DE LE CAPOT

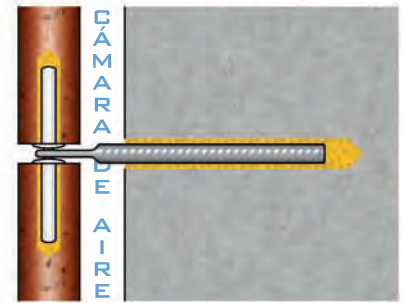

**GRAPA PARA AMORTERAR "Z" INOXIDABLE AISI 302**

STAINLESS STEEL AISI 302 STAPLE "Z"  
CRAMPON POUR MORTIER "Z" EN ACIER INOX. AISI 302  
HEFTKLAMMER "Z" AUS EDELSTAHL AISI 302



CÓDIGO CODE CODE	MODELO MODEL MODÈLE	MEDIDA SIZE MESURE m.m.	EMBALAJE QUANTITY EMBALLAGE 	PRECIO TARIFA PRICE LIST PRIX TARIFS PREIS TARIF €/100 U.
GAS	SIMPLE / SINGLE / SIMPLE	2,5x70	1.000	25,93
GAD	DOBLE / DOUBLE / DOUBLE	2,5x70	1.000	42,59

FABRICADO EN ACERO INOXIDABLE TEMPLADO Y ENDURECIDO PARA OBTENER LA MÁXIMA RESISTENCIA A LA CIZALLADURA.

MADE OF HARDENED STAINLESS STEEL FOR MAXIMUM SHEAR STRENGTH.

FABRIQUÉ EN ACIER INOXIDABLE TREMPÉ ET DURCI POUR MAXIMALE RÉSTISTANCE DE CISAILEMENT.

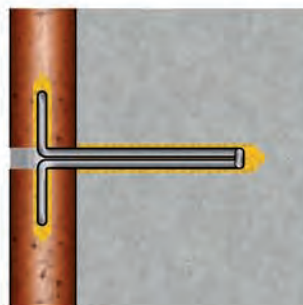

INSTALACIÓN DE LA GAD ENTRE LAS PIEZAS DE LA CUBIERTA  
GAS INSTALLING BETWEEN THE PIECES OF THE COVER  
INSTALLATION DU GAD ENTRE LES PIÈCES DE LA COUVERTURE

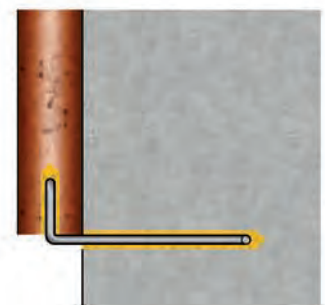

INSTALACIÓN DE LA GAS EN LAS PIEZAS FINALES DE LA CUBIERTA  
GAS INSTALLING IN THE FINAL PIECES OF THE COVER  
INSTALLATION DU GAS DANS LES DERNIÈRES PIÈCES DU COUVERTURE

## CÁPSULA METAL + TORNILLO DIN 933

METAL LOOSE BOLT

CHEVILLE À DOUILLE EN ACIER AVEC VIS DIN 933

HÜLSENANKER MIT SECHSKANTSCHRAUBE DIN 933

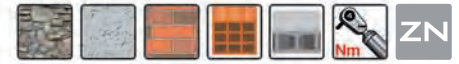

CÓDIGO CODE CODE	MEDIDA SIZE MESURE	BROCA DRILL FORET	*WLL.		EMBALAJE QUANTITY EMBALLAGE		PRECIO TARIFA PRICE LIST PRIX TARIFS PREIS TARIF €/100 U.
			EXTRACCIÓN TENSION LOAD EXTRACTION (KN)	CIZALLADO SHEAR LOAD CISAILLEMENT (KN)			
MCT06	6x45	11	9,98	2,60	100	1.200	31,33
MCT08	8x60	14	12,50	4,50	50	300	54,00
MCT10	10x70	16	20,10	6,10	50	300	81,40
MCT12	12x80	20	45,30	10,50	25	150	131,13

## CÁPSULA METAL ESPÁRRAGO

METAL THREADED ROD BOLT

CHEVILLE À DOUILLE EN ACIER AVEC TIGE FILETEÉ

HÜLSENANKER MIT GEWINDESTANGE

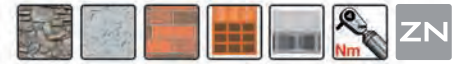

CÓDIGO CODE CODE	MEDIDA SIZE MESURE	BROCA DRILL FORET	*WLL.		EMBALAJE QUANTITY EMBALLAGE		PRECIO TARIFA PRICE LIST PRIX TARIFS PREIS TARIF €/100 U.
			EXTRACCIÓN TENSION LOAD EXTRACTION (KN)	CIZALLADO SHEAR LOAD CISAILLEMENT (KN)			
MCE06	6x45	11	9,98	2,60	100	1.200	38,90
MCE08	8x60	14	12,50	4,50	50	300	62,20
MCE10	10x70	16	20,10	6,10	25	300	92,67
MCE12	12x80	20	45,30	10,50	20	150	182,33

## CÁPSULA METAL ARO

METAL EYE BOLT

CHEVILLE À DOUILLE EN ACIER AVEC PITON

HÜLSENANKER MIT AUGENSCHRAUBE



CÓDIGO CODE CODE	MEDIDA SIZE MESURE	BROCA DRILL FORET	*WLL.		EMBALAJE QUANTITY EMBALLAGE		PRECIO TARIFA PRICE LIST PRIX TARIFS PREIS TARIF €/100 U.
			EXTRACCIÓN TENSION LOAD EXTRACTION (KN)	CIZALLADO SHEAR LOAD CISAILLEMENT (KN)			
MCA06	6x45	11	9,98	2,60	100	600	63,33
MCA08	8x60	14	12,50	4,50	50	300	86,67
MCA10	10x70	16	20,10	6,10	25	150	126,67
MCA12	12x80	20	45,30	10,50	20	120	223,33

## CÁPSULA METAL GANCHO

METAL HOOK BOLT

CHEVILLE À DOUILLE EN ACIER AVEC CROCHET

HÜLSENANKER MIT RUNDHAKEN

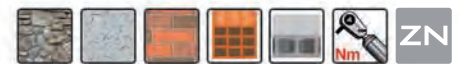

CÓDIGO CODE CODE	MEDIDA SIZE MESURE	BROCA DRILL FORET	*WLL.		EMBALAJE QUANTITY EMBALLAGE		PRECIO TARIFA PRICE LIST PRIX TARIFS PREIS TARIF €/100 U.
			EXTRACCIÓN TENSION LOAD EXTRACTION (KN)	CIZALLADO SHEAR LOAD CISAILLEMENT (KN)			
MCG06	6x45	11	9,98	2,60	100	600	63,33
MCG08	8x60	14	12,50	4,50	50	300	86,67
MCG10	10x70	16	20,10	6,10	25	150	126,67
MCG12	12x80	20	45,30	10,50	20	120	223,33

## CÁPSULA METAL

METAL SHIELD

CHEVILLE À DOUILLE EN ACIER

HÜLSENANKER



CÓDIGO CODE CODE	MEDIDA SIZE MESURE	BROCA DRILL FORET	EMBALAJE QUANTITY EMBALLAGE		PRECIO TARIFA PRICE LIST PRIX TARIFS PREIS TARIF €/100 U.
MC06	6x45	11	100	1.200	26,67
MC08	8x60	14	100	600	41,20
MC10	10x70	16	50	300	62,93
MC12	12x80	20	25	150	121,40

\* RECOMENDAMOS APLICAR UN COEFICIENTE DE SEGURIDAD "4" / \* WE RECOMMEND APPLYING A SAFETY FACTOR OF "4"

/ \* NOUS RECOMMANDONS D'APPLIQUER UN FACTEUR DE DE SÉCURITÉ "4" / \* WIR EMPFEHLEN DIE ANWENDUNG EINES SICHERHEITSAKTORS VON "4"

WLL.: CARGA MÁXIMA ADMISIBLE, PA.: PAR DE APRIETE. / WLL.: MAXIMUM ALLOWABLE LOAD. PA.: TORQUE / WLL.: CHARGE MAXIMALE ADMISIBLE. PA.: COUPLE DE SERRAGE

**ZAMAK TORNILLO DIN 933**

SLEEVE ANCHOR ZAMAK WITH UNLOSABLE NUT AND HEX. HEAD SCREW DIN 933  
CHEVILLE À DOUILLE ZAMAK AVEC CÔNE FIXE ET VIS TÊTE HEXAGONALE DIN 933  
HÜLSENANKER MIT FESTEM KONUS UND SECHSKANTSCHRAUBE DIN 933

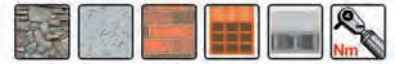

CÓDIGO CODE CODE	MEDIDA SIZE MESURE m.m.	BROCA DRILL FORET m.m.	*WLL.		EMBALAJE QUANTITY EMBALLAGE		PRECIO TARIFA PRICE LIST PRIX TARIFS PREIS TARIF €/100 U.
			EXTRACCIÓN TENSION LOAD EXTRACTION (kN)	CIZALLADO SHEAR LOAD DISAILLEMENT (kN)	100	1.200	
ZT06	6x45	12	9,98	2,60	100	1.200	80,00
ZT08	8x60	14	12,50	4,50	50	300	106,67
ZT10	10x70	16	20,10	6,10	50	300	153,33
ZT12	12x80	20	45,30	10,50	25	150	250,00

**ZAMAK ESPÁRRAGO**

SLEEVE ANCHOR ZAMAK WITH UNLOSABLE NUT AND THREADED RODS  
CHEVILLE À DOUILLE ZAMAK AVEC CÔNE FIXE ET TIGE FILETÉE  
HÜLSENANKER MIT FESTEM KONUS UND GEWINDESTANGE

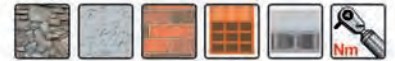

CÓDIGO CODE CODE	MEDIDA SIZE MESURE m.m.	BROCA DRILL FORET m.m.	*WLL.		EMBALAJE QUANTITY EMBALLAGE		PRECIO TARIFA PRICE LIST PRIX TARIFS PREIS TARIF €/100 U.
			EXTRACCIÓN TENSION LOAD EXTRACTION (kN)	CIZALLADO SHEAR LOAD DISAILLEMENT (kN)	100	1.200	
ZE06	6x45	12	9,98	2,60	100	1.200	86,67
ZE08	8x60	14	12,50	4,50	50	300	130,00
ZE10	10x70	16	20,10	6,10	50	300	173,33
ZE12	12x80	20	45,30	10,50	25	150	286,67

**ZAMAK ARO**

SLEEVE ANCHOR ZAMAK WITH UNLOSABLE NUT AND EYE  
CHEVILLE À DOUILLE ZAMAK AVEC CÔNE FIXE ET PITON  
HÜLSENANKER MIT FESTEM KONUS UND AUGENSCHRAUBE



CÓDIGO CODE CODE	MEDIDA SIZE MESURE m.m.	BROCA DRILL FORET m.m.	*WLL.		EMBALAJE QUANTITY EMBALLAGE		PRECIO TARIFA PRICE LIST PRIX TARIFS PREIS TARIF €/100 U.
			EXTRACCIÓN TENSION LOAD EXTRACTION (kN)	CIZALLADO SHEAR LOAD DISAILLEMENT (kN)	100	600	
ZA06	6x45	12	9,98	2,60	100	600	96,67
ZA08	8x60	14	12,50	4,50	50	300	140,00
ZA10	10x70	16	20,10	6,10	25	150	193,33
ZA12	12x80	20	45,30	10,50	25	120	306,67

**ZAMAK GANCHO**

SLEEVE ANCHOR ZAMAK WITH UNLOSABLE NUT AND HOOK  
CHEVILLE À DOUILLE ZAMAK AVEC CÔNE FIXE ET CROCHET  
HÜLSENANKER MIT FESTEM KONUS UND RUNDHAKEN



CÓDIGO CODE CODE	MEDIDA SIZE MESURE m.m.	BROCA DRILL FORET m.m.	*WLL.		EMBALAJE QUANTITY EMBALLAGE		PRECIO TARIFA PRICE LIST PRIX TARIFS PREIS TARIF €/100 U.
			EXTRACCIÓN TENSION LOAD EXTRACTION (kN)	CIZALLADO SHEAR LOAD DISAILLEMENT (kN)	100	600	
ZG06	6x45	12	9,98	2,60	100	600	96,67
ZG08	8x60	14	12,50	4,50	50	300	140,00
ZG10	10x70	16	20,10	6,10	25	150	193,33
ZG12	12x80	20	45,30	10,50	25	120	306,67

**ZAMAK CÁPSULA**

SLEEVE ANCHOR ZAMAK WITH UNLOSABLE NUT  
CHEVILLE À DOUILLE ZAMAK AVEC CÔNE FIXE  
HÜLSENANKER MIT FESTEM KONUS



CÓDIGO CODE CODE	MEDIDA SIZE MESURE m.m.	BROCA DRILL FORET m.m.	EMBALAJE QUANTITY EMBALLAGE		PRECIO TARIFA PRICE LIST PRIX TARIFS PREIS TARIF €/100 U.
			100	1.200	
ZC06	6x45	12	100	1.200	62,40
ZC08	8x60	14	100	600	76,67
ZC10	10x70	16	50	300	103,33
ZC12	12x80	20	25	150	166,67

\* RECOMENDAMOS APLICAR UN COEFICIENTE DE SEGURIDAD "4" / \* WE RECOMMEND APPLYING A SAFETY FACTOR OF "4"  
/ \* NOUS RECOMMANDONS D'APPLIQUER UN FACTEUR DE DE SÉCURITÉ "4" / \* WIR EMPFEHLEN DIE ANWENDUNG EINES SICHERHEITSAKTORS VON "4"  
WLL.: CARGA MÁXIMA ADMISIBLE, PA.: PAR DE APRIETE. / WLL.: MAXIMUM ALLOWABLE LOAD. PA.: TORQUE / WLL.: CHARGE MAXIMALE ADMISIBLE. PA.: COUPLE DE SERRAGE



## TACO DE LATÓN

KNURLED BRASS ANCHOR  
CHEVILLE EN LAITON MOLETÉÉ  
GÉRANDELTER DÜBEL AUS MESSING



CÓDIGO CODE CODE	MÉTRICA METRICS MÉTRIQUE	BROCA DRILL FORET	LARGO LENGTH LONGUEUR	*WLL.*		EMBALAJE QUANTITY EMBALLAGE		PRECIO TARIFA PRICE LIST PRIX TARIFS PREIS TARIF €/100 U.
				EXTRACCIÓN TENSION LOAD EXTRACTION (kN)	CIZALLADO SHEAR LOAD CISAILLEMENT (kN)			
TL04	M 4	5	16	2,55	3,06	200	5.000	7,67
TL05	M 5	6,5	20	3,57	4,08	100	5.000	10,87
TL06	M 6	8	24	4,49	5,10	100	5.000	16,63
TL08	M 8	10	28	5,71	7,14	100	2.500	29,33
TL10	M10	12	32	8,98	9,19	100	1.200	50,00

\* RECOMENDAMOS APLICAR UN COEFICIENTE DE SEGURIDAD "4" / \* WE RECOMMEND APPLYING A SAFETY FACTOR OF "4"  
/ \* NOUS RECOMMANDONS D'APPLIQUER UN FACTEUR DE DE SÉCURITÉ "4" / \* WIR EMPFEHLEN DIE ANWENDUNG EINES SICHERHEITSAKTORS VON "4"

## TACO DE LATÓN CON COLLARÍN

KNURLED BRASS ANCHOR WITH COLLARD  
CHEVILLE EN LAITON MOLETÉÉ AVEC COLLERETTE  
GÉRANDELTER DÜBEL AUS MESSING MIT SAUM



CÓDIGO CODE CODE	MÉTRICA METRICS MÉTRIQUE	BROCA DRILL FORET	LARGO LENGTH LONGUEUR	*WLL.*		EMBALAJE QUANTITY EMBALLAGE		PRECIO TARIFA PRICE LIST PRIX TARIFS PREIS TARIF €/100 U.
				EXTRACCIÓN TENSION LOAD EXTRACTION (kN)	CIZALLADO SHEAR LOAD CISAILLEMENT (kN)			
TLC08	M 8	10	35	5,71	7,14	100	2.500	66,67

\* RECOMENDAMOS APLICAR UN COEFICIENTE DE SEGURIDAD "4" / \* WE RECOMMEND APPLYING A SAFETY FACTOR OF "4"  
/ \* NOUS RECOMMANDONS D'APPLIQUER UN FACTEUR DE DE SÉCURITÉ "4" / \* WIR EMPFEHLEN DIE ANWENDUNG EINES SICHERHEITSAKTORS VON "4"

## CONJUNTO PARA PISCINA

POOL SET  
SET POUR PISCINE  
SCHWIMMBAD SET



CPM  
CP

CÓDIGO CODE CODE	MÉTRICA METRICS MÉTRIQUE	MODELO MODEL MODÈLE	BROCA DRILL FORET	LARGO LENGTH LONGUEUR	EMBALAJE QUANTITY EMBALLAGE		PRECIO TARIFA PRICE LIST PRIX TARIFS PREIS TARIF €/100 U.
CP	M 8	ROSCA COMPLETA / FULL THREAD / FILETAGE COMPLET	10	35	100	1.200	115,11
CPM	M 8	MEDIA ROSCA / HALF THREAD / MOITIÉ FILETAGE	10	35	100	1.200	134,00

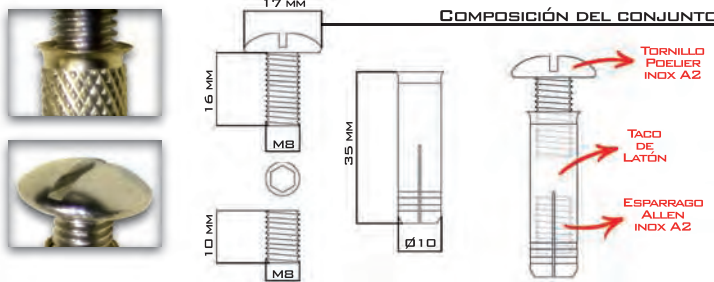

## TACO PARA PISCINA ESCAMOTEABLE

RETRACTABLE POOL SET  
SET POUR PISCINE ESCAMOTABLE  
SCHWIMMBAD SET EINZIEHBAR



CÓDIGO CODE CODE	MEDIDA SIZE MESURE	BROCA DRILL FORET	Ø CABEZA Ø HEAD Ø TÊTE	EMBALAJE QUANTITY EMBALLAGE		PRECIO TARIFA PRICE LIST PRIX TARIFS PREIS TARIF €/100 U.
TPE	6X60	10	14	100	1.200	266,67

WLL.: CARGA MÁXIMA ADMISIBLE, PA.: PAR DE APRIETE. / WLL.: MAXIMUM ALLOWABLE LOAD. PA.: TORQUE / WLL.: CHARGE MAXIMALE ADMISIBLE. PA.: COUPLE DE SERRAGE

**TORNILLO DIRECTO HORMIGÓN**

DIRECT FIXING SCREW FOR CONCRETE  
VIS DE FIXATION DIRECTE POUR LE BÉTON  
GERADE-BETONSCHRAUBE

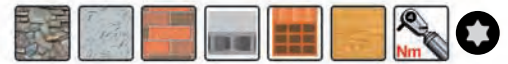

CÓDIGO CODE CODE	MEDIDA SIZE MESURE	BROCA DRILL FORET	LLAVE KEY CLÉ	EMBALAJE QUANTITY EMBALLAGE		PRECIO TARIFA PRICE LIST PRIX TARIFS PREIS TARIF €/100 u.
	m.m.	m.m.				
TH075080	7,5x80	6	T-30	100	100	22,33
TH075092	7,5x92	6	T-30	100	100	27,33
TH075112	7,5x112	6	T-30	100	100	35,00
TH075132	7,5x132	6	T-30	100	100	39,57
TH075152	7,5x152	6	T-30	100	100	51,67
TH075182	7,5x182	6	T-30	100	100	71,60

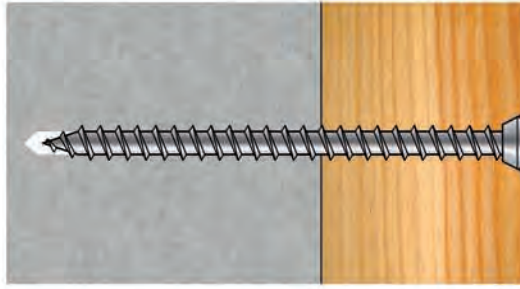

SECCIÓN DE LA INSTALACIÓN

**TORNILLO DIRECTO HORMIGÓN HEXAGONAL**

DIRECT FIXING SCREW FOR CONCRETE WITH HEXAGONAL HEAD  
VIS DE FIXATION DIRECTE POUR LE BÉTON AVEC TÊTE HEXAGONAL  
GERADE-SECHSKANTBETONSCHRAUBE

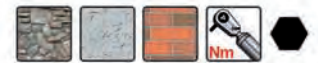

CÓDIGO CODE CODE	MEDIDA SIZE MESURE	BROCA DRILL FORET	PROF. MÍNIMA T. MIN. HOLE DEPTH PROF. MIN. TROU	ESPESOR A FIJAR THICKNESS TO FIX ÉPAISSEUR	PA.	LLAVE KEY CLÉ	EMBALAJE QUANTITY EMBALLAGE		PRECIO TARIFA PRICE LIST PRIX TARIFS PREIS TARIF €/100 u.
	m.m.	m.m.	m.m.	m.m.	(Nm.)				
THE075060	7,5x60	6	40	20	25	10	100	600	41,93
THE075080	7,5x80	6	40	45	25	10	100	600	47,33
THE100060	10x60	8	55	20	40	13	100	800	60,60
THE100080	10x80	8	55	35	40	15	50	300	65,40
THE100100	10x100	8	55	60	40	15	50	300	81,03
THE100140	10x140	8	55	110	40	15	50	300	116,67
THE120070	12x70	10	70	25	50	17	50	300	121,83
THE120090	12x90	10	70	50	50	17	25	250	144,10
THE120110	12x110	10	70	70	50	17	25	150	171,53
THE120130	12x130	10	70	90	50	17	25	150	212,93
THE120150	12x150	10	70	100	50	17	25	150	286,67

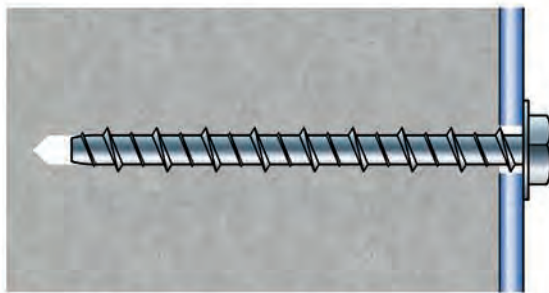

SECCIÓN DE LA INSTALACIÓN

## TLLO. DIRECTO HORMIGÓN HEX. HOMOLOGADO ZN - CE OPCIÓN 1

NUEVO / NEW / NEUF / NEU

ZINC PLATED HEXAGONAL FLANGED WASHER HEAD WITH SERRATION CONCRETE SCREW - CE OPT.1  
 VIS ZINGUÉ À BÉTON BREVETÉE TÊTE HEXAGONALE À EMBASE AVEC RONDELLE INTÉGRÉE MOLETÉE - CE OP.1  
 SECHSKANT-BETONSCHRAUBE MIT GERÄNDELTER UNTERLEGSSCHEIBE MIT FLANSCH, VERZINKT - CE OPT.1



CÓDIGO CODE CODE	MEDIDA SIZE MEASURE	BROCA DRILL FORET	PROF. MÍNIMA T. MIN. HOLE DEPTH PROF. MIN. TROU	ESPESOR A FIJAR THICKNESS TO FIX ÉPAISSEUR	PA.	LLAVE KEY CLÉ	EMBALAJE QUANTITY EMBALLAGE	PRECIO TARIFA PRICE LIST PRIX TARIFS PREIS TARIF €/100 U.
	m.m.	m.m.	m.m.	m.m.	(Nm.)			
THEH08080	8x80	6	80	20	20	10	50	92,30
THEH08100	8x100	6	80	40	20	10	50	99,20
THEH08120	8x120	6	80	60	20	10	50	106,97
THEH08140	8x140	6	80	80	20	10	50	132,40
THEH10080	10x80	8	95	10	50	13	50	137,20
THEH10100	10x100	8	95	30	50	13	25	140,87
THEH10120	10x120	8	95	50	50	13	25	152,30
THEH10140	10x140	8	95	70	50	13	25	180,60
THEH10160	10x160	8	95	90	50	13	25	185,07
THEH12090	12x90	10	110	10	80	15	25	168,10
THEH12110	12x110	10	110	30	80	15	25	186,07
THEH12130	12x130	10	110	50	80	15	25	211,40
THEH12150	12x150	10	110	70	80	15	25	228,30
THEH12190	12x190	10	110	110	80	15	20	344,27
THEH12210	12x210	10	110	130	80	15	20	356,50
THEH12250	12x250	10	110	170	80	15	15	453,53
THEH12290	12x290	10	110	210	80	15	15	530,83

## TORNILLO DIRECTO HORMIGÓN DOBLE ROSCA ZN - CE OPCIÓN 1

NUEVO / NEW / NEUF / NEU

ZINC PLATED DUAL THREAD CONCRETE SCREW WITH HEX. SHANK WITH NUT AND WASHER - CE OPT.1  
 VIS ZINGUÉ À BÉTON DOUBLE FILET AVEC QUEUE HEXAGONALE, AVEC ÉCROU ET RONDELLE - CE OP.1  
 DOPPELGEWINDE-BETONSCHRAUBE MIT SECHSKANTCHAFT, MIT MUTTER UND SCHEIBE, VERZINKT - CE OPT.1



CÓDIGO CODE CODE	MEDIDA SIZE MEASURE	BROCA DRILL FORET	PROF. MÍNIMA T. MIN. HOLE DEPTH PROF. MIN. TROU	ESPESOR A FIJAR THICKNESS TO FIX ÉPAISSEUR	PA.	LLAVE KEY CLÉ	EMBALAJE QUANTITY EMBALLAGE	PRECIO TARIFA PRICE LIST PRIX TARIFS PREIS TARIF €/100 U.
	m.m.	m.m.	m.m.	m.m.	(Nm.)			
HXB08090	M- 8x90	6	75	10	20	13	100	167,00
HXB08120	M- 8x120	6	75	40	20	13	100	185,10
HXB08160	M- 8x160	6	75	80	20	13	50	214,07
HXB10105	M-10x105	8	90	10	50	17	50	220,00
HXB10125	M-10x125	8	90	30	50	17	50	235,77
HXB10195	M-10x195	8	90	100	50	17	25	324,87
HXB12118	M-12x118	10	100	10	80	19	25	308,00
HXB12138	M-12x138	10	100	30	80	19	25	345,27
HXB12208	M-12x208	10	100	100	80	19	25	560,00

## TLLO. DIRECTO HORMIGÓN CABEZA ABOMBADA SST - CE PENDIENTE

NUEVO / NEW / NEUF / NEU

MUSHROOM HEAD WITH SERRATION CONCRETE SCREW, SST - CE PENDING.  
 VIS À BÉTON BREVETÉE TÊTE RONDE EMPREINTE 6 LOBES MOLETÉE SOUS LA TÊTE, SST - ATTENTE DE LA CE  
 RUNDKOPF-BETONSCHRAUBE INNENSECHSRUND, MIT GERÄNDELTER UNTERKOPF - VORBEHALTLICH DER CE



CÓDIGO CODE CODE	MEDIDA SIZE MEASURE	BROCA DRILL FORET	PROF. MÍNIMA T. MIN. HOLE DEPTH PROF. MIN. TROU	ESPESOR A FIJAR THICKNESS TO FIX ÉPAISSEUR	PA.	LLAVE KEY CLÉ	EMBALAJE QUANTITY EMBALLAGE	PRECIO TARIFA PRICE LIST PRIX TARIFS PREIS TARIF €/100 U.
	m.m.	m.m.	m.m.	m.m.	(Nm.)			
HXT08060	8x60	6	65	10	20	T30	100	53,33
HXT08080	8x80	6	75	20	20	T30	50	65,73
HXT08100	8x100	6	75	40	20	T30	50	75,20
HXT08120	8x120	6	75	60	20	T30	50	98,33
HXT10060	10x60	8	70	10	50	T40	50	94,20
HXT10080	10x80	8	90	10	50	T40	50	114,97
HXT10100	10x100	8	90	30	50	T40	25	131,07
HXT10120	10x120	8	90	50	50	T40	25	158,17

CE PENDIENTE  
 CE PENDING  
 ATTENTE DE LA CE

WLL.: CARGA MÁXIMA ADMISIBLE, PA.: PAR DE APRIETE. / WLL.: MAXIMUM ALLOWABLE LOAD. PA.: TORQUE / WLL.: CHARGE MAXIMALE ADMISIBLE. PA.: COUPLE DE SERRAGE

**TORNILLO HORMIGÓN CABEZA AVELLANADA ZN - CE OPCIÓN 1**

NUEVO / NEW / NEUF / NEU

ZINC PLATED FLAT CSK HEAD WITH RIBS CONCRETE SCREW - CE OPT.1

VIS ZINGUÉ À BÉTON BREVETÉE TÊTE FRAISÉE PLATE AVEC NERVURES SOUS LA TÊTE - CE OPT.1

SENKKOPF-BETONSCHRAUBE MIT FRÄSRIPPEN, VERZINKT - CE OPT.1



CÓDIGO Code Code	MEDIDA SIZE MEASURE	BROCA DRILL FORET	PROF. MÍNIMA T. MIN. HOLE DEPTH PROF. MIN. TROU	ESPESOR A FIJAR THICKNESS TO FIX ÉPAISSEUR	PA.	LLAVE KEY CLÉ	EMBALAJE QUANTITY EMBALLAGE	PRECIO TARIFA PRICE LIST PRIX TARIFS PREIS TARIF €/100 U.
	m.m.	m.m.	m.m.	m.m.	(Nm.)			
HXS08070	8x70	6	75	10	20	T30	100	97,87
HXS08100	8x100	6	75	40	20	T30	50	116,77
HXS08140	8x140	6	75	80	20	T30	25	164,54
HXS10080	10x80	8	90	10	50	T40	50	162,00
HXS10100	10x100	8	90	30	50	T40	50	172,00
HXS10160	10x160	8	90	90	50	T40	25	252,30
HXS12100	12x100	10	100	20	80	T50	25	245,00
HXS12120	12x120	10	100	40	80	T50	25	265,00
HXS12180	12x180	10	100	100	80	T50	25	514,00

**MANGUITO SEPARADOR HEXAGONAL**

HEXAGONAL STEEL COUPLING NUTS

MANCHON HEXAGONAL

SECHSKANTÜBERWURFMUTTERN



CÓDIGO Code Code	MEDIDA SIZE MEASURE	∅ DIÁMETRO EXTERIOR ∅ OUTSIDE DIAMETER ∅ DIAMÈTRE EXTÉRIEUR	EMBALAJE QUANTITY EMBALLAGE		PRECIO TARIFA PRICE LIST PRIX TARIFS PREIS TARIF €/100 U.
	m.m.	m.m.			
MSE06020	6x20	10	200	1.200	15,13
MSE06030	6x30	10	200	1.200	19,43
MSE08020	8x20	11	200	1.200	18,20
MSE08030	8x30	11	200	1.200	20,00
MSE10030	10x30	12	200	1.200	29,07
MSE12035	12x35	17	200	1.200	49,17

**MANGUITO SEPARADOR REDONDO**

ROUNDED STEEL COUPLING NUTS

MANCHON CYLINDRIQUE

RUNDENÜBERWURFMUTTERN



CÓDIGO Code Code	MEDIDA SIZE MEASURE	∅ DIÁMETRO EXTERIOR ∅ OUTSIDE DIAMETER ∅ DIAMÈTRE EXTÉRIEUR	EMBALAJE QUANTITY EMBALLAGE		PRECIO TARIFA PRICE LIST PRIX TARIFS PREIS TARIF €/100 U.
	m.m.	m.m.			
MS04020	4x20	8	200	1.200	12,10
MS06020	6x20	10	200	1.200	12,73
MS06030	6x30	10	200	1.200	17,80
MS08020	8x20	11	200	1.200	18,20
MS08030	8x30	11	200	1.200	19,43
MS10030	10x30	12	200	1.200	21,43
MS12035	12x35	15	200	1.200	32,83



## ANCLAJE RESINA POLIESTER

POLYESTER RESIN ANCHOR  
CHEVILLE RÉSINE POLYESTER  
POLIESTERHARZ-ANKER

CÓDIGO / CODE / CODE:  
POLI410  
CONTENIDO / CONTENT / CONTENU:  
410ML.  
EMBALAJE / QUANTITY / EMBALLAGE:  
12

PRECIO TARIFA  
PRICE LIST / PRIX TARIFS:  
1.266,67 €/100 U.  
UNIDAD / UNIT / UNITÉ:  
12,67 €/U.



CÁNULA INCLUIDA  
STATIC MIXER INCLUDED  
CANULE INCLUS

## ANCLAJE RESINA POLIESTER SIN ESTIRENO

FREE STYRENE POLYESTER RESIN ANCHOR  
CHEVILLE RÉSINE POLYESTER SANS STYRÈNE  
POLIESTERHARZ-ANKER STYROLFREI

CÓDIGO / CODE / CODE:  
POLIS300 / POLIS410  
CONTENIDO / CONTENT / CONTENU:  
300ML. / 410ML.  
EMBALAJE / QUANTITY / EMBALLAGE:  
12 / 12

PRECIO TARIFA  
PRICE LIST / PRIX TARIFS:  
300ML.: 1.333,33 €/100 U.  
410ML.: 1.426,67 €/100 U.

UNIDAD / UNIT / UNITÉ:  
300ML.: 13,33 €/U.  
410ML.: 14,27 €/U.



STYRENE FREE 300ML 410ML



CÁNULA INCLUIDA  
STATIC MIXER INCLUDED  
CANULE INCLUS

## ANCLAJE RESINA EPOXYACRILATO

EPOXYACRYLATE RESIN ANCHOR  
CHEVILLE RÉSINE EPOXYACRYLATE  
EPOXIDHARZ-ANKER

CÓDIGO / CODE / CODE:  
EPOX300 / EPOX410  
CONTENIDO / CONTENT / CONTENU:  
300ML. / 410ML.  
EMBALAJE / QUANTITY / EMBALLAGE:  
12 / 12

PRECIO TARIFA  
PRICE LIST / PRIX TARIFS:  
300ML.: 1.450,00 €/100 U.  
410ML.: 1.500,00 €/100 U.

UNIDAD / UNIT / UNITÉ:  
300ML.: 14,50 €/U.  
410ML.: 15,00 €/U.



300ML 410ML



CÁNULA INCLUIDA  
STATIC MIXER INCLUDED  
CANULE INCLUS

## ANCLAJE RESINA VINILESTER SIN ESTIRENO

FREE STYRENE VINYLESTER RESIN ANCHOR  
CHEVILLE RÉSINE VINILESTER SANS STYRÈNE  
VINILESTERHARZ-ANKER STYROLFREI

CÓDIGO / CODE / CODE:  
VINIE300 / VINIE410  
CONTENIDO / CONTENT / CONTENU:  
300ML. / 410ML.  
EMBALAJE / QUANTITY / EMBALLAGE:  
12 / 12

PRECIO TARIFA  
PRICE LIST / PRIX TARIFS:  
300ML.: 1.566,67 €/100 U.  
410ML.: 1.633,33 €/100 U.

UNIDAD / UNIT / UNITÉ:  
300ML.: 15,67 €/U.  
410ML.: 16,33 €/U.



NUEVO / NEW / NEUF / NEU  
STYRENE FREE 300ML 410ML



CÁNULA INCLUIDA  
STATIC MIXER INCLUDED  
CANULE INCLUS

## ANCLAJE RESINA VINILESTER PLUS SIN ESTIRENO

FREE STYRENE VINYLESTER PLUS RESIN ANCHOR  
CHEVILLE RÉSINE VINILESTER PLUS SANS STYRÈNE  
VINILESTERPLUS HARZ-ANKER STYROLFREI

CÓDIGO / CODE / CODE:  
VINI410  
CONTENIDO / CONTENT / CONTENU:  
410ML.  
EMBALAJE / QUANTITY / EMBALLAGE:  
12

PRECIO TARIFA  
PRICE LIST / PRIX TARIFS:  
1.808,63 €/100 U.  
UNIDAD / UNIT / UNITÉ:  
18,09 €/U.



STYRENE FREE 410ML



CÁNULA INCLUIDA  
STATIC MIXER INCLUDED  
CANULE INCLUS

CE - VARILLA CORRUGADA / DE - REBAR / CE - BARRES D'ARMATURE

**PISTOLAS PARA RESINA**

HAND GUNS FOR RESIN  
PISTOLETS POUR RÉSINE  
HANDPISTOLE FÜR HARZ

**410ML**

**ECONÓMICA**



**CÓDIGO / CODE / CODE:**  
PRA  
**MODELO / MODEL / MODÈLE:**  
ECONÓMICA  
**TAMAÑO / SIZE / CALIBRE:**  
380-410ML.  
**EMBALAJE**  
QUANTITY / EMBALLAGE:  
12   
**PRECIO TARIFA**  
PRICE LIST / PRIX TARIFS:  
**3.166,67 €/100 U.**  
**UNIDAD / UNIT / UNITÉ:**  
**31,67 €/U.**

**CÓDIGO / CODE / CODE:**  
PR  
**MODELO / MODEL / MODÈLE:**  
GAMA MEDIA  
**TAMAÑO / SIZE / CALIBRE:**  
380-410ML.  
**EMBALAJE**  
QUANTITY / EMBALLAGE:  
12   
**PRECIO TARIFA**  
PRICE LIST / PRIX TARIFS:  
**5.186,70 €/100 U.**  
**UNIDAD / UNIT / UNITÉ:**  
**51,87 €/U.**



**GAMA MEDIA**

**PROFESIONAL**



**CÓDIGO / CODE / CODE:**  
PRP  
**MODELO / MODEL / MODÈLE:**  
PROFESIONAL  
**TAMAÑO / SIZE / CALIBRE:**  
380-410ML.  
**EMBALAJE**  
QUANTITY / EMBALLAGE:  
10   
**PRECIO TARIFA**  
PRICE LIST / PRIX TARIFS:  
**14.044,00 €/100 U.**  
**UNIDAD / UNIT / UNITÉ:**  
**140,44 €/U.**

**CÓDIGO / CODE / CODE:**  
PRS  
**MODELO / MODEL / MODÈLE:**  
STAR  
**TAMAÑO / SIZE / CALIBRE:**  
380-410ML.  
**EMBALAJE**  
QUANTITY / EMBALLAGE:  
12   
**PRECIO TARIFA**  
PRICE LIST / PRIX TARIFS:  
**6.666,67 €/100 U.**  
**UNIDAD / UNIT / UNITÉ:**  
**66,67 €/U.**



**STAR**

**SISTEMA DE REDUCCIÓN DE ESFUERZO**  
STRESS  
REDUCTION SYSTEM  
SYSTÈME DE RÉDUCTION DU STRESS

**SISTEMA DE APERTURA RÁPIDO**  
QUICK OPENING  
SYSTEM  
SYSTÈME D'OUVERTURE RAPIDE

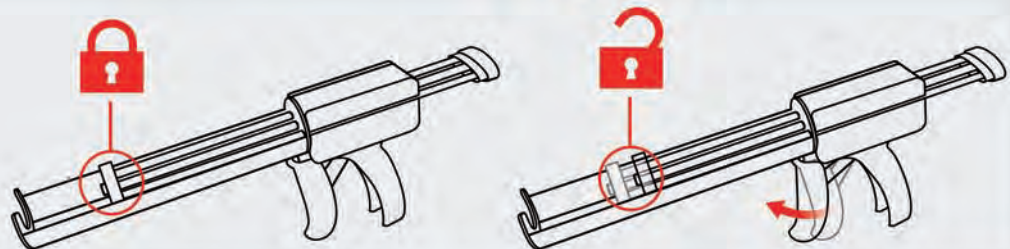

**HASTA AGOTAR EXISTENCIAS**



## PISTOLAS NEUMÁTICAS Y ELÉCTRICAS PARA RESINA

PNEUMATIC & ELECTRIC GUNS FOR RESIN  
 PISTOLET PNEUMATIQUE ET ÉLECTRIQUE POUR RÉSINE  
 DRUCKLUFTPUMPE FÜR HARZ

410ML

### ELÉCTRICA



MALETÍN INCLUIDO

BATERÍA DE GRAN CAPACIDAD

**CÓDIGO / CODE / CODE:**  
PRB  
**MODELO / MODEL / MODÈLE:**  
PISTOLA ELÉCTRICA  
**TAMAÑO / SIZE / CALIBRE:**  
380-410ML.  
**EMBALAJE**  
**QUANTITY / EMBALLAGE:**  
1  
**PRECIO TARIFA**  
**PRICE LIST / PRIX TARIFS:**  
106.888,90 €/100 U.  
**UNIDAD / UNIT / UNITÉ:**  
1.068,89 €/U.

**CÓDIGO / CODE / CODE:**  
PRNE  
**MODELO / MODEL / MODÈLE:**  
NEUMÁTICA ECONÓMICA  
**TAMAÑO / SIZE / CALIBRE:**  
380-410ML.  
**EMBALAJE**  
**QUANTITY / EMBALLAGE:**  
1  
**PRECIO TARIFA**  
**PRICE LIST / PRIX TARIFS:**  
62.642,87 €/100 U.  
**UNIDAD / UNIT / UNITÉ:**  
626,43 €/U.

### NEUMÁTICA ECONÓMICA



### NEUMÁTICA



**CÓDIGO / CODE / CODE:**  
PRN  
**MODELO / MODEL / MODÈLE:**  
PISTOLA NEUMÁTICA  
**TAMAÑO / SIZE / CALIBRE:**  
380-410ML.  
**EMBALAJE**  
**QUANTITY / EMBALLAGE:**  
1  
**PRECIO TARIFA**  
**PRICE LIST / PRIX TARIFS:**  
138.095,27 €/100 U.  
**UNIDAD / UNIT / UNITÉ:**  
1.380,95 €/U.

## PISTOLAS PARA SILICONA

GUNS FOR SILICON  
 PISTOLET POUR SILICONE  
 HANDPISTOLE FÜR SILICON

300ML

### SKELETON



**CÓDIGO / CODE / CODE:**  
PSS  
**MODELO / MODEL / MODÈLE:**  
SKELETON  
**TAMAÑO / SIZE / CALIBRE:**  
280-310ML.  
**EMBALAJE**  
**QUANTITY / EMBALLAGE:**  
24  
**PRECIO TARIFA**  
**PRICE LIST / PRIX TARIFS:**  
974,00 €/100 U.  
**UNIDAD / UNIT / UNITÉ:**  
9,74 €/U.

**CÓDIGO / CODE / CODE:**  
PSG  
**MODELO / MODEL / MODÈLE:**  
GIRATORIA  
**TAMAÑO / SIZE / CALIBRE:**  
280-310ML.  
**EMBALAJE**  
**QUANTITY / EMBALLAGE:**  
24  
**PRECIO TARIFA**  
**PRICE LIST / PRIX TARIFS:**  
1.533,33 €/100 U.  
**UNIDAD / UNIT / UNITÉ:**  
15,33 €/U.



### GIRATORIA

### STAR



SISTEMA DE REDUCCIÓN DE ESFUERZO  
 STRESS  
 REDUCTION SYSTEM  
 SYSTÈME DE RÉDUCTION DU STRESS

SISTEMA DE APERTURA RÁPIDO  
 QUICK OPENING  
 SYSTEM  
 SYSTÈME D'OUVERTURE RAPIDE

**CÓDIGO / CODE / CODE:**  
PSST  
**MODELO / MODEL / MODÈLE:**  
STAR  
**TAMAÑO / SIZE / CALIBRE:**  
280-310ML.  
**EMBALAJE**  
**QUANTITY / EMBALLAGE:**  
12  
**PRECIO TARIFA**  
**PRICE LIST / PRIX TARIFS:**  
6.666,67 €/100 U.  
**UNIDAD / UNIT / UNITÉ:**  
66,67 €/U.

HASTA AGOTAR EXISTENCIAS

## BOQUILLA PARA RESINA

STATIC MIXER FOR CHEMICAL CARTRIDGES  
CANULE MÉLANGEUSE POUR RÉSINE  
STATISCHE MISCHER FÜR HARZ



CÓDIGO CODE CODE	MEDIDA SIZE MESURE	EMBALAJE QUANTITY EMBALLAGE		PRECIO TARIFA PRICE LIST PRIX TARIFS PREIS TARIF €/100 U.
BO12	m.m. 215	12	96	86,67
BO	215	100	1.000	83,30

ESPIRAL INTERIOR PARA MEZCLAR  
INNER SPIRAL FOR MIXING  
SPIRALE INTÉRIEURE POUR MÉLANGER



## CEPILLO LIMPIADOR

BRUSH  
BROSSE  
KLEIDERBÜRSTE



CÓDIGO CODE CODE	MEDIDA SIZE MESURE	EMBALAJE QUANTITY EMBALLAGE	PRECIO TARIFA PRICE LIST PRIX TARIFS PREIS TARIF €/100 U.
C1	8/10	 1	1.386,67
C2	10/14	 1	1.386,67
C3	16/28	 1	1.386,67

## BOMBA DE SOPLADO

BLOWER PUMP  
POMPE SOUFFLANTE  
AUSBLASPUMPE

**\*HASTA AGOTAR EXISTENCIAS**

CÓDIGO CODE CODE	MEDIDA SIZE MESURE	EMBALAJE QUANTITY EMBALLAGE		MODELO MODEL MODÈLE	PRECIO TARIFA PRICE LIST PRIX TARIFS PREIS TARIF €/100 U.
BOMBAP	PULGADAS / INCH 8"	1	24	BOMBA SOPLADO 8"	1.233,33
BOMBA*	14"	1	24	BOMBA SOPLADO 14"	2.000,00



## MALETÍN DE RESINA PROFESIONAL

PROFESIONAL RESIN CASE  
SEVIETTE ET RÉSINE PROFESSIONAL  
PROFESSIONAL CASE FÜR HARZ



CONTENIDO / CONTENT / CONTENU :

- 1 - PISTOLA / HANDGUN / PISTOLÈT PRA
- 2 - CARTUCHOS DE RESINA / RESIN CARTRIDGES / CARTOUCHES DE RÉSINE 410ML.
- 10 - TÁMICES / SLEEVES / PASSOIRES 12x80
- 10 - ESPÁRRAGOS / RODS / TIGE FILETÉE M-BX100
- 5 - BOQUILLAS / STATIC MIXERS / CANULES

CÓDIGO CODE CODE	MODELO MODEL MODÈLE	PRECIO TARIFA PRICE LIST PRIX TARIFS PREIS TARIF €/100 U.
MP	POLIESTER	9.344,00
ME	EPOXI	10.014,00
MV	VINILESTER	10.953,00
MPS410	POLI. S/ESTIRENO 410ML. 2 CARTUCHOS	9.660,00
MPS	POLI. S/ESTIRENO 300ML. 4 CARTUCHOS	13.339,00

## MALETÍN DE RESINA "TRAILBOX"

TRAILBOX RESIN CASE  
SEVIETTE ET RÉSINE TRAILBOX  
TRAILBOX CASE FÜR HARZ

**NUEVO / NEW / NEUF / NEU**



CONTENIDO / CONTENT / CONTENU :

- 1 - PISTOLA / HANDGUN / PISTOLÈT PRS
- 12 - CARTUCHOS DE RESINA / RESIN CARTRIDGES / CARTOUCHES DE RÉSINE 410ML.
- 20 - TÁMICES / SLEEVES / PASSOIRES 15x85
- 20 - ESPÁRRAGOS / RODS / TIGE FILETÉE M-10x110
- 24 - BOQUILLAS / STATIC MIXERS / CANULES
- 1 - BOMBA SOPLADO / BLOWER PUMP / POMPE SOUFFLANTE 8"
- 1 - CEPILLO / BRUSH / BROSSE Nº1
- 1 - CEPILLO / BRUSH / BROSSE Nº2
- 1 - CEPILLO / BRUSH / BROSSE Nº3

CÓDIGO CODE CODE	MODELO MODEL MODÈLE	PRECIO TARIFA PRICE LIST PRIX TARIFS PREIS TARIF €/U.	PRECIO TARIFA PRICE LIST PRIX TARIFS PREIS TARIF €/100 U.
MPCO	POLIESTER	350,00	35.000,00
MPSC	POLIESTER S/EST.	370,00	37.000,00

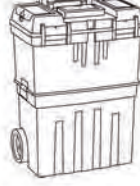
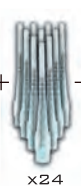

MEDIDAS / SIZE / MESURE:  
470 x 290 x 630 MM.  
MATERIAL / MATERIAL / MATÉRIEL:  
PP



## ANCLAJE HEMBRA PARA RESINA

STEEL BUSH WITH INTERNAL THREAD FOR CHEMICAL ANCHOR  
MANCHON AVEC FILETAGE INTERIEUR POUR ANCRAGE CHIMIQUE  
INNENGEWINDEHÜLSE FÜR CHEMISCHE VERANKERUNG



CÓDIGO CODE CODE	MEDIDA SIZE MESURE m.m.	BROCA DRILL FORET m.m.	LARGO LENGTH LONGUEUR m.m.	EMBALAJE QUANTITY EMBALLAGE		PRECIO TARIFA PRICE LIST PRIX TARIFS PREIS TARIF €/100 U.
SHR08	8x80	14	80	50	600	130,00
SHR10	10x80	16	80	50	600	143,33
SHR12	12x80	18	80	25	300	166,67

## TAMIZ

PERFORATED SLEEVE FOR CHEMICAL ANCHOR  
PASSOIRE POUR ANCRAGE CHIMIQUE  
SIEBHÜLSE FÜR CHEMISCHE VERANKERUNG



CÓDIGO CODE CODE	MEDIDA SIZE MESURE m.m.	BROCA DRILL FORET m.m.	LARGO LENGTH LONGUEUR m.m.	MÉTRICA METRICS MÉTRIQUE	EMBALAJE QUANTITY EMBALLAGE		PRECIO TARIFA PRICE LIST PRIX TARIFS PREIS TARIF €/100 U.
TA12050	12x50	12	50	M6 / M8	100	600	26,67
TA12080	12x80	12	80	M6 / M8	100	600	26,67
TA15085	15x85	15	85	M8 / M10 / M12	50	300	26,67
TA15130	15x130	15	130	M8 / M10 / M12	50	300	30,00
TA20085	20x85	20	85	M14 / M16	40	240	32,00

## TAMIZ ERIZO

HEDGEHOG PERFORATED SLEEVE FOR CHEMICAL ANCHOR  
PASSOIRE OURSIN POUR ANCRAGE CHIMIQUE  
SIEBHÜLSE FÜR CHEMISCHE VERANKERUNG



CÓDIGO CODE CODE	MEDIDA SIZE MESURE m.m.	BROCA DRILL FORET m.m.	LARGO LENGTH LONGUEUR m.m.	MÉTRICA METRICS MÉTRIQUE	EMBALAJE QUANTITY EMBALLAGE		PRECIO TARIFA PRICE LIST PRIX TARIFS PREIS TARIF €/100 U.
TAE13100	13x100	14	100	M8 / M10	50	300	56,00
TAE15100	15x100	16	100	M10 / M12	50	300	62,50

## VARILLA, TUERCA Y ARANDELA PARA RESINA

ROD, NUT & WASHER FOR CHEMICAL ANCHOR  
TIGE FILETÉE, ECROU ET RONDELLE POUR ANCRAGE CHIMIQUE  
GEWINDESTANGE MIT SECHSKANTMUTTER UND SCHEIBE FÜR CHEMISCHE VERANKERUNG



CÓDIGO CODE CODE	MEDIDA SIZE MESURE m.m.	EMBALAJE QUANTITY EMBALLAGE		PRECIO TARIFA PRICE LIST PRIX TARIFS PREIS TARIF €/100 U.
VRZ06070	6x70	100	1.200	36,67
VRZ08100	8x100	100	1.200	56,67
VRZ10110	10x110	50	600	70,00
VRZ10140	10x140	50	300	89,00
VRZ12115	12x115	50	300	109,67
VRZ16190	16x190	10	100	308,33
VRZ20260	20x260	5	30	663,33

**CÁPSULA QUÍMICA ROTACIÓN SQR**

SPIN IN CHEMICAL ANCHOR CAPSULE  
SCÉLLEMENT CHIMIQUE PAR AMPOULLE DE ROTATION  
VERBUNDANKER



CÓDIGO CODE CODE	MÉTRICA METRICS MÉTRIQUE	BROCA DRILL FORET	EMBALAJE QUANTITY EMBALLAGE		PRECIO TARIFA PRICE LIST PRIX TARIFS PREIS TARIF €/100 U.
SQR08	M 8	10	10	200	176,60
SQR10	M10	12	10	200	176,60
SQR12	M12	14	10	200	186,60
SQR16	M16	18	10	200	206,63
SQR20	M20	25	5	40	426,63
SQR24	M24	28	5	40	499,93

**ESPÁRRAGO QUÍMICO ROTACIÓN SER**

CHEMICAL ANCHOR STUD 45° SLICED, WITH NUT AND WASHER  
TIGE FILETÉE COUPÉE À 45° AVEC ÉCROU ET RONDELLE  
GEWINDESTANGE 45° GESCHNITTEN MIT SCHRAUBENMUTTER UND SCHEIBE



CÓDIGO CODE CODE	MEDIDA SIZE MESURE	BROCA DRILL FORET	EMBALAJE QUANTITY EMBALLAGE		PRECIO TARIFA PRICE LIST PRIX TARIFS PREIS TARIF €/100 U.
SER08110	8x110	10	10	200	86,67
SER10130	10x130	12	10	200	88,98
SER12160	12x160	14	10	200	164,87
SER16190	16x190	18	10	100	308,33
SER20260	20x260	25	5	30	663,33
SER24300	24x300	28	5	10	1.412,87

**ESPÁRRAGO QUÍMICO ROTACIÓN SER INOXIDABLE A-4**

CHEMICAL ANCHOR STUD 45° SLICED, WITH NUT AND WASHER - STAINLESS STEEL AISI 316  
TIGE FILETÉE COUPÉE À 45° AVEC ÉCROU ET RONDELLE - ACIER INOX. A-4  
GEWINDESTANGE 45° GESCHNITTEN MIT SCHRAUBENMUTTER UND SCHEIBE - EDELSTAHL A-4



CÓDIGO CODE CODE	MEDIDA SIZE MESURE	BROCA DRILL FORET	EMBALAJE QUANTITY EMBALLAGE		PRECIO TARIFA PRICE LIST PRIX TARIFS PREIS TARIF €/100 U.
SER408110	8x110	10	10	200	337,80
SER410130	10x130	12	10	200	503,47
SER412160	12x160	14	10	200	777,80
SER416190	16x190	18	10	100	1.500,00
SER420260	20x260	25	5	30	3.218,27
SER424300	24x300	28	5	10	<b>CONSULTAR</b>

**PASO 1:**  
PERFORAR Y LIMPIAR EL AGUJERO.  
DRILL AND CLEAN THE HOLE.  
PERCER ET NETTOYER LE TROU.

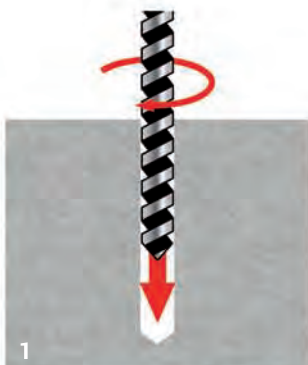

**PASO 2:**  
COLOCAR LA CÁPSULA Y ROMPERLA INTRO-  
DUCIENDO EL ESPÁRRAGO CON UN MOVI-  
MIENTO DE ROTACIÓN.  
PLACE THE CAPSULE AND BREAK IT, ENTE-  
RING THE STUD WITH A ROTATIONAL MOVE-  
MENT.  
PLACER LA CAPSULE ET LE CASSER, EN-  
TRANT DANS LE GOUJON AVEC UN MOUVÉ-  
MENT DE ROTATION.

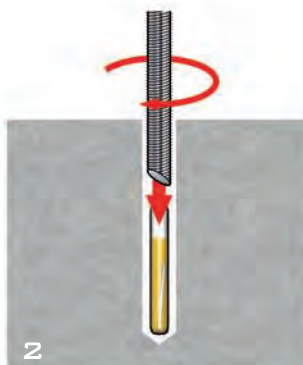

**PASO 3:**  
COLOCAR EL ESPÁRRAGO EN LA POSI-  
CIÓN CORRECTA ANTES DE QUE EL FRA-  
GUADO DE LA CÁPSULA SEA DEFINITIVO.  
PLACING THE STUD IN THE CORRECT POSI-  
TION BEFORE THE CURING OF THE CAPSULE  
TO BE DEFINITIVE.  
PLACER LE GOUJON DANS LA BONNE POSI-  
TION AVANT LE DURCISSEMENT DE LA CAP-  
SULE D'ÊTRE DÉFINITIF.

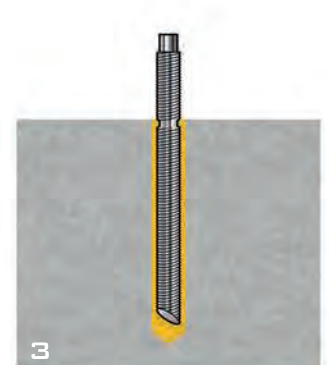

## BOMBA DE SELLADO POR INYECCIÓN

INJECTION PUMP SEAL  
POMPE DE SCELLER POUR INJECTION  
EINSPRITZPUMPEN SEAL

CÓDIGO CODE CODE	EMBALAJE QUANTITY EMBALLAGE	PRECIO TARIFA PRICE LIST PRIX TARIFS PREIS TARIF €/U.	PRECIO TARIFA PRICE LIST PRIX TARIFS PREIS TARIF €/100 U.
AI	1	180	18.000

INYECTA CEMENTO  
DIRECTAMENTE  
EN LA PARED

CEMENT INJECTED  
DIRECTLY  
ON THE WALL

CIMENT INJECTE  
DIRECTEMENT  
SUR LE MUR

SISTEMA PATENTADO  
PATENTED SYSTEM  
SYSTÈME BEVETÉ  
Nº U200/02387



### SISTEMA TRADICIONAL

### TRADITIONAL SYSTEM

### SYSTÈME TRADITIONNEL

CON EL SISTEMA TRADICIONAL ESTAMOS PERDIENDO MUCHO TIEMPO CON LA PALETA Y EL RESULTADO NO ES EL APROPIADO.

WITH THE TRADITIONAL SYSTEM WE ARE LOSING A LOT OF TIME WITH THE PALETTE AND THE RESULT IS NOT APPROPRIATE.

AVEC LE SYSTÈME TRADITIONNEL, NOUS PERDONS BEAUCOUP DE TEMPS AVEC LA PALETTE ET LE RÉSULTAT N'EST PAS APPROPRIÉ.



### NUEVO SISTEMA

### NEW SYSTEM

### NOUVEAU SYSTÈME

ESPECIALMENTE INDICADO PARA TRABAJOS EN SERIE, NOS PERMITE UN AHORRO DE TIEMPO MUY SIGNIFICATIVO, OFRECIENDO A LA VEZ UNA TOTAL GARANTÍA DE MADIZADO.

ESPECIALLY SUITABLE FOR WORKING IN SERIES, ALLOWS US TO SAVE SIGNIFICANT TIME WHILE PROVIDING A COMPLETE CURING WARRANTY.

PARTICULIÈREMENT ADAPTÉ POUR TRAVAILLER EN SÉRIE, NOUS PERMET DE GAGNER UN TEMPS CONSIDÉRABLE TOUT EN OFFRANT UNE GARANTIE TOTALE DE DURCISSEMENT.



## APLICADOR POR INYECCIÓN PARA EL SELLADO DE ORIFICIOS

INJECTION APPLICATOR FOR HOLE SEALING  
APPLICATEUR POUR INJECTION POUR SCELLER LES TROUS

### GAVETA CON MORTERO A BASE DE CEMENTO / DRAWER WITH MORTAR (CEMENT BASED) / TIROIR AVEC MORTIER DE CIMENT



EL APLICADOR SE CARGA DIRECTAMENTE POR ABSORCIÓN; ESTANDO INDICADO PARA TRABAJOS REALIZADOS CON YESO, CEMENTO-COLA, MORTERO Y SIMILARES.

THE APPLICATOR IS LOADED DIRECTLY BY ABSORPTION, BEING SUITABLE FOR WORK DONE WITH PLASTER, TILE ADHESIVE, MORTAR AND THE LIKE.

L'APPLICATEUR EST CHARGÉE DIRECTEMENT PAR ABSORPTION, ÉTANT ADAPTÉ POUR LE TRAVAIL EFFECTUÉ AVEC DU PLÂTRE, COLLE À CARREAUX, MORTIER ET SIMILAIRE.

### INYECCIÓN DIRECTA A LA PARED / DIRECT INJECTION TO THE WALL / INJECTION DIRECTE AU MUR



UNA VEZ CARGADO EL APLICADOR, SE INYECTA DIRECTAMENTE EN EL ORIFICIO EJERCIENDO UNA LIGERA PRESIÓN, CONSIGUIENDO UN PERFECTO LLENADO.

ONCE LOADED THE APPLICATOR, IS INJECTED DIRECTLY INTO THE HOLE EXERCISING SLIGHT PRESSURE, ACHIEVING A PERFECT FILLING.

UNE FOIS CHARGÉ DE L'APPLICATEUR, EST INJECTÉ DIRECTEMENT DANS LE TROU EXERÇANT UNE LÉGÈRE PRESION, OBTENIR UN REMPLISSAGE PARFAIT.

### LIMPIEZA CON AGUA / CLEAN WITH WATER / NETTOYAGE AVEC EAU



EL APLICADOR DISPONE DE UN SISTEMA DE ENGRASE INTERNO, IMPIDIENDO QUE LOS MATERIALES A UTILIZAR SE ADHIERAN EN EL INTERIOR DE LA CÁNULA. ASÍ EL MANTENIMIENTO SE REDUCE A SUMERGIR EL EXTREMO EN AGUA MIENTRAS NO SE UTILIZA.

THE APPLICATOR HAS A SYSTEM OF INTERNAL LUBRICATION, PREVENTING MATERIALS FROM ADHERING TO USE WITHIN THE TUBE. THIS REDUCE THE MAINTENANCE TO IMMERSE THE END IN WATER WHILE NOT IN USE.

L'APPLICATEUR COMPORTE UN SYSTÈME DE LUBRIFICATION INTERNE, CE QUI EMPÊCHE LES MATÉRIAUX DE COLLER À UTILISER À L'INTÉRIEUR DE LA CANULE. L'ENTRETIEN EST RÉDUIT À PLONGER L'EXTRÉMITÉ DE L'EAU LORSQU'IL N'EST PAS UTILISÉ.

LA FIJACIÓN MÁS  
ECONÓMICA

THE CHEAPEST  
FIXING

LES MOINS CHERS  
FIXATION

**SPRAYS DE GALVANIZADO EN FRÍO**

COLD GALVANIZING SPRAY  
SPRAY POUR GALVANISATION À FROID  
SPRAY FÜR COLD GALVANISIERTEM

**ZN**

**SPRAY CINCADO GALVANIZADO / SPRAY FOR ZINC PLATED STEEL / SPRAY POUR ACIER ZINGUÉ**



BASE: CINCADO PURO EN UN 98%  
COMBUSTIBLE: HIDROCARBURO NATURAL INODORO, NO TÓXICO, NO CONTIENE CFC  
COLOR: CINCADO GRIS  
TIEMPO DE SECADO: SECADO RÁPIDO

BASE: PURE ZINC 98%  
FUEL: NATURAL HYDROCARBON ODORLESS, NON-TOXIC, NO CONTAINS CFC  
COLOR: GREY ZINC  
DRYING TIME: FAST DRYING

BASE: ZINGUÉ PURE 98%  
CARBURANT: INODORE HYDROCARBURE NATUREL, NON TOXIQUE, NE CONTIENT PAS DE CFC  
COULEUR: ZINGUÉ GRIS  
TEMPS DE SÉCHAGE: SÉCHAGE RAPIDE

**EMPLEO:**

PROTECTOR ANTIOXIDANTE CON UN ELEVADO CONTENIDO DE CINC PARTICULARMENTE ADAPTADO PARA RETOQUES DE LA SOLDADURA, PARA RESTAURAR CHAPAS DE CINC, PARA CINCAR Y PROTEGER PERNOS, TUERCAS QUE ESTÁN A LA INTEMPERIE DURANTE MUCHO TIEMPO, ETC.

ESTE PRODUCTO FORMA UNA PELÍCULA DE CINC QUE PRESERVA EL MATERIAL FERROSO DE LA OXIDACIÓN Y PUEDE SER BARNIZADO O DEJADO COMO PROTECCIÓN FINAL. RESISTE A LA SAL POR MUCHAS HORAS.

EL SPRAY ESTÁ DOTADO CON UN TAPÓN ANTI-GOTEO QUE EVITA LA SUCIEDAD DURANTE LA UTILIZACIÓN.

**EMPLOYMENT:**

ANTIOXIDANT PROTECTOR WITH HIGH ZINC CONTENT PARTICULARLY ADAPTED FOR TOUCH-WELDING, TO RESTORE PLATES AND PROTECT BOLTS, NUTS THAT ARE OUTDOORS FOR A LONG TIME. THIS PRODUCT FORMS A ZINC FILM TO PRESERVES THE FERROUS MATERIAL OF THE OXIDATION AND MAY BE PAINTED OR LEFT AS END PROTECTION. RESISTS SALT FOR MANY HOURS. THE SPRAY IS PROVIDED WITH AN ANTI-DRIP CAP PREVENTS DIRT DURING USE.

**EMPLI:**

PROTECTEUR ANTI-OXYDANT À HAUTE TENEUR EN ZINC PARTICULIÈREMENT ADAPTÉ POUR TOUCHER SOUDAGE, DE RESTAURER DES PLAQUES DE ZINC POUR LA GALVANISATION ET DE PROTÉGER LES BOULONS, LES ÉCROUS QUI SONT À L'EXTÉRIEUR PENDANT UNE LONGUE PÉRIODE, ETC. CE PRODUIT FORME UN FILM DE ZINC CONSERVE LE MATÉRIAU FERREUX DE L'OXYDATION ET PEUT ÊTRE PEINT OU LAISSÉE TELLE PROTECTION D'EXTRÉMITÉ. RÉSISTE SEL PENDANT PLUSIEURS HEURES. LE PULVÉRISATEUR EST POURVU D'UN CAPUCHON ANTI-GOUTTE EMPÊCHE LA SALETÉ PENDANT L'UTILISATION.

CÓDIGO CODE CODE	CONTENIDO CONTENT CONTENU	EMBALAJE QUANTITY EMBALLAGE	PRECIO TARIFA PRICE LIST PRIX TARIFS PREIS TARIF €/U.	PRECIO TARIFA PRICE LIST PRIX TARIFS PREIS TARIF €/100 U.
SPRAYZ	m.l. 400	 12	12,98	1.297,47

**SPRAY ACERO INOXIDABLE / SPRAY FOR STAINLESS STEEL / SPRAY POUR ACIER INOX.**

**INOX**



BASE: ACERO INOXIDABLE EN VEHÍCULO SINTÉTICO  
COMBUSTIBLE: HIDROCARBURO NATURAL INODORO, NO TÓXICO, NO CONTIENE CFC  
COLOR: METÁLICO  
TIEMPO DE SECADO: SECADO RÁPIDO

BASE: STAINLESS STEEL SYNTHETIC VEHICLE  
FUEL: NATURAL HYDROCARBON ODORLESS, NON-TOXIC, NO CONTAINS CFC  
COLOR: METALLIC  
DRYING TIME: FAST DRYING

BASE: ACIER INOXYDABLE VÉHICULE SYNTHÉTIQUE  
CARBURANT: INODORE HYDROCARBURE NATUREL, NON TOXIQUE, NE CONTIENT PAS DE CFC  
COULEUR: MÉTALLIQUE  
TEMPS DE SÉCHAGE: SÉCHAGE RAPIDE

**EMPLEO:**

HIDRÁULICA, CARPINTERÍA METÁLICA, ASTILLEROS, RETOQUES EN GENERAL.

PROTECCIÓN GALVÁNICA DE LOS EQUIPOS INDUSTRIALES DE HIERRO, CAÑERÍAS, SOLDADURA DE SUPERFICIES ANTERIORMENTE GALVANIZADAS, DEPÓSITOS, ESTRUCTURAS VARIAS, ESTRUCTURAS MARINAS Y ESTRUCTURAS EN ACERO INOX.

FÁCIL APLICACIÓN, SECA RÁPIDAMENTE FORMANDO UNA PELÍCULA FLEXIBLE, COMPACTA Y RESISTENTE QUE PUEDE SER SOBRE BARNIZADA O DEJADA COMO PROTECCIÓN FINAL.

**EMPLOYMENT:**

HYDRAULICS, CARPENTRY, SHIPBUILDING, GENERAL TINKERING. GALVANIC PROTECTION FOR INDUSTRIAL EQUIPMENTS, IRON PIPES, SOLDERS IN GALVANIZED SURFACES, TANKS, SEVERAL STRUCTURES, MARINE STRUCTURES AND STRUCTURES IN STAINLESS STEEL. EASY TO APPLY, DRIES QUICKLY FORMING A FLEXIBLE, COMPACT AND RESISTANT FILM WHICH CAN BE PAINTED OR LEFT AS OF END PROTECTION.

**EMPLI:**

HYDRAULIQUE, LA MENUISERIE, LA CONSTRUCTION NAVALE, LE BRICOLAGE EN GÉNÉRAL. PROTECTION GALVANIQUE DE LES ÉQUIPEMENTS INDUSTRIELS, SOUDURE EN SURFACES GALVANISÉES, PLUSIEURS STRUCTURES, LES OUVRAGES MARITIMES ET DES STRUCTURES EN ACIER INOXYDABLE. FACILE À APPLIQUER, SÉCHAGE RAPIDE FORMANT UN FILM SOUPLE, COMPACT ET RÉSISTANT QUI PEUT ÊTRE PEINT OU VERS LA GAUCHE COMME UNE PROTECTION FINAL.

CÓDIGO CODE CODE	CONTENIDO CONTENT CONTENU	EMBALAJE QUANTITY EMBALLAGE	PRECIO TARIFA PRICE LIST PRIX TARIFS PREIS TARIF €/U.	PRECIO TARIFA PRICE LIST PRIX TARIFS PREIS TARIF €/100 U.
SPRAYA2	m.l. 400	 12	12,98	1.297,47



## BRIDAS DE NYLON POLYAMIDA 6.6 EN BLANCO Y NEGRO

BLACK & WHITE NYLON CABLE TIES  
COLLIERS DE SERRAGE EN NYLON, BLANC ET NOIR  
KABELBINDER AUS NYLON, WEISS UND SCHWARZ



*CÓDIGO *CODE *CODE	MEDIDA SIZE MESURE	Ø MÁX. CIERRE Ø MAX. CLOSURE Ø MAX. FERMETURE	TENSIÓN MAX. MAX. STRESS MAX. TENSION	EMBALAJE QUANTITY EMBALLAGE		PRECIO TARIFA PRICE LIST PRIX TARIFS PREIS TARIF €/100 U.
	m.m.	m.m.	KG.			
BB/BN/0250098	2,5x98	21	8,16	100	30.000	0,78
BB/BN/0260135	2,6x135	32	8,16	100	25.000	1,54
BB/BN/0260160	2,6x160	40	8,16	100	20.000	1,70
BB/BN/0260200	2,6x200	52	8,16	100	20.000	2,16
BB/BN/0360140	3,6x140	35	13	100	30.000	2,04
BB/BN/0360200	3,6x200	50	13	100	12.000	2,87
BB/BN/0360290	3,6x290	80	13	100	13.000	4,37
BB/BN/0360370	3,6x370	103	13	100	8.000	6,53
BB/BN/0450120	4,5x120	40	20	100	25.000	2,73
BB/BN/0450160	4,5x160	24	20	100	10.000	3,29
BB/BN/0480178	4,8x178	45	22	100	10.000	3,43
BB/BN/0480200	4,8x200	50	22	100	10.000	3,44
BB/BN/0480250	4,8x250	68	22	100	10.000	5,33
BB/BN/0480290	4,8x290	79	22	100	10.000	6,00
BB/BN/0480360	4,8x360	103	22	100	8.000	7,22
BB/BN/0480430	4,8x430	115	22	100	5.000	10,90
BB/BN/0780180	7,8x180	45	55	100	5.000	9,00
BB/BN/0780240	7,8x240	63	55	100	4.000	10,67
BB/BN/0780300	7,8x300	80	55	100	4.000	11,20
BB/BN/0780365	7,8x365	100	55	100	3.000	13,67
BB/BN/0780450	7,8x450	130	55	100	2.500	25,20
BB/BN/0780540	7,8x540	130	55	100	2.500	30,82
BB/BN/0780750	7,8x750	200	55	100	1.500	39,93
BB/BN/0900780	9,0x780	233	77	50	1.000	48,67
BB/BN/1260500	12,6x500	143	110	50	1.000	49,37
BB/BN/1260720	12,6x720	213	110	50	1.000	63,27
BB/BN/1260850	12,6x850	255	110	50	1.000	93,59
BB/BN/1261000	12,6x1.000	302	110	50	1.000	93,59

\* BB: BRIDA BLANCA / WHITE CABLE TIE / COLLIER DE SERRAGE EN BLANC / KABELBINDER WEISS  
BN: BRIDA NEGRA / BLACK CABLE TIE / COLLIER DE SERRAGE EN NOIR / KABELBINDER SCHWARZ

## TACO FIJACIÓN PARA BRIDAS DE NYLON

NYLON CABLE TIES WALL PLUG  
TAQUET COLLIER EN NYLON  
MONTAGEDÜBEL AUS NYLON



CÓDIGO CODE CODE	MEDIDA SIZE MESURE	*COLOR *COLOR *COULEUR	BROCA DRILL FORET	EMBALAJE QUANTITY EMBALLAGE		PRECIO TARIFA PRICE LIST PRIX TARIFS PREIS TARIF €/100 U.
	m.m.		m.m.			
TB6	ø6 (7,8x37)	NEGRO / BLACK / NOIR	6	100	5.000	5,47
TB8	ø8 (9x43,5)	NEGRO / BLACK / NOIR	8	100	5.000	5,47
TBB8	ø8 (9x43,5)	BLANCO / WHITE / BLANC	8	100	5.000	5,47
TBG8	ø8 (9x43,5)	GRIS / GREY / GRIS	8	100	5.000	6,00

\* LOS COLORES IMPRESOS AQUÍ SON APROXIMADOS, PARA SOLICITAR MUESTRAS CONTACTE CON NOSOTROS. / \* PRINTED COLORS HERE ARE APPROXIMATE, TO REQUEST SAMPLES CONTACT US. / \* LES COULEURS IMPRIMÉES ICI SONT APPROXIMATIVES, POUR COMMANDER DES ÉCHANTILLONS CONTACTEZ-NOUS.

**BRIDAS DE NYLON POLYAMIDA DE COLOR**

COLOURED NYLON CABLE TIES  
COLLIERS DE SERRAGE COULEURS  
FARBIGE KABELBINDER



CÓDIGO CODE CODE	MEDIDA SIZE MESURE m.m.	*COLOR *COLOR *COULEUR	EMBALAJE QUANTITY EMBALLAGE		PRECIO TARIFA PRICE LIST PRIX TARIFS PREIS TARIF €/100 u.
BZ025098	2,5x98	AZUL BLUE BLEU 5010	100	5.000	1,30
BZ036140	3,6x140		100	5.000	3,33
BZ036200	3,6x200		100	5.000	5,14
BZ048200	4,8x200		100	5.000	6,00
BZ048290	4,8x290		100	5.000	9,33
BR025098	2,5x98	ROJO RED ROUGE 3000	100	5.000	1,30
BR036140	3,6x140		100	5.000	3,33
BR036200	3,6x200		100	5.000	5,14
BR048200	4,8x200		100	5.000	6,00
BR048290	4,8x290		100	5.000	9,33
BV025098	2,5x98	VERDE GREEN VERT 6032	100	5.000	1,30
BV036140	3,6x140		100	5.000	3,33
BV036200	3,6x200		100	5.000	5,14
BV048200	4,8x200		100	5.000	6,00
BV048290	4,8x290		100	5.000	9,33
BA025098	2,5x98	AMARILLO YELLOW JAUNE 1021	100	5.000	1,30
BA036140	3,6x140		100	5.000	3,33
BA036200	3,6x200		100	5.000	5,14
BA048200	4,8x200		100	5.000	6,00
BA048290	4,8x290		100	5.000	9,33
BG048200	4,8x200	GRIS / GREY /	100	10.000	6,00
BG048290	4,8x290	GRIS - 7035	100	10.000	9,33

**TENSOR DE BRIDAS**

COLLAR FASTENING METAL PLIER  
TENSEUR DE COLLIER DE SERRAGE  
KABELSCHELLENZANGE AUS METAL



CÓDIGO CODE CODE	EMBALAJE QUANTITY EMBALLAGE	PRECIO TARIFA PRICE LIST PRIX TARIFS PREIS TARIF €/u.	PRECIO TARIFA PRICE LIST PRIX TARIFS PREIS TARIF €/100 u.
TENSORE	1	43,31	4.330,73

**BASE ADHESIVA PARA BRIDAS DE NYLON**

NYLON SQUARE BASE WITH DUSL-ADHESIVE  
EMBASE CARRÉES EN NYLON AVEC BI-ADHÉSIF  
MONTAGESOCKEL VIERECKIG AUS NYLON GERICHTET MIT KLEBESTREIFEN



CÓDIGO CODE CODE	MEDIDA SIZE MESURE m.m.	*COLOR *COLOR *COULEUR	ANCHO BRIDA TIE WIDTH LARGEUR COLLIER m.m.	EMBALAJE QUANTITY EMBALLAGE		PRECIO TARIFA PRICE LIST PRIX TARIFS PREIS TARIF €/100 u.
BASEADB19	19x19	BLANCO / WHITE / BLANC	4	100	3.000	14,47
BASEADN19	19x19	NEGRO / BLACK / NOIR	4	100	3.000	14,47
BASEADB27	27x27	BLANCO / WHITE / BLANC	4,8	100	6.000	20,00
BASEADN27	27x27	NEGRO / BLACK / NOIR	4,8	100	6.000	20,00

\* LOS COLORES IMPRESOS AQUÍ SON APROXIMADOS, PARA SOLICITAR MUESTRAS CONTACTE CON NOSOTROS. / \* PRINTED COLORS HERE ARE APPROXIMATE, TO REQUEST SAMPLES CONTACT US. / \* LES COULEURS IMPRIMÉES ICI SONT APPROXIMATIVES, POUR COMMANDER DES ÉCHANTILLONS CONTACTEZ-NOUS.

## BRIDAS DE NYLON PARA TUBO

NYLON PIPE FLANGE  
COLLIERS DU TUBE EN NYLON  
FIXBOLT HÜLSENANKER



CÓDIGO CODE CODE	DESCRIPCIÓN DESCRIPTION DESCRIPTION	MEDIDA SIZE MESURE	TUBO PIPE TUBE	EMBALAJE QUANTITY EMBALLAGE	PRECIO TARIFA PRICE LIST PRIX TARIFS PREIS TARIF €/100 U.
BT	BRIDA NYLON PARA TUBO	7x165	16 - 32	100	26,13
TBR	TACO BRIDA PARA TUBO	M 7 - Ø 8	-	100	11,80



INSTALACIÓN  
INSTALLATION  
INSTALLATION

**PASO 1:**  
INTRODUCIR A GOLPE  
EL TACO BRIDA DE-  
JANDO LA ROSCA  
SUPERIOR VISIBLE.

**STEP 1:**  
PLUG-IN INSTALLA-  
TION LEAVING THE  
TOP THREAD VISI-  
BLE.

**ÉTAPE 1:**  
ENTREZ UN COUP  
LE TACET DE COLLIER  
LAISSANT LE FIL SU-  
PÉRIEUR VISIBLE.

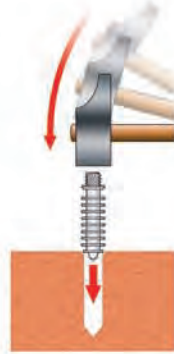

**PASO 2:**  
ROSCAR LA BRIDA  
PARA TUBO EN EL  
TACO HASTA QUEDAR  
BIEN SUJETA.

**STEP 2:**  
SCREW THE PIPE  
FLANGE ON THE  
STUD TO BE SECURE.

**ÉTAPE 2:**  
VISSER LE COLLIER  
SUR LE TACET POUR  
ÊTRE SÛR.

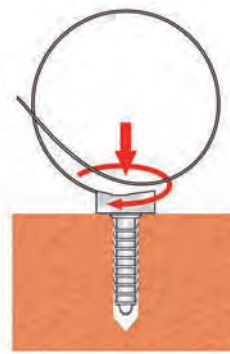

**PASO 3:**  
COLOCAR EL TUBO  
AJUSTANDO LA  
BRIDA Y CORTANDO  
LA PARTE RESTANTE.

**STEP 3:**  
PLACE THE TUBE AD-  
JUSTING THE TIE  
AND CUTTING THE  
REST.

**ÉTAPE 3:**  
PLACER LE TUBE  
AJUSTANT LE CO-  
LLIER ET COUPER LE  
RESTE.

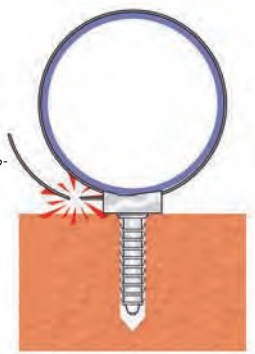

## BRIDAS DE SEGURIDAD

NYLON TAMPER EVIDENT SEALS  
SCÉLLES DE SECURITÉ EN NYLON  
SICHERUNGSPLOMBE AUS NYLON

NUEVO / NEW / NEUF / NEU



CÓDIGO CODE CODE	MODELO MODEL MODÈLE	*COLOR *COLOR *COULEUR	MEDIDA SIZE MESURE	EMBALAJE QUANTITY EMBALLAGE	PRECIO TARIFA PRICE LIST PRIX TARIFS PREIS TARIF €/100 U.
BS	NEUTRA CODIFICADA	AZUL / BLUE / BLEU	6,6x336	300	30,83
BSP	PERSONALIZADA	AZUL / BLUE / BLEU	6,6x336	300	CONSULTAR

PARA LOS DEMÁS COLORES DISPONIBLES (ROJO-RAL 3000, AMARILLO-RAL 1021, VERDE-RAL 6024) Y PARA MARCADO POR IMPRESIÓN TÉRMICA, CON OTROS COLORES DIFERENTES DEL NEGRO, SOLICITE UNA OFERTA A NUESTRO DEPARTAMENTO COMERCIAL.  
FOR OTHER AVAILABLE COLOURS (RED-RAL 3000, YELLOW-RAL 1021, GREEN-RAL 6024). FOR THE THERMIC TRANSFER PRINTS GIVEN BY DIFFERENT COLOURS THAN BLACK, PLEASE ASK FOR QUOTATION AT OUR SALES OFFICE.  
POUR LES AUTRES COULEURS DISPONIBLES (ROUGE-RAL 3000, JAUNE RAL 1021, VERT-RAL 6024). POUR LES IMPRESSIONS, RÉALISÉES PAR TRANSFERT THERMIQUE, AVEC COULEURS DIFFÉRENTS DU NOIR, DEMANDER LES PRIX À NOTRE BUREAU COMMERCIAL.

MÉTODO DE SEPARACIÓN DEL MÓDULO DE 5 UNIDADES:  
SE DEBE ASIR EL PRECINTO POR LA PARTE MOLETEADA Y TIRAR HACIA AFUERA.  
MÉTODO DE APERTURA DEL PRECINTO DESPUÉS DE LA APLICACIÓN:  
DESGARRE LA LENGÜETA HACIA ARRIBA, RETENIENDO LA ETIQUETA DEL PRECINTO CON LA CARA, DONDE APARECE LA PARTE SALIENTE, DIRIGIDA HACIA ARRIBA.

PARTING FROM THE 5 PIECES MODULE:  
THE SEAL IS GRIPPED ON THE KNURLING SIDE AND IT IS PULLED OUTWARDLY.  
SEAL OPENING AFTER THE INSTALLATION:  
TEAR THE TONGUE OFF UPWARDS KEEPING THE LABEL OF THE SEAL UPWARDS WHERE THE PROMINENT SIDE APPEARS.

MODALITÉS DE SÉPARATION DU MODULE DE 5 PIÈCES:  
PRENDRE LE SCELLÉ PAR LA PARTIE MOLETÉE ET TIRER VERS L'EXTÉRIEUR.  
MODALITÉS D'OUVERTURE DU SCELLÉ APRÈS APPLICATION:  
ARRACHER LA LANGUETTE VERS LE HAUT EN GARDANT TOURNÉE VERS LE HAUT LA FACE DE L'ÉTIQUETTE DU SCELLÉ SUR LAQUELLE SE TROUVE LA PARTIE EN SAILLIE.



BRIDA NEUTRA CODIFICADA

BRIDA PERSONALIZADA

## TACO NYLON VZ

VZ NYLON PLUG  
CHEVILLE NYLON VZ  
NYLONDÜBEL VZ

NUEVO / NEW / NEUF / NEU



CÓDIGO CODE CODE	MEDIDA SIZE MESURE	BROCA DRILL FORET	PROF. MÍNIMA T. MIN. HOLE DEPTH PROF. MIN. TROU	TORNILLO SCREW VIS	EMBALAJE QUANTITY EMBALLAGE	PRECIO TARIFA PRICE LIST PRIX TARIFS PREIS TARIF €/100 U.
VZ0632	6x32	6	50	4,5x45	100	3,03
VZ0645	6x45	6	60	4,5x55	100	4,40
VZ0842	8x42	8	60	5x50	100	5,12
VZ0852	8x52	8	70	5x60	100	8,07

**TACO NYLON GTX**

GTX NYLON PLUG  
CHEVILLE NYLON GTX  
NYLONDÜBEL GTX



CÓDIGO CODE CODE	MEDIDA SIZE MESURE	BROCA DRILL FORET	PROF. MÍNIMA T. MIN. HOLE DEPTH PROF. MIN. TROU	Ø TORNILLO Ø SCREW Ø VIS	EMBALAJE QUANTITY EMBALLAGE		PRECIO TARIFA PRICE LIST PRIX TARIFS PREIS TARIF €/100 U.
	m.m.	m.m.	m.m.	m.m.			
GTX05	5x25	5	35	3-4	200	12.000	3,20
GTX06	6x30	6	40	4-5	100	6.000	3,21
GTX08	8x40	8	50	5-6	100	3.000	5,27
GTX10	10x50	10	70	6-8	50	1.500	9,50
GTX12	12x60	12	80	8-10	25	750	19,47
GTX14	14x70	14	90	10-12	20	600	23,33

**TACO NYLON**

NYLON PLUG  
CHEVILLE NYLON  
NYLONDÜBEL

**\*HASTA AGOTAR EXISTENCIAS**



CÓDIGO CODE CODE	MEDIDA SIZE MESURE	--- GRANEL / BULK / MASSE ---		Ø TORNILLO Ø SCREW Ø VIS	EMBALAJE QUANTITY EMBALLAGE		PRECIO TARIFA PRICE LIST PRIX TARIFS PREIS TARIF €/100 U.
		EMBALAJE QUANTITY EMBALLAGE	PRECIO TARIFA PRICE LIST PRIX TARIFS PREIS TARIF €/100 U.				
	m.m.			m.m.			
TN04	4x20	100.000	1,44	2-3	100	4.000	1,99
TN05	5x25	60.000	1,11	3,5-4	100	12.000	1,35
TN06	6x30	38.000	1,25	4-5	100	8.000	1,47
TN07	7x30	30.000	2,85	4,5-5	100	4.000	3,17
TN08	8x40	17.000	2,78	4,5-6	100	4.000	2,89
TN10	10x50	8.000	4,60	6-8	50	2.000	5,07
TN12	12x60	5.000	8,17	8-10	25	1.000	9,30
TN14	14x75	4.000	15,83	10-12	20	800	16,63
TN14100	14x100	1.200	22,17	10-12	50	300	23,33
<b>TN16*</b>	16x80	2.000	36,67	12-14	10	350	41,67

**TACO NYLON CON COLLARÍN**

NYLON PLUG WITH COLLARD  
CHEVILLE NYLON AVEC COLLERETE  
NYLONDÜBEL MIT SAUM

**\*HASTA AGOTAR EXISTENCIAS**



CÓDIGO CODE CODE	MEDIDA SIZE MESURE	--- GRANEL / BULK / MASSE ---		Ø TORNILLO Ø SCREW Ø VIS	EMBALAJE QUANTITY EMBALLAGE		PRECIO TARIFA PRICE LIST PRIX TARIFS PREIS TARIF €/100 U.
		EMBALAJE QUANTITY EMBALLAGE	PRECIO TARIFA PRICE LIST PRIX TARIFS PREIS TARIF €/100 U.				
	m.m.			m.m.			
TNC05	5x25	60.000	1,36	3,5-4	100	12.000	1,43
TNC06	6x30	38.000	1,52	4-5	100	8.000	1,60
TNC08	8x40	17.000	2,93	4,5-6	100	4.000	3,08
TNC10	10x50	8.000	5,34	6-8	50	2.000	5,62
<b>TNC12*</b>	12x60	5.000	10,57	8-10	25	1.000	10,07

**TACO NYLON UNIVERSAL**

UNIVERSAL NYLON PLUG  
CHEVILLE NYLON UNIVERSELLE  
NYLONDÜBEL UNIVERSAL



CÓDIGO CODE CODE	MEDIDA SIZE MESURE	Ø TORNILLO Ø SCREW Ø VIS	EMBALAJE QUANTITY EMBALLAGE		PRECIO TARIFA PRICE LIST PRIX TARIFS PREIS TARIF €/100 U.
	m.m.	m.m.			
TNU06	6x38	4-5	300	3.600	2,87
TNU08	8x42	5-6	100	1.200	4,80
TNU10	10x61	6-8	100	1.200	7,53
TNU12	12x71	8-10	50	600	11,00



## TACO CLAVO CABEZA PLANA

NYLON FAST ANCHOR WITH FLAT COLLAR  
CHEVILLE PRÉMONTE CYLINDRIQUE À FRAPPER  
NYLONDÜBEL MIT ZYLINDERSAUM, MIT VERZINKTER SENKKOPF-NAGELSCHRAUBE



CÓDIGO CODE CODE	MEDIDA SIZE MESURE	EMBALAJE QUANTITY EMBALLAGE		PRECIO TARIFA PRICE LIST PRIX TARIFS PREIS TARIF €/100 U.
	m.m.			
TC05025	5x25	100	1.200	5,00
TC05030	5x30	100	1.200	5,67
TC05045	5x45	100	1.200	6,05
TC06035	6x35	100	1.200	6,77
TC06040	6x40	100	1.200	6,87
TC06060	6x60	100	1.200	8,55
TC06070	6x70	100	1.200	11,53
TC08060	8x60	100	600	13,50
TC08080	8x80	100	600	17,50
TC08100	8x100	100	600	19,53
TC08120	8x120	50	600	24,67
TC08135	8x135	50	600	30,00

## TACO CLAVO CABEZA CÓNICA

NYLON FAST ANCHOR WITH COUNTERSUNK COLLAR  
CHEVILLE PRÉMONTE À FRAPPER  
NYLONDÜBEL MIT SENKSAUM, MIT VERZINKTER SENKKOPF-NAGELSCHRAUBE



CÓDIGO CODE CODE	MEDIDA SIZE MESURE	EMBALAJE QUANTITY EMBALLAGE		PRECIO TARIFA PRICE LIST PRIX TARIFS PREIS TARIF €/100 U.
	m.m.			
TCC05030	5x30	100	1.200	5,67
TCC05045	5x45	100	1.200	6,05
TCC06035	6x35	100	1.200	6,77
TCC06040	6x40	100	1.200	6,87
TCC06060	6x60	100	1.200	8,55
TCC06070	6x70	100	1.200	11,53
TCC08060	8x60	100	600	13,50
TCC08080	8x80	100	600	17,50
TCC08100	8x100	100	600	19,53
TCC08120	8x120	50	600	24,67
TCC08135	8x135	50	600	30,00

## TACO CLAVO + TORNILLO DOBLE ROSCA

NYLON FAST ANCHOR WITH DOUBLE THREAD  
CHEVILLE PRÉMONTE AVEC VIS POUR COLLIER ET CRAMPON  
NYLONDÜBEL MIT ZYLINDERSAUM, MIT VERZINKTER DOPPELGEWINDESCHRAUBE



CÓDIGO CODE CODE	MEDIDA SIZE MESURE	Ø EXTERIOR Ø OUTSIDE Ø EXTÉRIEUR	EMBALAJE QUANTITY EMBALLAGE		PRECIO TARIFA PRICE LIST PRIX TARIFS PREIS TARIF €/100 U.
	m.m.	m.m.			
TCA06035	6x35	6	100	1.200	21,27
TCA08060	8x60	8	50	1.750	34,44

## TACO CLAVO CABEZA CÓNICA INOXIDABLE A-2

NYLON FAST ANCHOR WITH COUNTERSUNK COLLAR AND STAINLESS STEEL AISI 304 SCREW  
CHEVILLE PRÉMONTE À FRAPPER AVEC VIS INOX. A-2  
NYLONDÜBEL MIT SENKSAUM, MIT SENKKOPF-NAGELSCHRAUBE - EDELSTAHL A-2



CÓDIGO CODE CODE	MEDIDA SIZE MESURE	EMBALAJE QUANTITY EMBALLAGE		PRECIO TARIFA PRICE LIST PRIX TARIFS PREIS TARIF €/100 U.
	m.m.			
TCCI05030	5x30	200	2.400	21,07
TCCI06040	6x40	100	1.200	33,13
TCCI06060	6x60	100	1.200	38,33
TCCI08060	8x60	100	600	60,00
TCCI08080	8x80	100	600	70,97
TCCI08100	8x100	100	600	86,33

**TACO NYLON FN**

NYLON ANCHOR WITH STEEL CONICAL EXPANSION NUT  
CHEVILLE NYLON AVEC ÉCROU EN LAITON À EXPANSION  
NYLONDÜBEL MIT SPREIZ-SCHRAUBENMUTTER AUS MESSING



CÓDIGO CODE CODE	MEDIDA SIZE MESURE	BROCA DRILL FORET	EMBALAJE QUANTITY EMBALLAGE		PRECIO TARIFA PRICE LIST PRIX TARIFS PREIS TARIF €/100 U.
FN08	8x80	12	100	600	36,22
FN10	10x80	14	100	600	46,67

**TACO NYLON FN + TORNILLO DIN 933**

NYLON ANCHOR WITH STEEL CONICAL EXPANSION NUT AND HEX. SCREW DIN 933  
CHEVILLE NYLON AVEC ÉCROU EN LAITON À EXPANSION ET VIS TÊTE HEX. DIN 933  
NYLONDÜBEL MIT SPREIZ-SCHRAUBENMUTTER AUS MESSING UND SECHSKANTSCHRAUBE DIN 933



CÓDIGO CODE CODE	MEDIDA SIZE MESURE	BROCA DRILL FORET	EMBALAJE QUANTITY EMBALLAGE		PRECIO TARIFA PRICE LIST PRIX TARIFS PREIS TARIF €/100 U.
FNT08	8x80	12	100	600	64,04
FNT10	10x80	14	100	600	88,30

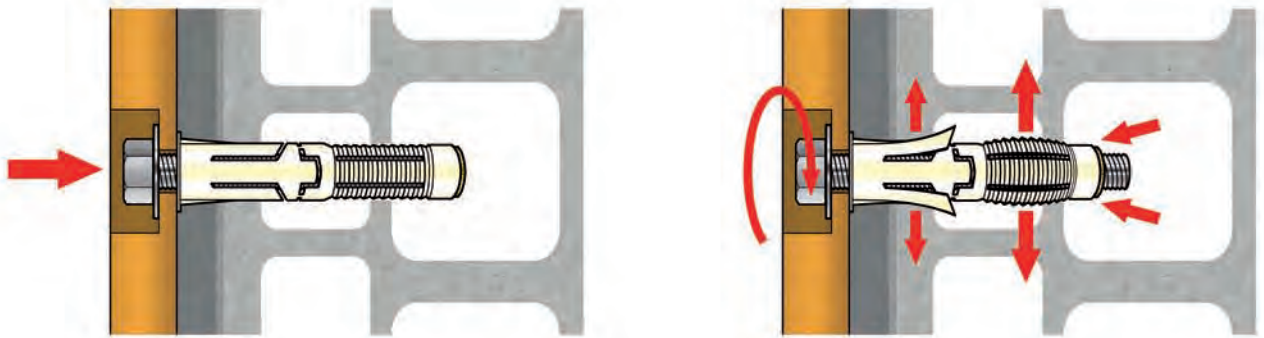

**TACO NYLON FN + TORNILLO INVIOLEABLE 8.8**

NYLON ANCHOR WITH STEEL CONICAL EXPANSION NUT AND SECURITY SCREW 8.8  
CHEVILLE NYLON AVEC ÉCROU EN LAITON À EXPANSION ET VIS INVIOLEABLE 8.8  
NYLONDÜBEL MIT SPREIZ-SCHRAUBENMUTTER AUS MESSING UND SICHERHEITSSCHRAUBE

HASTA AGOTAR EXISTENCIAS



CÓDIGO CODE CODE	MEDIDA SIZE MESURE	BROCA DRILL FORET	PROF. TALADRO HOLE DEPTH PROF. TROU	EMBALAJE QUANTITY EMBALLAGE		PRECIO TARIFA PRICE LIST PRIX TARIFS PREIS TARIF €/100 U.
FN108080	8x80	12	80	100	600	92,07

**TACO NYLON FN + TORNILLO INVIOLEABLE 8.8 TORX**

NYLON ANCHOR WITH STEEL CONICAL EXPANSION NUT AND SECURITY SCREW 8.8  
CHEVILLE NYLON AVEC ÉCROU EN LAITON À EXPANSION ET VIS INVIOLEABLE 8.8  
NYLONDÜBEL MIT SPREIZ-SCHRAUBENMUTTER AUS MESSING UND SICHERHEITSSCHRAUBE



CÓDIGO CODE CODE	MEDIDA SIZE MESURE	BROCA DRILL FORET	PROF. TALADRO HOLE DEPTH PROF. TROU	EMBALAJE QUANTITY EMBALLAGE		PRECIO TARIFA PRICE LIST PRIX TARIFS PREIS TARIF €/100 U.
FNTT08080	8x80	12	80	100	600	116,15

## TACO NYLON VS NUDO

VS MULTI-PURPOSE NYLON ANCHOR  
CHEVILLE UNIVERSELLE RALLONGÉE EN NYLON VS  
UNIVERSAL-LANGSCHAFTDÜBEL AUS NYLON VS

NUEVO / NEW / NEUF / NEU



CÓDIGO CODE CODE	MEDIDA SIZE MESURE	BROCA DRILL FORET	TORNILLO SCREW VIS	EMBALAJE QUANTITY EMBALLAGE		PRECIO TARIFA PRICE LIST PRIX TARIFS PREIS TARIF €/100 U.
	m.m.		m.m.	ØxL (m.m.)		
VS08080	8x80	8	6x85	100	600	21,00
VS08100	8x100	8	6x105	50	300	24,33
VS08120	8x120	8	6x125	50	1.000	26,73
VS10080	10x80	10	7x85	50	1.200	25,40
VS10100	10x100	10	7x105	50	1.200	31,07
VS10120	10x120	10	7x125	50	1.200	36,47
VS10140	10x140	10	7x145	50	1.200	47,60

INSTALACIÓN EN HORMIGÓN  
POR EXPANSIÓN RADIAL /  
INSTALLATION IN CONCRETE  
BY FULLY RADIAL EXPANSION /  
INSTALLATION EN BÉTON  
PAR EXPANSION RADIAL

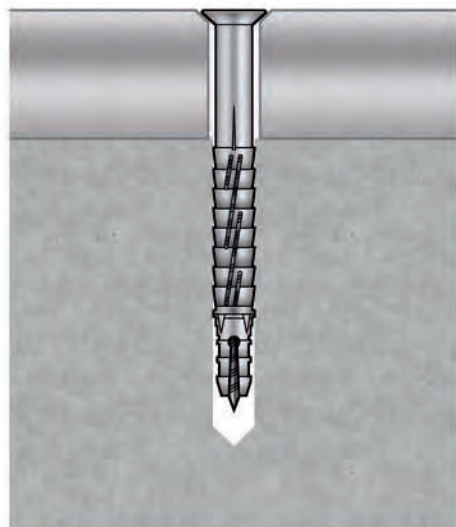

INSTALACIÓN EN LADRILLO HUECO  
POR EXPANSIÓN RADIAL MÚLTIPLE /  
INSTALLATION IN HOLLOW BRICK  
BY MULTIPLE RADIAL EXPANSION /  
INSTALLATION SUR BRIQUE CREUSE  
PAR PLUSIEURS EXPANSION RADIAL

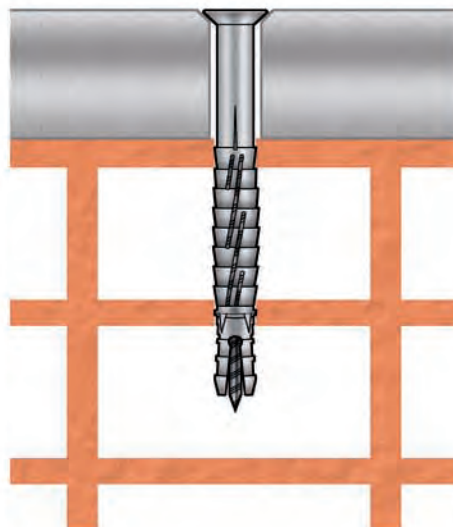

INSTALACIÓN EN HORMIGÓN  
HUECO POR ANUDADO /  
INSTALLATION IN HOLLOW  
CONCRETE BY KNOTTING /  
INSTALLATION SUR BÉTON  
CREUSE PAR NOUJAGE

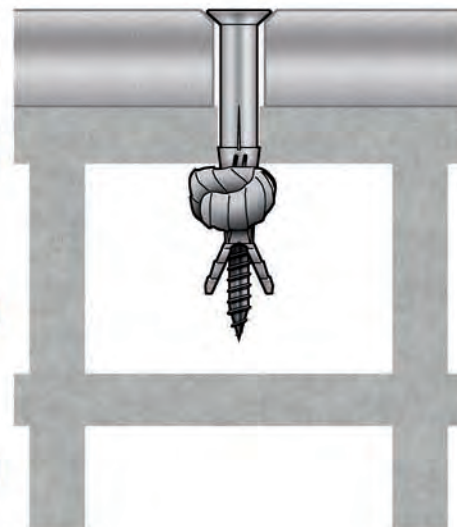

## TACO NYLON VS NUDO + TORNILLO CÓNICO TORX

VS MULTI-PURPOSE NYLON ANCHOR WITH COUNTERSUNK TORX SCREW  
CHEVILLE UNIVERSELLE RALLONGÉE EN NYLON VS AVEC VIS TORX  
UNIVERSAL-LANGSCHAFTDÜBEL AUS NYLON VS MIT SENKKOPF-HOLZSCHRAUBE

NUEVO / NEW / NEUF / NEU



CÓDIGO CODE CODE	MEDIDA SIZE MESURE	BROCA DRILL FORET	TORNILLO SCREW VIS	EMBALAJE QUANTITY EMBALLAGE		PRECIO TARIFA PRICE LIST PRIX TARIFS PREIS TARIF €/100 U.	
	m.m.		m.m.	ØxL (m.m.)			
VSTC08080	8x80	8	6x85	100	1.000	48,33	
VSTC08100	8x100	8	6x105	100	1.000	55,90	
VSTC08120	8x120	8	6x125	100	1.000	69,17	
VSTC08140	8x140	8	6x145	50	500	99,00	
VSTC10080	10x80	Fire Resistance	10	7x85	50	500	63,63
VSTC10100	10x100	Fire Resistance	10	7x105	50	500	79,47
VSTC10120	10x120	Fire Resistance	10	7x125	50	500	95,33
VSTC10140	10x140	Fire Resistance	10	7x145	50	500	108,17
VSTC10160	10x160	Fire Resistance	10	7x175	50	500	131,17
VSTC10200	10x200	Fire Resistance	10	7x205	50	500	200,00
VSTC10230	10x230	Fire Resistance	10	7x235	25	250	266,67

**TACO NYLON VS NUDO + TORNILLO CÓNICO TORX INOXIDABLE A-4**

NUEVO / NEW / NEUF / NEU

VS MULTI-PURPOSE NYLON ANCHOR WITH COUNTERSUNK TORX SCREW ST. STEEL AISI 316  
CHEVILLE UNIVERSELLE RALLONGÉE EN NYLON VS AVEC VIS TORX INOX. A-4  
UNIVERSAL-LANGSCHAFTDÜBEL AUS NYLON VS MIT SENKKOPF-HOLZSCHRAUBE - ED. A-4



CÓDIGO CODE CODE	MEDIDA SIZE MEASURE	BROCA DRILL FORET	TORNILLO SCREW VIS	EMBALAJE QUANTITY EMBALLAGE		PRECIO TARIFA PRICE LIST PRIX TARIFS PREIS TARIF €/100 u.
	m.m.			m.m.	ØxL (m.m.)	
VSTCA408080	8x80	8	6x85	100	1.000	159,07
VSTCA408100	8x100	8	6x105	100	1.000	189,97
VSTCA408120	8x120	8	6x125	100	1.000	221,60
VSTCA408140	8x140	8	6x145	50	500	368,73
VSTCA410080	10x80	10	7x85	50	500	250,00
VSTCA410100	10x100	10	7x105	50	500	268,00
VSTCA410120	10x120	10	7x125	50	500	296,67
VSTCA410140	10x140	10	7x145	50	500	381,70
VSTCA410160	10x160	10	7x175	50	500	487,57
VSTCA410200	10x200	10	7x205	50	500	692,73
VSTCA410230	10x230	10	7x235	25	250	805,17

**TACO NYLON VS NUDO + TORNILLO HEXAGONAL TORX**

NUEVO / NEW / NEUF / NEU

VS MULTI-PURPOSE NYLON ANCHOR WITH HEXAGONAL TORX SCREW  
CHEVILLE UNIVERSELLE RALLONGÉE EN NYLON VS AVEC VIS HEXAGONALE TORX  
UNIVERSAL-LANGSCHAFTDÜBEL AUS NYLON VS MIT SPECIAL-HOLZSCHRAUBE



CÓDIGO CODE CODE	MEDIDA SIZE MEASURE	BROCA DRILL FORET	TORNILLO SCREW VIS	EMBALAJE QUANTITY EMBALLAGE		PRECIO TARIFA PRICE LIST PRIX TARIFS PREIS TARIF €/100 u.
	m.m.			m.m.	ØxL (m.m.)	
VST08080	8x80	8	6x85	100	1.000	56,67
VST08100	8x100	8	6x105	100	1.000	73,00
VST08120	8x120	8	6x125	100	1.000	84,93
VST08140	8x140	8	6x145	50	500	113,00
VST10080	10x80	10	7x85	50	500	86,67
VST10100	10x100	10	7x105	50	500	102,93
VST10120	10x120	10	7x125	50	500	113,33
VST10140	10x140	10	7x145	25	250	131,17
VST10160	10x160	10	7x165	25	250	169,60
VST10200	10x200	10	7x205	25	250	235,47
VST10230	10x230	10	7x235	25	250	390,33

**TACO NYLON VS NUDO + TLLO. HEXAGONAL TORX INOXIDABLE A-4**

NUEVO / NEW / NEUF / NEU

VS MULTI-PURPOSE NYLON ANCHOR WITH SS. AISI 316 HEXAGONAL TORX SCREW  
CHEV. UNIVERSELLE RALLONGÉE EN NYLON VS AVEC VIS HEX. TORX INOX A-4  
UNIVERSAL-LANGSCHAFTDÜBEL AUS NYLON VS MIT SPECIAL-HOLZSCHRAUBE - EDELSTAHL A-4



CÓDIGO CODE CODE	MEDIDA SIZE MEASURE	BROCA DRILL FORET	TORNILLO SCREW VIS	EMBALAJE QUANTITY EMBALLAGE		PRECIO TARIFA PRICE LIST PRIX TARIFS PREIS TARIF €/100 u.
	m.m.			m.m.	ØxL (m.m.)	
VSTA408080	8x80	8	6x85	100	1.000	219,73
VSTA408100	8x100	8	6x105	100	1.000	272,57
VSTA408120	8x120	8	6x125	100	1.000	330,57
VSTA408140	8x140	8	6x145	50	500	467,70
VSTA410080	10x80	10	7x85	50	500	289,70
VSTA410100	10x100	10	7x105	50	500	326,57
VSTA410120	10x120	10	7x125	50	500	368,83
VSTA410140	10x140	10	7x145	25	250	433,77
VSTA410160	10x160	10	7x165	25	250	516,23



## TACO NYLON VS NUDO + TORNILLO INVOLABLE TORX

NUEVO / NEW / NEUF / NEU

VS MULTI-PURPOSE NYLON ANCHOR WITH SECURITY TORX SCREW  
CHEVILLE UNIVERSELLE RALLONGÉE EN NYLON VS AVEC VIS INVOLABLE TORX  
UNIVERSAL-LANGSCHAFTDÜBEL AUS NYLON VS MIT SICHERHEITSSCHRAUBE



CÓDIGO CODE CODE	MEDIDA SIZE MESURE	BROCA DRILL FORET	TORNILLO SCREW VIS	EMBALAJE QUANTITY EMBALLAGE		PRECIO TARIFA PRICE LIST PRIX TARIFS PREIS TARIF €/100 u.
	m.m.			m.m.	ØxL (m.m.)	
VSTI08080	8x80	8	6x85	100	1.000	70,83
VSTI08100	8x100	8	6x105	100	1.000	85,73
VSTI08120	8x120	8	6x125	100	1.000	106,73
VSTI08140	8x140	8	6x145	50	500	147,67
VSTI10080	10x80	Fire Resistance	7x85	50	500	94,90
VSTI10100	10x100	Fire Resistance	7x105	50	500	123,67
VSTI10120	10x120	Fire Resistance	7x125	50	500	145,50
VSTI10140	10x140	Fire Resistance	7x145	25	250	192,23
VSTI10160	10x160	Fire Resistance	7x165	25	250	206,97
VSTI10200	10x200	Fire Resistance	7x205	25	250	358,93

## TACO NYLON LUX-5

LUX-5 NYLON PLUG  
CHEVILLE NYLON LUX-5  
RAHMENDÜBEL AUS NYLON LUX-5

HASTA AGOTAR EXISTENCIAS

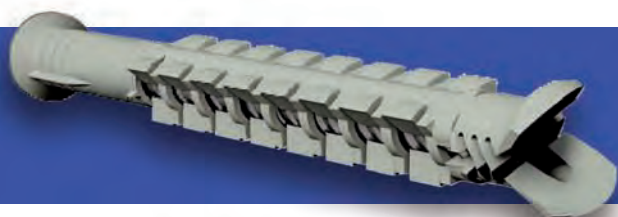

# LUX-5

## TACO LUX-5 + TORNILLO AVELLANADO TORX



CÓDIGO CODE CODE	MEDIDA SIZE MESURE	PROF. TALADRO HOLE DEPTH PROF. TROU	Ø TORNILLO Ø SCREW Ø VIS	LLAVE KEY CLÉ	EMBALAJE QUANTITY EMBALLAGE	PRECIO TARIFA PRICE LIST PRIX TARIFS - INOX A-4 - €/100 u.	PRECIO TARIFA PRICE LIST PRIX TARIFS - ZN - €/100 u.
	m.m.	m.m.	m.m.				
LUX5TCA408080	8x80	100	6	T30	100	158,13	57,33
LUX5TCA408100	8x100	120	6	T30	50	176,93	66,07
LUX5TCA408120	8x120	140	6	T30	50	198,93	71,70
LUX5TCA410085	10x85	100	7	T40	50	248,40	89,40
LUX5TCA410100	10x100	120	7	T40	50	264,90	100,00
LUX5TCA410115	10x115	135	7	T40	50	294,60	107,40
LUX5TCA410135	10x135	160	7	T40	50	367,83	117,53
LUX5TCA410160	10x160	180	7	T40	50	441,60	166,50
LUX5TCA410200	10x200	220	7	T40	50	*627,80	202,13
LUX5TCA410230	10x230	250	7	T40	50	*671,83	266,50

## TACO LUX-5 + TORNILLO 571 COMBINADO TORX T40 + ARANDELA



CÓDIGO CODE CODE	MEDIDA SIZE MESURE	PROF. TALADRO HOLE DEPTH PROF. TROU	Ø TORNILLO Ø SCREW Ø VIS	LLAVE KEY CLÉ	EMBALAJE QUANTITY EMBALLAGE	PRECIO TARIFA PRICE LIST PRIX TARIFS - INOX A-4 - €/100 u.	PRECIO TARIFA PRICE LIST PRIX TARIFS - ZN - €/100 u.
	m.m.	m.m.	m.m.				
LUX5TA410085	10x85	100	7	T40	50	247,83	93,90
LUX5TA410100	10x100	120	7	T40	50	276,50	107,70
LUX5TA410115	10x115	135	7	T40	50	293,97	112,13
LUX5TA410135	10x135	160	7	T40	50	366,93	118,70
LUX5TA410160	10x160	180	7	T40	50	440,50	169,60

**TACO NYLON TRIPLE EXPANSIÓN**

EXTENDED NYLON ANCHOR WITH SIX WINGS  
CHEVILLE NYLON AVEC SIX AILETTES  
NYLON-LANGSCHAFTDÜBELMIT SECHS FLÜGEL



CÓDIGO CODE CODE	MEDIDA SIZE MESURE m.m.	BROCA DRILL FORET m.m.	EMBALAJE QUANTITY EMBALLAGE		PRECIO TARIFA PRICE LIST PRIX TARIFS PREIS TARIF €/100 U.
TNT08080	8x80	8	100	600	13,90
TNT08100	8x100	8	50	300	15,17
TNT08120	8x120	8	50	300	15,67
TNT10080	10x80	10	50	1.000	17,13
TNT10100	10x100	10	50	1.200	20,33
TNT10135	10x140	10	50	1.200	25,00
TNT10160	10x160	10	50	1.200	29,10

**TACO NYLON TRIPLE EXPANSIÓN + TORNILLO DIN 571**

EXTENDED NYLON ANCHOR WITH SIX WINGS AND HEX. WOOD SCREW DIN 571  
CHEVILLE NYLON AVEC SIX AILETTES ET VIS À BOIS TÊTE HEX. DIN 571  
NYLON-LANGSCHAFTDÜBELMIT SECHS FLÜGEL UND SECHSKANT-HOLZSCHRAUBE



CÓDIGO CODE CODE	MEDIDA SIZE MESURE m.m.	TORNILLO SCREW VIS ØxL (m.m.)	BROCA DRILL FORET m.m.	EMBALAJE QUANTITY EMBALLAGE		PRECIO TARIFA PRICE LIST PRIX TARIFS PREIS TARIF €/100 U.
TNTT08080	8x80	5,5	8	100	1.200	33,33
TNTT08100	8x100	5,5	8	50	600	40,00
TNTT08120	8x120	5,5	8	50	600	46,67
TNTT10080	10x80	7	10	50	300	40,00
TNTT10100	10x100	7	10	50	300	52,67
TNTT10140	10x140	7	10	50	300	61,33
TNTT10160	10x160	7	10	50	300	86,67

**TACO NYLON TRIPLE EXPANSIÓN + TORNILLO CÓNICO POZIDRIV**

EXTENDED NYLON ANCHOR WITH SIX WINGS AND COUNTERSUNK WOOD SCREW POZIDRIV  
CHEVILLE NYLON AVEC SIX AILETTES ET VIS CONIQUE POZIDRIV  
NYLON-LANGSCHAFTDÜBELMIT SECHS FLÜGEL UND POZIDRIV-HOLZSCHRAUBE



CÓDIGO CODE CODE	MEDIDA SIZE MESURE m.m.	TORNILLO SCREW VIS ØxL (m.m.)	BROCA DRILL FORET m.m.	EMBALAJE QUANTITY EMBALLAGE		PRECIO TARIFA PRICE LIST PRIX TARIFS PREIS TARIF €/100 U.
TNTTC08080	8x80	5,5	8	50	1.200	22,47
TNTTC08100	8x100	5,5	8	25	600	30,93
TNTTC08120	8x120	5,5	8	25	600	37,13
TNTTC10080	10x80	7	10	25	600	43,30
TNTTC10100	10x100	7	10	25	600	51,70
TNTTC10140	10x140	7	10	25	300	68,90
TNTTC10160	10x160	7	10	25	300	85,06

## TACO PLÁSTICO BLANCO

WHITE WINGS PLASTIC PLUG  
CHEVILLE PLASTIQUE BLANC  
KUNSTSTOFF-DÜBEL WEISS



CÓDIGO CODE CODE	MEDIDA SIZE MESURE m.m.	BROCA DRILL FORET m.m.	EMBALAJE QUANTITY EMBALLAGE		PRECIO TARIFA PRICE LIST PRIX TARIFS PREIS TARIF €/100 U.
TP05	5x20	5	25	1.000	1,46
TP06	6x22	6	25	1.000	1,87
TP07	7x21	7	25	1.000	2,28
TP08	8x25	8	25	1.000	2,63
TP09	9x30	9	25	1.000	3,16
TP10	10x34	10	25	1.000	4,12
TP10L	10x40	10	25	1.000	5,27
TP12	12x42	12	25	1.000	8,26

## TACO AUTOPERFORANTE PARA CARTÓN-YESO

SELF DRILLING ANCHOR FOR PLASTERBOARD  
CHEVILLE AUTOPERCEUSE POUR PLAQUES DE PLÂTRE  
SELBSTBOHRENEN-DÜBEL FÜR GIPSKARTON



CÓDIGO CODE CODE	LARGO LENGTH LONGUEUR m.m.	TORNILLO SCREW VIS ØxL (m.m.)	MATERIAL MATERIAL MATÉRIEL	EMBALAJE QUANTITY EMBALLAGE		PRECIO TARIFA PRICE LIST PRIX TARIFS PREIS TARIF €/100 U.
TPN	37	4,5x35	NYLON	200	2.400	12,83
TPZ	37	4,5x35	ZAMAK	200	2.400	19,70

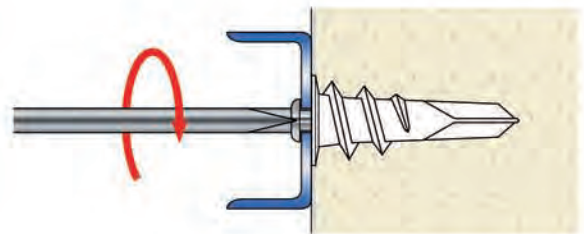
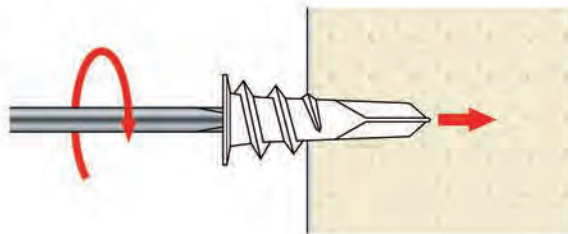
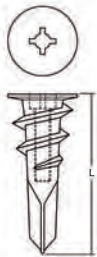

## TACO ALAS PARA CARTÓN-YESO

WINGS ANCHOR FOR PLASTERBOARD  
CHEVILLE NYLON AVEC AILETTES POUR PLAQUES DE PLÂTRE  
NYLONDÜBEL FÜR GIPSKARTON MIT ZWEI FLÜGEL



CÓDIGO CODE CODE	MEDIDA SIZE MESURE m.m.	BROCA DRILL FORET m.m.	TORNILLO SCREW VIS ØxL (m.m.)	MATERIAL MATERIAL MATÉRIEL	EMBALAJE QUANTITY EMBALLAGE		PRECIO TARIFA PRICE LIST PRIX TARIFS PREIS TARIF €/100 U.
TPA0838	8x38	8	3,5x40	NYLON	100	1.200	9,67
TPA0847	8x47	8	3,5x50	NYLON	100	1.200	11,67
TPA1038	10x38	10	4x50	NYLON	100	1.200	10,33
TPA1047	10x47	10	4x60	NYLON	100	600	12,33

**ESPIGA AISLAMIENTO EPA**

EPA ANCHOR FOR INSULATING PANELS FIXING IN CONCRETE  
CHEVILLE POUR PANNEAUX D'ISOLATION SUR BÉTON EPA  
DÜBEL FÜR BEFESTIGUNG VON ISOLIERPLATTE AUF BETON EPA



CÓDIGO CODE CODE	MEDIDA SIZE MESURE	ESPESOR A FIJAR THICKNESS TO FIX ÉPAISSEUR	BROCA DRILL FORET	EMBALAJE QUANTITY EMBALLAGE	PRECIO TARIFA PRICE LIST PRIX TARIFS PREIS TARIF €/100 u.
	m.m.	m.m.	m.m.		
EPA8050	8x50	10/20	8	300	15,90
EPA8070	8x70	30/40	8	300	16,43
EPA8090	8x90	50/60	8	200	19,50
EPA8110	8x110	70/80	8	150	25,90

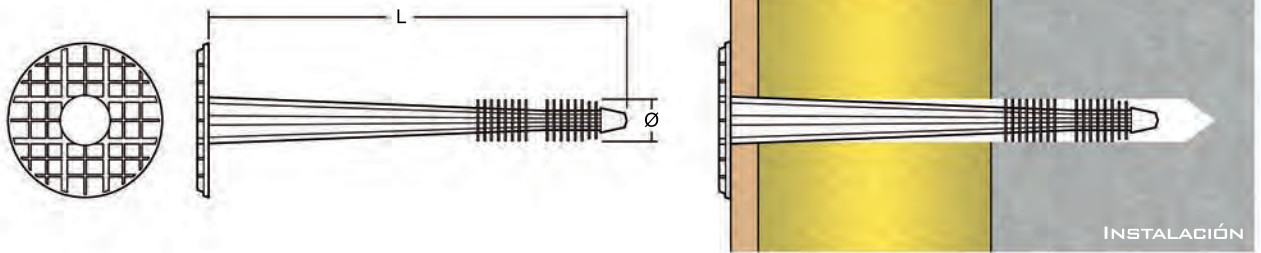

**ESPIGA AISLAMIENTO EPAM**

EPAM ANCHOR WITH NAIL FOR INSULATING PANELS FIXING IN CONCRETE  
CHEVILLE AVEC CLOU POUR PANNEAUX D'ISOLATION SUR BÉTON EPAM  
DÜBEL MIT NAGEL FÜR BEFESTIGUNG VON ISOLIERPLATTE AUF BETON EPAM



CÓDIGO CODE CODE	MEDIDA SIZE MESURE	ESPESOR A FIJAR THICKNESS TO FIX ÉPAISSEUR	BROCA DRILL FORET	EMBALAJE QUANTITY EMBALLAGE	PRECIO TARIFA PRICE LIST PRIX TARIFS PREIS TARIF €/100 u.
	m.m.	m.m.	m.m.		
EPAM10070	10x70	30/40	10	100	18,93
EPAM10090	10x90	50/60	10	50	22,27

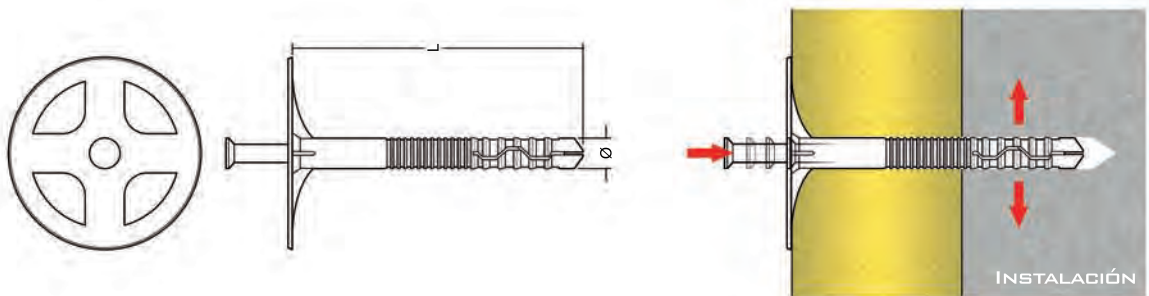

**ARANDELA DE ACERO PARA PANEL AISLANTE**

STEEL LARGE WASHER FOR INSULATED PANELS FIXING  
RONDELLE EN ACIER POUR PANNEAUX D'ISOLATION  
SCHEIBE FÜR BEFESTIGUNG VON ISOLIERPLATTE

NUEVO / NEW / NEUF / NEU



AGUJERO AVELLANADO

CÓDIGO CODE CODE	Ø INTERIOR Ø INSIDE Ø INTÉRIEUR	Ø EXTERIOR Ø OUTSIDE Ø EXTÉRIEUR	GROSOR THICKNESS ÉPAISSEUR	EMBALAJE QUANTITY EMBALLAGE	PRECIO TARIFA PRICE LIST PRIX TARIFS PREIS TARIF €/100 u.
	m.m.	m.m.	m.m.		
LU0106	6,5	70	0,7	100	22,07
LU0109	9	70	0,7	100	22,07



AGUJERO PLANO

CÓDIGO CODE CODE	Ø INTERIOR Ø INSIDE Ø INTÉRIEUR	Ø EXTERIOR Ø OUTSIDE Ø EXTÉRIEUR	GROSOR THICKNESS ÉPAISSEUR	EMBALAJE QUANTITY EMBALLAGE	PRECIO TARIFA PRICE LIST PRIX TARIFS PREIS TARIF €/100 u.
	m.m.	m.m.	m.m.		
LY0106	6,5	70	0,7	100	22,07
LY0109	9	70	0,7	100	22,07



## TACO NYLON PARA MARCOS

NYLON FRAME ANCHOR ASSEMBLED  
CHEVILLE CADRE EN NYLON RALLONGÉE ASSEMBLÉE  
LANGSCHAFTDÜBEL AUS NYLON FÜR FENSTERRAHMEN



CÓDIGO CODE CODE	MEDIDA SIZE MESURE	BROCA DRILL FORET	PROF. TALADRO HOLE DEPTH PROF. TROU	EMBALAJE QUANTITY EMBALLAGE		PRECIO TARIFA PRICE LIST PRIX TARIFS PREIS TARIF €/100 u.
TNM08075	8x75	8	75	50	600	25,27
TNM08100	8x100	8	100	50	600	27,53
TNM08120	8x120	8	120	50	600	31,80
TNM08140	8x140	8	140	50	400	35,90
TNM10075	10x75	10	75	50	400	28,37
TNM10100	10x100	10	100	50	400	32,90
TNM10120	10x120	10	120	50	400	37,30
TNM10140	10x140	10	140	50	400	42,73
TNM10160	10x160	10	160	50	400	51,60

**PASO 1 / STEP 1 / ÉTAPE 1:**  
PERFORACIÓN Y COLOCACIÓN DEL MARCO Y EL TACO.  
DRILL AND INSTALL THE FRAME AND THE ANCHOR.  
PERÇER ET INSTALLER LA TRAME ET LE CHEVILLE.

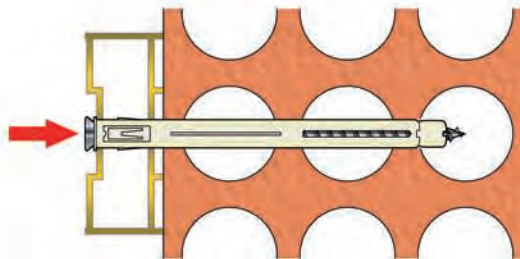

**PASO 2 / STEP 2 / ÉTAPE 2:**  
ATORNILLAR HASTA OBTENER UNA CORRECTA FIJACIÓN.  
SCREWING UNTIL A CORRECT FIXATION.  
VISSEZ JUSQU'À OBTENIR UNE FIXATION CORRECTE.

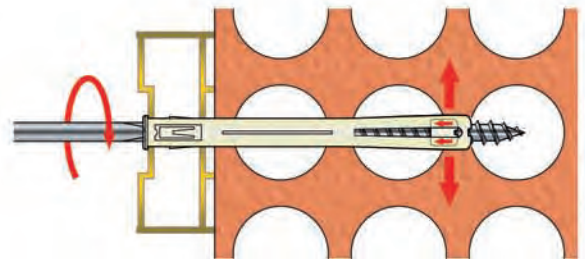

## TACO RASTREL

EXPRESS NAIL FOR LIGHT FASTENINGS  
CHEVILLE ÉLASTIQUE POUR FIXATION DE LITEAUX  
ELASTIC SPRUNGGELLENK FÜR SCHELLEN UND LEICHT FIXIEREN



CÓDIGO CODE CODE	MEDIDA SIZE MESURE	BROCA DRILL FORET	PROF. TALADRO HOLE DEPTH PROF. TROU	EMBALAJE QUANTITY EMBALLAGE		PRECIO TARIFA PRICE LIST PRIX TARIFS PREIS TARIF €/100 u.
RASTRELO6030	6x30	6	30	200	1.600	14,10
RASTRELO6040	6x40	6	40	200	1.600	16,17
RASTRELO6050	6x50	6	50	200	1.600	16,33
RASTRELO6060	6x60	6	60	200	1.600	18,07
RASTRELO6080	6x80	6	80	200	1.600	22,83
RASTRELO8070	8x70	8	70	100	1.600	27,53
RASTRELO8090	8x90	8	90	100	1.600	34,30
RASTRELO8110	8x110	8	110	100	800	41,00
RASTRELO8130	8x130	8	130	100	800	46,30
RASTRELO8150	8x150	8	150	100	800	54,27

**PASO 1 / STEP 1 / ÉTAPE 1:**  
PERFORACIÓN DE LA PIEZA Y EL SOPORTE.  
DRILL THE PIECE AND THE BASE.  
PERÇER LA PIÈCE ET LA BASE.

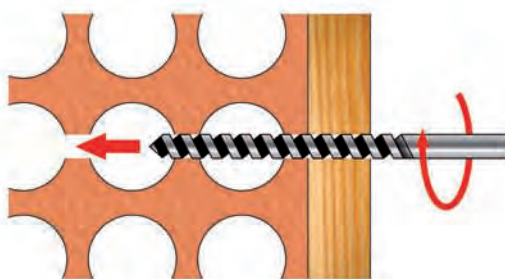

**PASO 2 / STEP 2 / ÉTAPE 2:**  
COLOCACIÓN DEL TACO A GOLPE.  
PLACE THE ANCHOR AND HIT.  
PLACEZ LE CHEVILLE A FRAPPER.

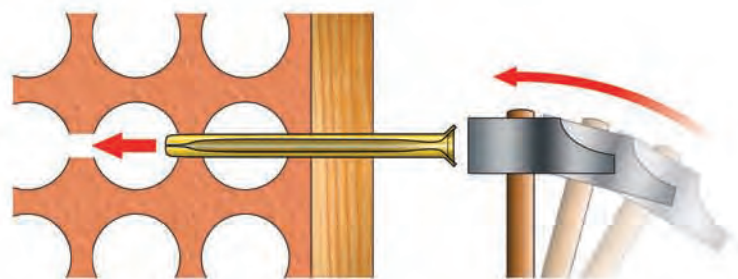

**ANCLAJE EXPANDIBLE PARA CARTÓN-YESO CON TORNILLO COMBI**

NUEVO / NEW / NEUF / NEU

HOLLOW WALL ANCHOR  
CHEVILLE À DOUILLE POUR MURS VIDES  
HÜLSENANKER FÜR LEERE WÄNDE



CÓDIGO CODE CODE	MEDIDA SIZE MESURE	LARGO LENGTH LONGUEUR	Ø BUJE Ø BUSHING Ø BAGUE	BROCA DRILL FORET	ESPESOR A FIJAR THICKNESS TO FIX ÉPAISSEUR	EMBALAJE QUANTITY EMBALLAGE	PRECIO TARIFA PRICE LIST PRIX TARIFS PREIS TARIF €/100 U.
	m.m.	m.m.	m.m.	m.m.	m.m.		
EXPLAT04032	4x32	32	6,5	8	3-12	100	24,97
EXPLAT04038	4x38	38	6,5	8	10-16	100	17,33
EXPLAT04045	4x45	45	6,5	8	16-22	100	18,87
EXPLAT04054	4x54	54	6,5	8	24-30	100	20,60
EXPLAT05037	5x37	37	8,5	10	6-13	100	23,33
EXPLAT05052	5x52	52	8,5	10	10-16	100	27,87
EXPLAT05065	5x65	65	8,5	10	14-32	100	32,20
EXPLAT05080	5x80	80	8,5	10	20-45	50	36,43
EXPLAT06037	6x37	37	10,5	12	6-13	100	30,00
EXPLAT06052	6x52	52	10,5	12	10-16	100	31,77
EXPLAT06065	6x65	65	10,5	12	14-32	100	35,33
EXPLAT06080	6x80	80	10,5	12	20-45	50	40,73

INSTALACIÓN EN PARED HUECA / INSTALLATION IN HOLLOW WALL / INSTALLATION EN MURS VIDES

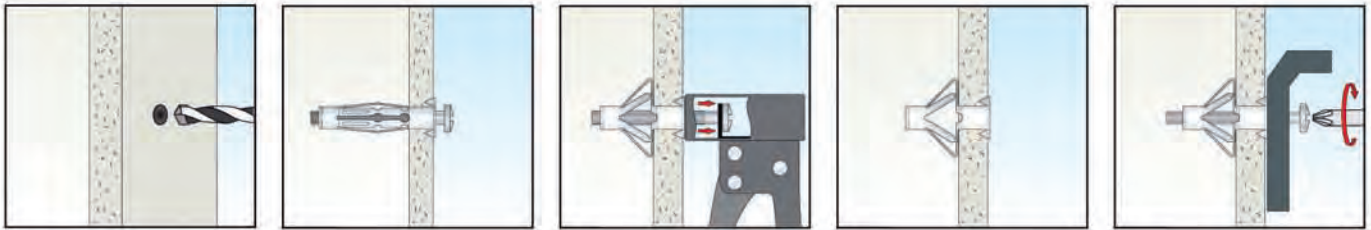

**ALICATES PARA ANCLAJES EN MATERIALES HUECOS**

NUEVO / NEW / NEUF / NEU

TOOLS FOR HOLLOW WALL ANCHORS INSTALLING  
OUTILS POUR LA MISE EN OUVRE DES CHEVILLES POUR MURS VIDES  
WERKZEUGE FÜR DIE MONTAGE VON DÜBEL FÜR LEEREN WÄNDE



CÓDIGO CODE CODE	EMBALAJE QUANTITY EMBALLAGE	PRECIO TARIFA PRICE LIST PRIX TARIFS PREIS TARIF €/u.	PRECIO TARIFA PRICE LIST PRIX TARIFS PREIS TARIF €/100 U.
AP	1	40,00	4.000,00

SECUENCIA DE INSTALACIÓN / SEQUENCE OF INSTALLATION / INSTRUCTIONS DE MISE EN OEUVRE



## ARO ANDAMIO ZAMAK

HASTA AGOTAR EXISTENCIAS

EYEBOLT FOR SCAFFOLDS ASSEMBLED WITH ZAMAK CAPSULE  
 SYSTÈME PUR FIXATION D'ÉCHAFAUDAGE AVEC CHEVILLE ZAMAK  
 RINGSCHRAUBE BEI GERÜST MONTIERT MIT ZAMAK KAPSEL



CÓDIGO CODE CODE	MEDIDA SIZE MESURE	Ø INT. ARO Ø IN. EYE Ø INT. ANNEAU	BROCA DRILL FORET	PROF. TALADRO HOLE DEPTH PROF. TROU	EMBALAJE QUANTITY EMBALLAGE		PRECIO TARIFA PRICE LIST PRIX TARIFS PREIS TARIF €/100 U.
	m.m.	m.m.	m.m.	m.m.			
ZA10160	10x160	19,5	16	100	25	150	266,62

## ARO ANDAMIO CÁPSULA METAL

HASTA AGOTAR EXISTENCIAS

EYEBOLT FOR SCAFFOLDS ASSEMBLED WITH METAL CAPSULE  
 SYSTÈME PUR FIXATION D'ÉCHAFAUDAGE AVEC CHEVILLE ACIER  
 RINGSCHRAUBE BEI GERÜST MONTIERT MIT METAL KAPSEL



CÓDIGO CODE CODE	MEDIDA SIZE MESURE	Ø INT. ARO Ø IN. EYE Ø INT. ANNEAU	BROCA DRILL FORET	PROF. TALADRO HOLE DEPTH PROF. TROU	EMBALAJE QUANTITY EMBALLAGE		PRECIO TARIFA PRICE LIST PRIX TARIFS PREIS TARIF €/100 U.
	m.m.	m.m.	m.m.	m.m.			
MCA10160	10x160	19,5	16	100	25	150	245,75

## ARO ANDAMIO

WELDED EYEBOLT FOR SCAFFOLDS  
 PITON POUR FIXATION D'ÉCHAFAUDAGE  
 GESCHWEISSTE RINGSCHRAUBE FÜR GERÜSTE



CÓDIGO CODE CODE	MEDIDA SIZE MESURE	Ø INT. ARO Ø IN. EYE Ø INT. ANNEAU	EMBALAJE QUANTITY EMBALLAGE		PRECIO TARIFA PRICE LIST PRIX TARIFS PREIS TARIF €/100 U.
	m.m.	m.m.			
CCZ12120	12x120	23	25	100	166,63
CCZ12160	12x160	23	25	100	206,63
CCZ12190	12x190	23	25	100	231,13
CCZ12230	12x230	23	25	100	278,57
CCZ12300	12x300	23	25	100	365,47
CCZ12350	12x350	23	10	60	416,57

## TACO NYLON PARA ANDAMIO

NYLON PLUG FOR SCAFFOLDS EYEBOLT  
 CHEVILLE NYLON POUR FISATION D'ÉCHAFAUDAGE  
 NYLONDÜBEL FÜR GERÜSTE RINGSCHRAUBE

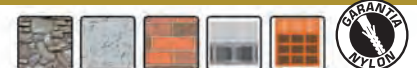

CÓDIGO CODE CODE	MEDIDA SIZE MESURE	BROCA DRILL FORET	PROF. TALADRO HOLE DEPTH PROF. TROU	EMBALAJE QUANTITY EMBALLAGE		PRECIO TARIFA PRICE LIST PRIX TARIFS PREIS TARIF €/100 U.
	m.m.	m.m.	m.m.			
TN14100	14x100	14	105	50	300	23,33

## TAPÓN PARA TACO ARO ANDAMIO

CAP FOR WALLPLUG HOLES  
 BOUCHON POUR FORET  
 KAPPE FÜR WANDSTECKLÖCHERN



CÓDIGO CODE CODE	MEDIDA SIZE MESURE	BROCA DRILL FORET	Ø CABEZA Ø HEAD Ø TÊTE	EMBALAJE QUANTITY EMBALLAGE		PRECIO TARIFA PRICE LIST PRIX TARIFS PREIS TARIF €/100 U.
	m.m.	m.m.	m.m.			
TAA	12x48	14	26	100	600	18,67

**FIJACIONES PARA CAPTADORES TÉRMICOS Y FOTOVOLTAICOS**

ANCHORS FOR THERMAL COLLECTORS AND PHOTOVOLTAICS MODULES  
ANCRAGES POUR CAPTEURS THERMIQUES ET PHANNEAUX PHOTOVOLTAÏQUES  
ANKER FÜR THERMISCHE KOLLEKTOREN UND PHOTOVOLTAÏK MODULES

CAPTADORES TÉRMICOS Y FOTOVOLTAICOS

**LUSAN**  
**SOLAR**

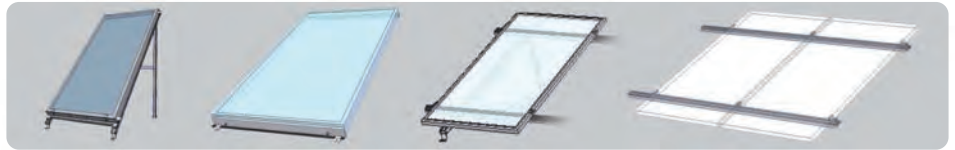

**ANCLAJE PARA TEJA INOX. A2** 10x200 mm



**ANCLAJE HORMIGÓN INOX. A2** 10x150 mm

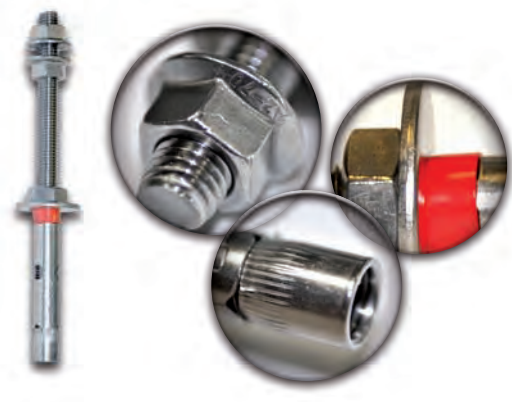

CÓDIGO CODE CODE	MEDIDA SIZE MEASURE	BROCA DRILL FORET	PRECIO TARIFA PRICE LIST PRIX TARIFS PREIS TARIF €/100 U.
CESA2	10x200	10	666,67

CÓDIGO CODE CODE	MEDIDA SIZE MEASURE	BROCA DRILL FORET	PRECIO TARIFA PRICE LIST PRIX TARIFS PREIS TARIF €/100 U.
FES212C	10x150	12	540,00

**SALVATEJAS**

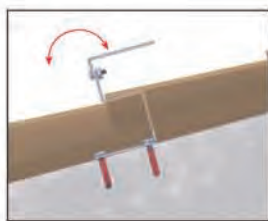
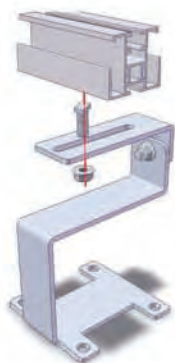

Los salvatejas disponen de un juego de 200 mm para poder salvar la teja sin tener que mecanizarla.

**ESTÁNDAR**

