

TARIFA/CATALOGO N° 33

REMACHES, TUERCAS REMACHABLES,
REMACHADORAS



FABRICANDO REMACHES
DESDE 1971

EDICION 2018

www.remachescya.com



REMACHES CYA, Con más de 40 años en el sector de la fijación, fabrica remaches y piezas especiales estampadas en frío, con un nivel de calidad alto, diferenciando nuestros fabricados por el seguimiento en los procesos de fabricación y los tratamientos específicos que se aplican en dicho proceso, para conseguir un producto que cumpla con los requisitos máximos exigidos.

Así mismo, hemos editado un nuevo catálogo más extenso en oferta – calidad y claridad, unido al suministro de los pedidos en un plazo de 24 / 48 horas.

La atención personalizada a los clientes, colaborando conjuntamente, para recomendar la aplicación adecuada.

NUESTRA HISTORIA

NEMESIO CIORDIA ALVAREZ



Nació en Espronceda 24-6-1925, donde vivió, hasta que se traslado con sus padres y hermanos a Renteria en 1940.

Con estudios básicos (los que había en esa época), comienza a trabajar, como ayudante en una tornillería, destaca rápidamente.

Junto a su gran inteligencia y su capacidad para el trabajo (ilusión, dedicación y un enorme tesón), amplía su formación (después de la jornada de trabajo de 10 horas) se desplazaba diariamente a Éibar a estudiar mecánica, matemáticas y dibujo, se formo un extraordinario mecánico de tornillería, lo disputaban todas las tornillerías de la zona.

Durante su vida profesional le llegaron ofertas de trabajo de empresas importantes, pero su ilusión era tener su propia empresa.

REMACHES CYA, SL

FABRICANTES DESDE 1971

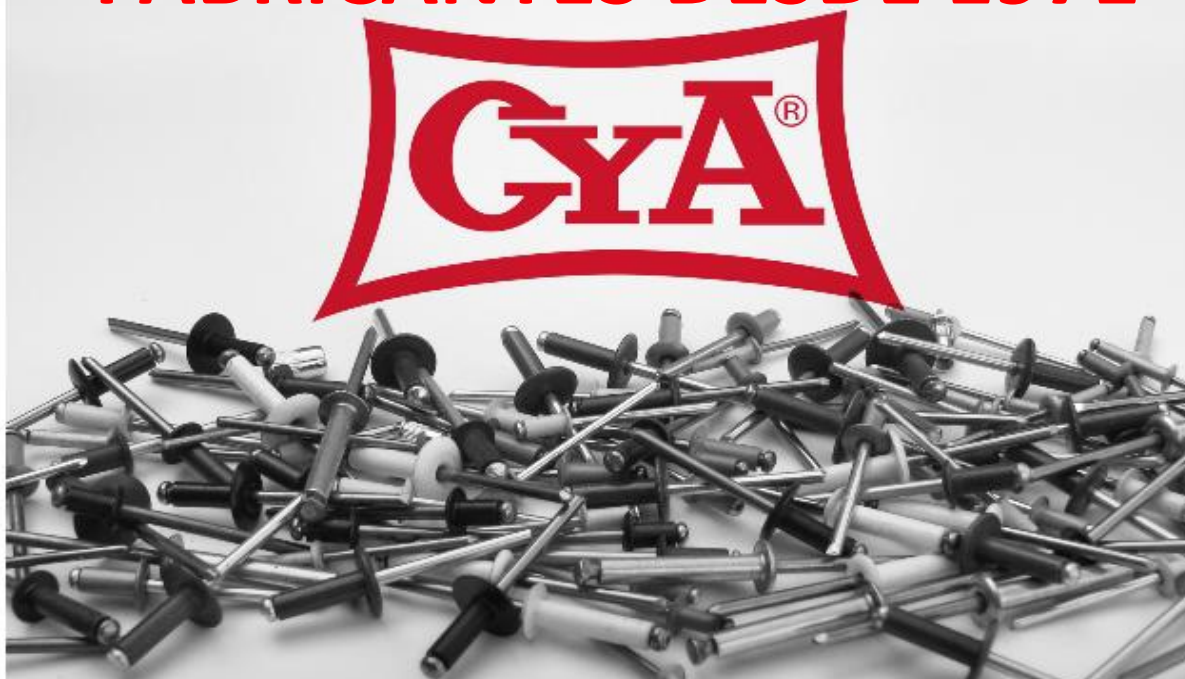

Remaches CYA, S. I.

TELEFONOS: 948.780.420

Ctra. Madrid Km. 6

948.780.976

31591 Corella

948.401.220

Navarra

FAX:

948.780.203

www.remachescya.com

remaches@remachescya.com

CONSULTE DELEGADO DE SU ZONA



CONDICIONES GENERALES VENTA:

La empresa se reserva el derecho de aportar modificaciones sobre los productos en la presente lista de precios, con el fin de mejorar la calidad, sin previo aviso.

- Portes pagados para pedidos superiores a 300€ (antes de IVA).
- Portes pagados para Canarias, Baleares, Ceuta y Melilla pedidos superiores a 1.000€.
- Los pedidos de menor cuantía se enviarán a portes cargados o debidos por su agencia.
- No se admitirán devoluciones pasados 15 días.

No se admitirán devoluciones por motivos no imputables a CYA, para aceptar una devolución tienen que cumplir los siguientes requisitos:

- Piezas de stock, consumo habitual.
- Que la devolución sea notificada y aceptada por CYA
- La devolución será a portes pagados.
- Se realizara el abono del material al valor de venta en su día, menos los gastos ocasionados (re-embalado, re-etiquetado....) Así como el transporte inicial.

- En la lista de precios no está incluido el IVA.
- Cualquier medida podrá ser suministrada a granel o en cajas anónimas o emblistadas a petición del cliente.
- PESOS-CANTIDADES desviación admisible + - 2%.
- Precinto de garantía en el envasado
- Servicio de asistencia – cualquier consulta que tenga, no dude en contactar con nuestro delegado de la zona o con nuestro técnico.

INDICE**REMACHES DATOS MECANICOS 13-16****FAMILIA 1000**

| | |
|---|--------------|
| REMACHE ESTÁNDAR | 17-20 |
| REMACHE LACADO | 21-22 |
| REMACHE CABEZA GRANDE | 23-24 |
| REMACHE CABEZA GRANDE BLANCO | 25 |
| REMACHE CABEZA GRANDE NEGRO | 26 |
| REMACHE CABEZA EXTRA GRANDE | 27 |
| REMACHE CABEZA EXTRA GRANDE BLANCO | 28 |
| REMACHE CABEZA EXTRA GRANDE NEGRO | 29 |
| REMACHE CABEZA AVELLANADA | 31-32 |
| REMACHE ACERO ACERO | 33-34 |
| REMACHE ACERO ALA ANCHA | 35 |
| REMACHE ACERO CAB.AVELLANADA | 36 |
| REMACHE INOX | 37-38 |
| REMACHE INOX ALA ANCHA | 39 |
| REMACHE INOX CAB.AVELLANADA | 40 |
| REMACHE ALUMINIO ALUMINIO | 41 |
| REMACHE ALUMINIO INOX | 42 |
| REMACHE ALUMINIO INOX BLANCO | 43 |
| REMACHE ALUMINIO INOX NEGRO | 44 |
| REMACHE ALUMINIO INOX ALA ANCHA | 45 |
| REMACHE ALUMINIO INOX ALA ANCHA BLANCO | 46 |
| REMACHE ALUMINIO INOX ALA ANCHA NEGRO | 47 |
| REMACHE ALUMINIO INOX ALA SUPER ANCHA | 48 |

| | |
|--|-----------|
| REMACHES ALUMINIO INOX ALA SUPER ANCHA BLANCO | 49 |
| REMACHE ALUMINIO INOX ALA SUPER ANCHA NEGRO | 49 |
| REMACHE ESTANCO | 50 |
| REMACHES ESTANCO CAB.AVELLANADA | 51 |
| REMACHE ESTANCO ALUMINIO ALUMINIO | 52 |
| REMACHE ESTANCO ALUMINIO INOX | 53 |
| REMACHE ESTANCO CAB.AVELLANADA ALUMINIO INOX | 54 |
| REMACHE ESTANCO ACERO | 57 |
| REMACHE ESTANCO INOX | 56 |
| REMACHE ESTANCO COBRE ACERO | 57 |
| REMACHE ESTANCO COBRE INOX | 58 |
| REMACHES COBRE ACERO | 59 |
| REMACHE COBRE BRONCE | 60 |
| REMACHES COBRE INOX | 60 |
| REMACHES RANURADO | 61 |

FAMILIA 2000

| | |
|--|--------------|
| REMACHE FLOR | 62-65 |
| REMACHE FLOR BLANCO | 66 |
| REMACHE FLOR NEGRO | 67 |
| REMACHE FLOR ALA ANCHA | 68 |
| REMACHE FLOR ALA ANCHA BLANCO | 69 |
| REMACHE FLOR ALA ANCHA NEGRO | 70 |
| REMACHE FLOR ALA SUPER ANCHA | 71 |
| REMACHE FLOR ALA SUPER ANCHA BLANCO | 72 |
| REMACHE FLOR ALA SUPER ANCHA NEGRO | 73 |
| REMACHE FLOR ALU/INOX | 74 |

| | |
|--|----|
| REMACHE FLOR BLANCO ALU/INOX | 75 |
| REMACHE FLOR NEGRO ALU/INOX | 76 |
| REMACHE FLOR ALA ANCHA ALU/INOX | 77 |
| REMACHE FLOR ALA ANCHA BLANCO ALU/INOX | 78 |
| REMACHE FLOR ALA ANCHA NEGRO ALU/INOX | 79 |
| REMACHE FLOR ALA SUPER ANCHA ALU/INOX | 80 |
| REMACHE FLOR ALA SUPER ANCHA BLANCO ALU/INOX | 81 |
| REMACHE FLOR ALA SUPER ANCHA NEGRO ALU/INOX | 82 |
| REMACHE FLOR AVELLANADO | 83 |
| REMACHE FLOR AVELLANADO ALU/INOX | 84 |

FAMILIA 3000

| | |
|-----------------------------|-------|
| REMACHE MULTIGRIP | 85-86 |
| REMACHE MULTIGRIP ALA ANCHA | 87 |
| REMACHE MULTIGRIP ALA SUPER | 88 |

FAMILIA 4000

| | |
|------------------------------|----|
| REMACHE TREBOL | 89 |
| REMACHE TREBOL LACADO BLANCO | 89 |
| REMACHE TREBOL LACADO NEGRO | 90 |

FAMILIA 6000

| | |
|----------------------------------|----|
| REMACHE GOLPE ALA SUPER ALU/INOX | 91 |
|----------------------------------|----|

FAMILIA 5000

| | |
|--------------------------------------|----|
| REMACHE ESTRUCTURAL TRIFORME ALU/ALU | 92 |
| REMACHE ESTRUCTURAL MULTIGRIP ACERO | 93 |
| REMACHE ESTRUCTURAL MULTIGRIP INOX | 94 |
| REMACHE ESTRUCTURAL ACERO | 95 |

| | |
|---|--------|
| REMACHE ESTRUCTURAL ACERO CAB.AVELLANADA | 95 |
| REMACHE ESTRUCTURAL ALUMINIO | 96 |
| REMACHE ESTRUCTURAL ALUMINIO CAB.AVELLANADA | 96 |
| REMACHE ESTRUCTURAL INOX | 97 |
| REMACHE ESTRUCTURAL INOX CAB.AVELLANADA | 97 |
| REMACHE ESTRUCTURAL ACERO – 1 | 98 |
| EXPOSITOR | 99-100 |

FAMILIA 0009

| | |
|--|-----|
| BLISTER GRANDE REMACHE ESTÁNDAR | 101 |
| BLISTER GRANDE REMACHE LACADO BLANCO | 102 |
| BLISTER GRANDE REMACHE LACADO NEGRO | 103 |
| BLISTER GRANDE REMACHE CABEZA GRANDE | 104 |
| BLISTER GRANDE REMACHE FLOR | 105 |
| BLISTER GRANDE REMACHE ACERO | 106 |
| BLISTER GRANDE REMACHE INOX | 107 |
| BLISTER GRANDE TUERCA REMACHABLE ACERO CON CABEZA | 108 |
| BLISTER GRANDE TUERCA REMACHABLE ACERO SIN CABEZA | 108 |
| BLISTER GRANDE TUERCA REMACHABLE INOX CON CABEZA | 109 |
| BLISTER GRANDE TUERCA REMACHABLE INOX SIN CABEZA | 109 |
| BLISTER GRANDE TUERCA REMACHABLE ALUMINIO CON CABEZA | 110 |
| BLISTER GRANDE TUERCA REMACHABLE ALUMINIO SIN CABEZA | 110 |

FAMILIA 0008

| | |
|---------------------------------------|-----|
| BLISTER PEQUEÑO REMACHE STANDARD | 111 |
| BLISTER PEQUEÑO REMACHE LACADO BLANCO | 112 |
| BLISTER PEQUEÑO REMACHE LACADO NEGRO | 113 |

| | |
|--|------------|
| BLISTER PEQUEÑO REMACHE CABEZA GRANDE | 114 |
| BLISTER PEQUEÑO REMACHE FLOR | 115 |
| BLISTER PEQUEÑO REMACHE ACERO | 116 |
| BLISTER PEQUEÑO REMACHE INOX | 117 |
| BLISTER PEQUEÑO TUERCA REMACHABLE ACERO CON CABEZA | 118 |
| BLISTER PEQUEÑO TUERCA REMACHABLE ACERO SIN CABEZA | 118 |
| BLISTER PEQUEÑO TUERCA REMACHABLE INOX CON CABEZA | 119 |
| BLISTER PEQUEÑO TUERCA REMACHABLE INOX SIN CABEZA | 119 |
| BLISTER PEQUEÑO TUERCA REMACHABLE ALUMINIO CON CABEZA | 120 |
| BLISTER PEQUEÑO TUERCA REMACHABLE ALUMINIO SIN CABEZA | 120 |

FAMILIA 80000

| | |
|-------------------------------|------------|
| REMACHES MACIZOS | 124 |
| REMACHES SEMITUBULARES | 125 |
| CABECEADORA NEUMATICA | 126 |

FAMILIA 760000

| | |
|--|------------|
| TIPOS DE TUERCAS | 127 |
| TUERCA REMACHABLE ACERO CON CABEZA | 128 |
| TUERCA REMACHABLE ACERO CON CABEZA CIEGA | 129 |
| TUERCA REMACHABLE ACERO CON CABEZA AVELLANADA | 130 |
| TUERCA REMACHABLE ACERO CON CABEZA AVELLANADA CIEGA | 131 |
| TUERCA REMACHABLE ACERO SIN CABEZA | 132 |
| TUERCA REMACHABLE ACERO SEMIHEXAGONAL CON CABEZA | 133 |
| TUERCA REMACHABLE ACERO SEMIHEXAGONAL SIN CABEZA | 134 |
| TUERCA REMACHABLE ACERO HEXAGONAL CON CABEZA | 135 |
| TUERCA REMACHABLE ACERO HEXAGONAL SIN CABEZA | 136 |

| | |
|---|------------|
| TUERCA REMACHABLE INOX CON CABEZA | 137 |
| TUERCA REMACHABLE INOX CON CABEZA AVELLANADA | 138 |
| TUERCA REMACHABLE INOX SIN CABEZA | 139 |
| TUERCA REMACHABLE INOX SEMIHEXAGONAL CON CABEZA | 140 |
| TUERCA REMACHABLE INOX SEMIHEXAGONAL SIN CABEZA | 141 |
| TUERCA REMACHABLE INOX A4 CON CABEZA | 142 |
| TUERCA REMACHABLE INOX A4 CON CABEZA AVELLANADA | 143 |
| TUERCA REMACHABLE ALUMINIO CON CABEZA | 144 |
| TUERCA REMACHABLE ALUMINIO CON CABEZA CIEGA | 145 |
| TUERCA REMACHABLE ALUMINIO CON CABEZA AVELLANADA | 146 |
| TUERCA REMACHABLE ALUMINIO SIN CABEZA | 147 |

FAMILIA 7000

| | |
|-----------------------------------|----------------|
| REMACHADORAS PARA REMACHES | 148-154 |
|-----------------------------------|----------------|

FAMILIA 7100

| | |
|---|----------------|
| REMACHADORA PARA TUERCAS REMACHABLES | 155-160 |
|---|----------------|

TIPOS DE REMACHES

REMACHE STANDARD: AMPLIO RANGO DE ESPESOR A REMACHAR, MONTAJE RAPIDO Y DE GRAN CALIDAD.

REMACHE RANURADO: INDICADO PARA PIEZAS CON TALADROS NO PASANTES, UNION DE GRAN RESISTENCIA, IDEAL PARA FIJAR SUPERFICIES METALICAS A MADERA, LADRILLOS O CEMENTO.

REMACHE FLOR: APTO PARA EL FIJADO DE CUALQUIER OBJETO SOBRE MATERIALES BLANDOS: PLASTICO, PIELES, CARTON, MADERA, LADRILLOS, MATRICULAS... PERMITE SU UTILIZACION EN TALADROS SOBREDIMENSIONADOS, DISTRIBUYE LA CARGA Y LA FUERZA DE APRIETE.

REMACHE MULTIGRIP: MULTI ESPESOR, BUEN RELLENADO DEL TALADRO, PARA APLICACIONES FINAS (POCO ESPESOR) Y PLASTICOS.

REMACHE TREBOL: APLICACIONES DE MATERIALES BLANDOS O DE BAJA RESISTENCIA. (MATRICULAS...)

REMACHE ESTANCO: GARANTIZA UNA FIJACION ESTANCA. LAS UNIONES SON COMPLETAMENTE HERMETICAS A LOS FLUIDOS, EVITANDO FUGAS.

REMACHES ESTRUCTURALES: PARA LAS APLICACIONES MAS EXIGENTES, DONDE SE NECESITA UNA EXCEPCIONAL RESISTENCIA (TRACCION Y CIZALLAMIENTO).



DATOS MECANICOS REMACHES

| TIPO REMACHE | D1. ØREM. | Ø BROCA | D2 Ø ALA | S ALTURA CABEZA | TRACCION | CIZALLAMIENTO |
|-------------------------|--------------|---------|-------------|-----------------------|----------|---------------|
| REM.STANDARD | 2.4 | 2.5 | 5 | 0.5 | 355 | 315 |
| | 2.9 | 3 | 6.5 | 8 | 810 | 620 |
| | 3.2 | 3.25 | 6.5 | 1 | 980 | 760 |
| | 3.9 | 4 | 8.1 | 1.2 | 1600 | 1200 |
| | 4.9 | 5 | 9.5 | 1.4 | 2900 | 2000 |
| | 4.9 TUBO | 5 | 9.3 | 1.5 | 2750 | 2000 |
| | 5.9 | 6 | 12 | 1.5 | 4000 | 3000 |
| | 6.4 | 6.5 | 13 | 1.8 | 4250 | 3150 |
| REM.CAB.GRANDE | 3.9 | 4 | 10 | 1.2 | | |
| | 4.9 | 5 | 14 | 1.5 | 2600 | 1850 |
| | 5.9 | 6 | 15 | 1.8 | | |
| REM.CAB.GRANDE LC. | 3.9 | 4 | 10 | 1.2 | | |
| | 4.9 | 5 | 14 | 1.5 | 2600 | 1850 |
| REM.CAB.EXTRA | 3.2 | 3.25 | 9 | 10 | 980 | 740 |
| | 3.9 | 4 | 12 | 1.2 | 1600 | 1180 |
| | 4.9 | 5 | 16 | 1.5 | 2400 | 1600 |
| REM.CAB.EXTRA LACADO | 3.2 | 3.25 | 9 | 10 | 980 | 740 |
| | 3.9 | 4 | 12 | 1.2 | 1600 | 1180 |
| | 4.9 | 5 | 16 | 1.5 | 2400 | 1600 |
| REM.AVELLANADO | 2.4 | 2.5 | 5 | 0.55 | 355 | 315 |
| | 2.9 | 3 | 5.8 | 1 | 810 | 620 |
| | 3.2 | 3.25 | 6.5 | 1 | 980 | 760 |
| | 3.9 | 4 | 8.1 | 1.2 | 1600 | 1200 |
| | 4.9 | 5 | 9.5 | 1.4 | 2230 | 1690 |
| REM.ACERO | 3 | 3.1 | 6.5 | 0.8 | 1125 | 915 |
| | 3.2 | 3.25 | 6.5 | 0.8 | 1285 | 1060 |
| | 4 | 4.1 | 8 | 1 | 1990 | 1550 |
| | 4.9 | 5 | 9.5 | 1.1 | 2920 | 2300 |
| | 6 | 6.1 | 12 | 1.5 | 5000 | 4000 |
| | 6.4 | 6.5 | 13. | 1.8 | 5400 | 4350 |
| REM.ACERO A/A | 3.2 | 3.25 | 9.5 | 2 | 1285 | 1100 |
| | 4 | 4 | 12 | 1.4 | 2200 | 1700 |
| | 4.9 | 5.1 | 14 | 1.8 | 3100 | 2900 |
| REM.ACERO AVEL. | 3 | 3.1 | 6 | 0.9 | 950 | 1125 |
| | 3.2 | 3.25 | 7.5 | 0.9 | 1990 | 1060 |
| | 4 | 4.1 | 7.5 | 1 | 1990 | 1550 |
| | 4.9 | 5 | 9 | 1.2 | 2920 | 2300 |
| REM.INOX A2 | 3 | 3.1 | 6.5 | 0.8 | 2000 | 1600 |
| | 3.2 | 3.25 | 6.5 | 0.8 | 2500 | 1800 |
| | 4 | 4.1 | 8 | 1 | 3800 | 3100 |
| | 4.9 | 5 | 9.5 | 1.1 | 6000 | 4500 |
| | 6 | 6.1 | 12 | 1.5 | 8550 | 6500 |
| | 6.4 | 6.5 | 13 | 1.8 | 8550 | 6500 |
| REM.INOX A2 A/A | 3.2 | 3.25 | 9.5 | 1.4 | 2360 | 1875 |
| | 4 | 4.1 | 12 | 1.6 | 3650 | 2890 |
| | 4.9 | 5 | 14 | 1.6 | 5335 | 4230 |
| REM.INOX A2 AV. | 3 | 3.1 | 6 | 1.3 | 2000 | 1600 |
| | 3.2 | 3.25 | 6 | 1.3 | 2500 | 1800 |
| | 4 | 4.1 | 7.5 | 1.3 | 3800 | 3100 |
| | 4.9 | 5 | 9 | 1.3 | 6000 | 4500 |



| TIPO REMACHE | D1. ØREM. | Ø BROCA | D2 Ø ALA | S ALTURA CABEZA | TRACCION | CIZALLAMIENTO |
|---------------------------------|--------------|---------|-------------|-----------------------|----------|---------------|
| REM.ALU/ALU | 3.2 | 3.25 | 6.5 | 0.8 | 670 | 535 |
| | 3.9 | 4.1 | 8 | 1 | 1025 | 845 |
| | 4.8 | 4.9 | 9.5 | 1.1 | 1420 | 1150 |
| REM.ALU/INOX | 3 | 3.1 | 6.5 | 0.8 | 870 | 680 |
| | 3.2 | 3.25 | 6.5 | 9.8 | 980 | 760 |
| | 3.9 | 4 | 8 | 1 | 1600 | 1200 |
| | 4.8 | 5 | 9.5 | 1.1 | 2500 | 2000 |
| REM.ALU/INOX LC. | 3.2 | 3.25 | 6.5 | 9.8 | 980 | 760 |
| | 3.9 | 4 | 8 | 1 | 1600 | 1200 |
| | 4.8 | 5 | 9.5 | 1.1 | 2500 | 2000 |
| REM.ALU/INOX A.A | 3.9 | 4.1 | 10 | 1.3 | 1190 | 1740 |
| | 4.9 | 5 | 14 | 1.6 | 1850 | 2600 |
| R.ALU/INOX A.A LC | 3.9 | 4.1 | 10 | 1.3 | 1190 | 1740 |
| | 4.8 | 5 | 14 | 1.6 | 1850 | 2600 |
| REM.ALU/INOX S.A | 4.8 | 5 | 16 | 1.5 | 2500 | 1650 |
| R.ALU/INOX S.A LC | 4.8 | 5 | 16 | 1.5 | 2500 | 1650 |
| REM.ESTANCO ALU/ACE | 3.2 | 3.3 | 6 | 14 | 1250 | 1070 |
| | 3.9 | 4 | 8 | 1.7 | 2240 | 1700 |
| | 4.8 | 4.9 | 9.5 | 2.0 | 3070 | 2230 |
| | 6.4 | 6.5 | 12.7 | 2.5 | 5000 | 3950 |
| REM.ESTANCO C/AV ALU/ACE | 3.2 | 3.3 | 6 | 1.4 | 1245 | 1070 |
| | 4 | 4 | 8 | 1.7 | 2240 | 1710 |
| | 4.8 | 4.9 | 9.5 | 2 | 3070 | 2230 |
| REM.ESTANCO ALU/ALU | 3.2 | 3.3 | 6 | 1.4 | 490 | 450 |
| | 4 | 4.1 | 8 | 1.7 | 820 | 580 |
| | 4.8 | 4.9 | 9.5 | 2 | 1120 | 900 |
| REM.ESTANCO ALU/INOX | 3.2 | 3.3 | 6 | 1.4 | 1250 | 1070 |
| | 4 | 4.1 | 8 | 1.7 | 2240 | 1710 |
| | 4.8 | 4.9 | 9.5 | 2 | 3070 | 2230 |
| REM.ESTANCO ALU/ INOX CAB/AV | 3.2 | 3.3 | 6 | - | 1245 | 1070 |
| | 4 | 4.1 | 7.9 | - | 2240 | 1710 |
| | 4.8 | 4.9 | 9.5 | | 3070 | 2230 |
| REM.ESTANCO ACERO | 3.2 | 3.3 | 6 | 1.4 | 2200 | 1600 |
| | 4 | 4.1 | 8 | 1.4 | 2500 | 2300 |
| | 4.8 | 4.9 | 9.5 | 1.7 | 3800 | 2900 |
| REM.ESTANCO INOX | 3.2 | 3.3 | 6 | 0.9 | 2500 | 2000 |
| | 4 | 4.1 | 8 | 1.3 | 4000 | 3000 |
| | 4.8 | 4.9 | 9.3 | 2.0 | 5500 | 4500 |
| REM.ESTANCO COBRE/ACERO | 3.2 | 3.3 | 6 | 1.4 | 1300 | 850 |
| | 4 | 4.1 | 8 | 1.7 | 2000 | 1350 |
| | 4.8 | 4.9 | 9.5 | 2 | 2800 | 1950 |
| REM.ESTANCO COBRE/INOX | 3.2 | 3.3 | 6 | 1.4 | 1300 | 850 |
| | 4 | 4.1 | 8 | 1.3 | 2000 | 1350 |
| REM.COBRE/ACERO | 3.2 | 3.3 | 6 | 1.4 | 700 | 600 |
| | 4 | 4.1 | 8 | 1.7 | 800 | 700 |
| | 4.8 | 4.9 | 9.5 | 2.0 | 1500 | 1000 |
| REM.COBRE/BRONCE | 3.2 | 3.3 | 6.2 | 0.8 | 2000 | 1500 |
| REM.COBRE/INOX | 4.9 | 5 | 10 | 1.7 | 2960 | 1994 |

| TIPO REMACHE | D1. ØREM. | Ø BROCA | D2 Ø ALA | S ALTURA CABEZA | TRACCION | CIZALLAMIENTO |
|---------------------------------|--------------|---------|-------------|-----------------------|----------|---------------|
| REM.RANURADO | 3.2 | 3.3 | 6 | 1.4 | 930 | 525 |
| | 3.9 | 4 | 8 | 1.7 | 1410 | 885 |
| | 4.8 | 4.9 | 9.5 | 2 | 1575 | 1185 |
| REM.FLOR | 3.2 | 3.3 | 6.0 | 0.8 | 700 | 765 |
| | 3.9 | 4.5 | 8 | 1.2 | 1150 | 1260 |
| | 4.9 | 5.5 | 9 | 1.4 | 2200 | 2400 |
| | 5.9 | 6.5 | 12 | 1.8 | 3000 | 2200 |
| REM.FLOR LC | 3.9 | 4.5 | 8 | 1.2 | 1150 | 1260 |
| | 4.9 | 5.5 | 9 | 1.4 | 2200 | 2400 |
| REM.FLOR A.A | 3.9 | 4.5 | 10 | 1.2 | 1140 | 1280 |
| | 4.9 | 5.5 | 14 | 1.4 | 2450 | 2100 |
| REM.FLOR A.A LC | 3.9 | 4.5 | 10 | 1.2 | 1140 | 1280 |
| | 4.9 | 5.5 | 14 | 1.4 | 2450 | 2100 |
| REM.FLOR S.A | 3.9 | 4.5 | 12 | 1.2 | 1140 | 1280 |
| | 4.9 | 5.5 | 16 | 1.4 | 2450 | 2100 |
| REM.FLOR S.A LC | 3.9 | 4.5 | 12 | 1.2 | 1140 | 1280 |
| | 4.9 | 5.5 | 16 | 1.4 | 2450 | 2100 |
| REM.FLOR ALU/INOX | 3.9 | 4.5 | 8 | 1.2 | 1150 | 1260 |
| | 4.9 | 5.5 | 9 | 1.4 | 2200 | 2400 |
| REM.FLOR ALU/INOX LC. | 3.9 | 4.5 | 8 | 1.2 | 1150 | 1260 |
| | 4.9 | 5.5 | 9 | 1.4 | 2200 | 2400 |
| REM.FLOR ALU/INOX A.A. | 3.9 | 4.5 | 10 | 1.2 | 1140 | 1280 |
| | 4.9 | 5.5 | 14 | 1.4 | 2450 | 2100 |
| REM.FLOR ALU/INOX A.A. LC | 3.9 | 4.5 | 10 | 1.2 | 1140 | 1280 |
| | 4.9 | 5.5 | 14 | 1.4 | 2450 | 2100 |
| REM.FLOR ALU/INOX A.S. | 3.9 | 4.5 | 12 | 1.2 | 1140 | 1280 |
| | 4.9 | 5.5 | 16 | 1.4 | 2450 | 2100 |
| REM.FLOR ALU/INOX A.S. LC | 3.9 | 4.5 | 12 | 1.2 | 1140 | 1280 |
| | 4.9 | 5.5 | 16 | 1.4 | 2450 | 2100 |
| REM.FLOR AVEL. | 3.9 | 4.5 | 8 | 1.2 | 1150 | 1260 |
| | 4.9 | 5.5 | 9 | 1.4 | 2200 | 2400 |
| REM.FLOR AVEL.ALU/INOX | 3.9 | 4.5 | 8 | 1.2 | 1150 | 1260 |
| | 4.9 | 5.5 | 9 | 1.4 | 2200 | 2400 |
| REM.MULTIGRIP | 3 | 3.1 | 6 | 1.4 | 650 | 520 |
| | 3.2 | 3.3 | 6 | 1.4 | 980 | 680 |
| | 4 | 4.1 | 8 | 1.7 | 1600 | 1150 |
| | 4.8 | 4.9 | 9.5 | 2 | 2350 | 1500 |
| REM.MULTIGRIP A/A | 3.2 | 3.3 | 9.5 | 2 | 980 | 680 |
| | 4 | 4.1 | 12 | 2.5 | 1600 | 1150 |
| | 4.8 | 4.9 | 14 | 2.5 | 2350 | 1500 |
| REM.MULTGIRP A/S | 4.8 | 4.9 | 16 | 2.5 | 2350 | 1500 |
| REM.TREBOL | 4 | 4.25 | 8 | 1.4 | 800 | 500 |
| | 4.8 | 5 | 9.6 | 1.6 | 1100 | 800 |
| REM.TREBOL LC | 4 | 4.25 | 8 | 1.4 | 800 | 500 |
| | 4.8 | 5 | 9.6 | 1.6 | 1100 | 800 |
| REM.GOLPE | 4.8 | 4.9 | 14.5 | 2.2 | 2600 | 4500 |
| REM.estruc. TRIFORME ALU/ALU | 5.2 | 5.25 | 11.7 | 2.2 | 2040 | 3290 |

| TIPO REMACHE | D1. ØREM. | Ø BROCA | D2 Ø ALA | S ALTURA CABEZA | TRACCION | CIZALLAMIENTO |
|---------------------------------|--------------|---------|-------------|-----------------------|----------|---------------|
| REM.ESTRUC.MULTIGRIP ACERO | 3.2 | 3.3 | 6.5 | 1.1 | 1300 | 1700 |
| | 4 | 4.1 | 8.1 | 1.2 | 2800 | 3500 |
| | 4.8 | 4.9 | 9.5 | 1.5 | 3800 | 4200 |
| | 6 | 6.1 | 12 | 1.95 | 5400 | 5900 |
| REM.ESTRUC.MULTIGRIP INOX | 3.2 | 3.3 | 6.5 | 1.1 | 1600 | 2000 |
| | 4 | 4.1 | 8 | 1.2 | 4000 | 5200 |
| | 4.8 | 4.9 | 9.5 | 1.5 | 5000 | 5500 |
| REM-ESTRUC.ACERO | 4.8 | 4.9 | 10 | 2.2 | 4400 | 5700 |
| | 6.4 | 6.6 | 13.5 | 3 | 8200 | 10600 |
| REM.ESTRUC.ACERO CAB.AVELLA. | 4.8 | 4.9 | 9 | 2.2 | 4400 | 5700 |
| | 6.4 | 6.6 | 10.5 | 2.4 | 8200 | 10600 |
| REM.ESTRUC.ALU. | 4.8 | 4.9 | 10 | 2.2 | 2000 | 2400 |
| | 6.4 | 6.6 | 13.5 | 3 | 3600 | 5600 |
| REM.ESTRUC.ALU.CAB.AVE | 4.8 | 4.9 | 9 | 2.2 | 2000 | 2400 |
| | 6.4 | 6.6 | 10.5 | 2.4 | 3600 | 5600 |
| REM.ESTRUC.INOX | 4.8 | 4.9 | 10 | 2.2 | 4200 | 5800 |
| | 6.4 | 6.6 | 13.5 | 3 | 8000 | 10500 |
| REM.ESTRUC. INOX CAB.AVEL. | 4.8 | 4.9 | 9 | 2.2 | 4200 | 5800 |
| | 6.4 | 6.6 | 10.5 | 2.4 | 8000 | 10500 |
| REM.ESTRUC.ACE.1 | 4.8 | 5 | 9.8 | 2.2 | 3500 | 3920 |
| | 6.4 | 6.7 | 13.6 | 3.3 | 6470 | 11180 |
| REM.ESTRUC.ACE.1 CAB.AVELLA. | 6.4 | 6.6 | 10 | 2 | 5490 | 10300 |
| REM.ESTRUC.ALU.1 | 6.4 | 6.6 | 13 | 3 | 3500 | 5000 |
| REM.ESTRUC.ALU.1 CAB.AVELLA. | 6.4 | 6.6 | 10 | 2 | 3000 | 4000 |

FAMILIA 1000

REMACHE STANDARD (ALUMINIO – ACERO)

RIVET STANDARD (ALUMINIUM-STEEL)

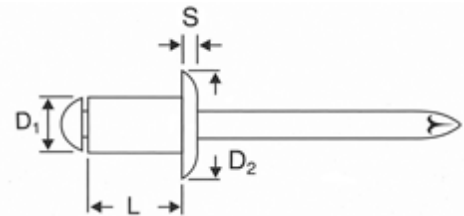

| CODIGO | BROCA Ø2,5 D2:5/S:0.5 REFERENCIA | MEDIDA 2,4 D1 x L | ESPESOR | EMBALAJE | |
|--------|--|-------------------------|---------|----------|----------|
| | | | | INTERIOR | EXTERIOR |
| 20845 | 10002404 | 2,4 x 4 | 0,5-2,0 | 1.000 | 18.000 |
| 20844 | 10002406 | 2,4 x 6 | 2,0-4,0 | 1.000 | 18.000 |
| 20843 | 10002408 | 2,4 x 8 | 4,0-6,0 | 1.000 | 18.000 |
| 20846 | 10002410 | 2,4 x 10 | 6,0-8,0 | 1.000 | 18.000 |

| CODIGO | BROCA Ø3,0 D2:6.5/S:0.8 REFERENCIA | MEDIDA 3 D1 x L | ESPESOR | EMBALAJE | |
|--------|--|-----------------------|-----------|----------|----------|
| | | | | INTERIOR | EXTERIOR |
| 20059 | 10002905 | 2,9 x 5 | 0,5-2,5 | 1.000 | 18.000 |
| 20051 | 10002906 | 2,9 x 6 | 0,5-3,5 | 1.000 | 18.000 |
| 20052 | 10002907 | 2,9 x 7 | 3,5-4,5 | 1.000 | 18.000 |
| 20050 | 10002908 | 2,9 x 8 | 4,5-5,5 | 1.000 | 18.000 |
| 20054 | 10002910 | 2,9 x 10 | 5,5-7,0 | 1.000 | 18.000 |
| 20055 | 10002912 | 2,9 x 12 | 7,0-9,0 | 1.000 | 18.000 |
| 20056 | 10002914 | 2,9 x 14 | 9,0-10,0 | 1.000 | 18.000 |
| 20070 | 10002915 | 2,9 x 15 | 10,0-11,0 | 1.000 | 18.000 |
| 20057 | 10002916 | 2,9 x 16 | 11,0-12,0 | 1.000 | 18.000 |
| 20058 | 10002918 | 2,9 x 18 | 12,0-15,0 | 1.000 | 18.000 |

REMACHE STANDARD (ALUMINIO – ACERO)

RIVET STANDARD (ALUMINIUM-STEEL)

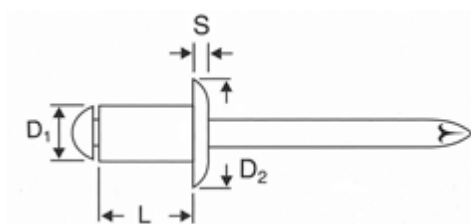

| CODIGO | BROCA Ø3,25 D2:6.5/S:1 REFERENCIA | MEDIDA 3,2 D1 x L | ESPESOR | EMBALAJE | |
|--------|---|-------------------------|-----------|----------|----------|
| | | | | INTERIOR | EXTERIOR |
| 20049 | 10003205 | 3,2 x 5 | 0,5-1,5 | 1.000 | 18.000 |
| 20001 | 10003206 | 3,2 x 6 | 1,5-3,5 | 1.000 | 18.000 |
| 20002 | 10003207 | 3,2 x 7 | 3,5-4,5 | 1.000 | 18.000 |
| 20003 | 10003208 | 3,2 x 8 | 4,5-5,5 | 1.000 | 18.000 |
| 20004 | 10003210 | 3,2 x 10 | 5,5-7,0 | 1.000 | 18.000 |
| 20005 | 10003212 | 3,2 x 12 | 7,0-9,0 | 1.000 | 18.000 |
| 20006 | 10003215 | 3,2 x 15 | 9,0-12,0 | 1.000 | 18.000 |
| 20007 | 10003218 | 3,2 x 18 | 12,0-15,0 | 1.000 | 18.000 |
| 20000 | 10003220 | 3,2 x 20 | 15,0-17,0 | 1.000 | 18.000 |

| CODIGO | BROCA Ø4 D2:8,1/S:1,2 REFERENCIA | MEDIDA 4 D1 x L | ESPESOR | EMBALAJE | |
|--------|--|-----------------------|-----------|----------|----------|
| | | | | INTERIOR | EXTERIOR |
| 20008 | 10003906 | 3,9 x 6 | 1,5-3,0 | 1.000 | 18.000 |
| 20009 | 10003908 | 3,9 x 8 | 3,0-5,0 | 1.000 | 18.000 |
| 20010 | 10003910 | 3,9 x 10 | 5,0-6,5 | 500 | 9.000 |
| 20011 | 10003912 | 3,9 x 12 | 6,5-8,5 | 500 | 9.000 |
| 20071 | 10003914 | 3,9 x 14 | 8,0-8,5 | 500 | 9.000 |
| 20012 | 10003915 | 3,9 x 15 | 8,5-9,0 | 500 | 9.000 |
| 20069 | 10003916 | 3,9 x 16 | 9,0-11,0 | 500 | 9.000 |
| 20013 | 10003918 | 3,9 x 18 | 11,0-14,5 | 500 | 9.000 |
| 20014 | 10003920 | 3,9 x 20 | 14,5-16,5 | 500 | 9.000 |
| 20015 | 10003924 | 3,9 x 24 | 16,5-21,5 | 500 | 9.000 |
| 20016 | 10003927 | 3,9 x 27 | 21,5-23,0 | 500 | 9.000 |
| 20017 | 10003930 | 3,9 x 30 | 23,0-26,0 | 250 | 4.500 |
| 20018 | 10003935 | 3,9 x 35 | 26,0-30,0 | 250 | 4.500 |
| 20019 | 10003940 | 3,9 x 40 | 30,0-35,0 | 250 | 4.500 |

REMACHE STANDARD (ALUMINIO – ACERO)

RIVET STANDARD (ALUMINIUM-STEEL)

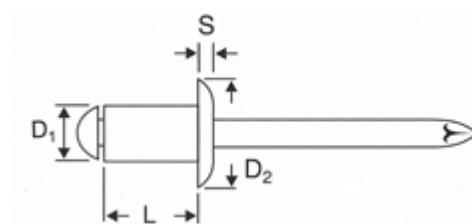

| CODIGO | BROCA Ø5 D2:9,5/S:1,4 REFERENCIA | MEDIDA | ESPESOR | EMBALAJE | EMBALAJE |
|--------|--|-------------|-------------|----------|----------|
| | | 5 D1 x L | | INTERIOR | EXTERIOR |
| 20027 | 10004906 | 4,9 x 6 | 1,5-3,0 | 500 | 9.000 |
| 20028 | 10004908 | 4,9 x 8 | 3,0-4,0 | 500 | 9.000 |
| 20029 | 10004910 | 4,9 x 10 | 4,0-8,0 | 500 | 9.000 |
| 20030 | 10004912 | 4,9 x 12 | 6,0-8,0 | 500 | 9.000 |
| 20031 | 10004914 | 4,9 x 14 | 8,0-10,0 | 500 | 9.000 |
| 20032 | 10004915 | 4,9 x 15 | 10,0-12,0 | 500 | 9.000 |
| 20066 | 10004916 | 4,9 x 16 | 11,0-12,0 | 500 | 9.000 |
| 20033 | 10004918 | 4,9 x 18 | 12,0-14,0 | 500 | 9.000 |
| 20034 | 10004921 | 4,9 x 21 | 14,0-16,0 | 250 | 4.500 |
| 20035 | 10004924 | 4,9 x 24 | 16,0-18,0 | 250 | 4.500 |
| 20036 | 10004927 | 4,9 x 27 | 18,0-21,0 | 250 | 4.500 |
| 20037 | 10004930 | 4,9 x 30 | 21,0-25,0 | 250 | 4.500 |
| 20038 | 10004935 | 4,9 x 35 | 25,0-30,0 | 250 | 4.500 |
| 20039 | 10004940 | 4,9 x 40 | 30,0-35,0 | 200 | 3.600 |
| 20040 | 10004945 | 4,9 x 45 | 35,0-40,0 | 200 | 3.600 |
| 20041 | 10004950 | 4,9 x 50 | 40,0-45,0 | 150 | 2.700 |
| 20042 | 10004955 | 4,9 x 55 | 45,0-50,0 | 150 | 2.700 |
| 20043 | 10004960 | 4,9 x 60 | 50,0-55,0 | 100 | 1.800 |
| 20044 | 10004965 | 4,9 x 65 | 55,0-60,0 | 100 | 1.800 |
| 20045 | 10004970 | 4,9 x 70 | 60,0-65,0 | 100 | 1.800 |
| 20046 | 10004975 | 4,9 x 75 | 65,0-70,0 | 100 | 1.800 |
| 20047 | 10004980 | 4,9 x 80 | 70,0-75,0 | 100 | 1.800 |
| 20048 | 10004990 | 4,9 x 90 | 75,0-85,0 | 50 | 900 |
| 20062 | 100049100 | 4,9 x 100 | 85,0-95,0 | 50 | 900 |
| 20063 | 100049110 | 4,9 x 110 | 95,0-105,0 | 50 | 900 |
| 20064 | 100049120 | 4,9 x 120 | 105,0-115,0 | 50 | 900 |

REMACHE STANDARD (ALUMINIO – ACERO)

RIVET STANDARD (ALUMINIUM-STEEL)

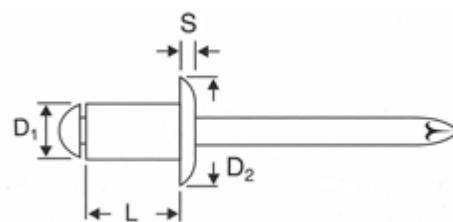

| CODIGO | BROCA Ø6 D2:12/S:1,5 REFERENCIA | MEDIDA 6 D1 x L | ESPESOR | EMBALAJE | |
|--------|---------------------------------------|-----------------------|-------------|----------|----------|
| | | | | INTERIOR | EXTERIOR |
| 20609 | 10005908 | 5,9 x 8 | 1,0-4,0 | 500 | 9.000 |
| 20610 | 10005910 | 5,9 x 10 | 4,0-6,0 | 250 | 4.500 |
| 20611 | 10005912 | 5,9 x 12 | 6,0-8,0 | 250 | 4.500 |
| 20612 | 10005915 | 5,9 x 15 | 8,0-11,0 | 250 | 4.500 |
| 20613 | 10005918 | 5,9 x 18 | 11,0-13,0 | 250 | 4.500 |
| 20614 | 10005921 | 5,9 x 21 | 13,0-15,0 | 250 | 4.500 |
| 20615 | 10005924 | 5,9 x 24 | 15,0-20,0 | 250 | 4.500 |
| 20616 | 10005927 | 5,9 x 27 | 20,0-22,0 | 250 | 4.500 |
| 20617 | 10005930 | 5,9 x 30 | 22,0-24,0 | 200 | 4.500 |
| 20618 | 10005935 | 5,9 x 35 | 24,0-29,0 | 200 | 3.600 |
| 20619 | 10005940 | 5,9 x 40 | 29,0-34,0 | 200 | 3.600 |
| 20620 | 10005945 | 5,9 x 45 | 34,0-39,0 | 100 | 1.800 |
| 20621 | 10005950 | 5,9 x 50 | 40,0-45,0 | 100 | 1.800 |
| 20622 | 10005960 | 5,9 x 60 | 50,0-55,0 | 100 | 1.800 |
| 20623 | 10005970 | 5,9 x 70 | 60,0-65,0 | 100 | 1.800 |
| 20624 | 10005980 | 5,9 x 80 | 70,0-75,0 | 100 | 1.800 |
| 20625 | 10005990 | 5,9 x 90 | 75,0-85,0 | 100 | 1.800 |
| 20626 | 100059100 | 5,9 x 100 | 85,0-95,0 | 100 | 1.800 |
| 20627 | 100059110 | 5,9 x 110 | 95,0-105,0 | 100 | 1.800 |
| 20628 | 100059120 | 5,9 x 120 | 105,0-115,0 | 100 | 1.800 |

| CODIGO | BROCA Ø6,5 D2:13/S:1,5 REFERENCIA | MEDIDA 6,4 D1 x L | ESPESOR | EMBALAJE | |
|--------|---|-------------------------|-----------|----------|----------|
| | | | | INTERIOR | EXTERIOR |
| 20650 | 10006413 | 6,4 x 13 | 2,0-6,0 | 250 | 4.500 |
| 20652 | 10006415 | 6,4 x 15 | 6,0-9,0 | 250 | 4.500 |
| 20651 | 10006418 | 6,4 x 18 | 9,0-12,0 | 250 | 4.500 |
| 20657 | 10006420 | 6,4 x 20 | 12,0-14,0 | 250 | 4.500 |
| 20653 | 10006424 | 6,4 x 24 | 14,0-18,0 | 250 | 4.500 |
| 20654 | 10006430 | 6,4 x 30 | 20,0-24,0 | 200 | 3.600 |
| 20655 | 10006440 | 6,4 x 40 | 25,0-34,0 | 200 | 3.600 |



FABRICACION MAXIMA 120 mm – CONSULTAR

FAMILIA 1001



REMACHE LACADO BLANCO ALU/ACE

RIVET LACQUERED (ALUMINIUM-STEEL)

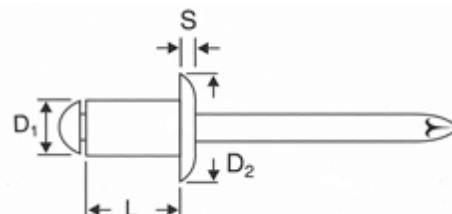

| CODIGO | BROCA Ø3,25 D2:6,5/S:1,0 REFERENCIA | MEDIDA 3,2 D1 x L | ESPESOR | EMBALAJE | |
|--------|---|-------------------------|-----------|----------|----------|
| | | | | INTERIOR | EXTERIOR |
| 40001 | 10013206 | 3,2 x 6 | 1,5-3,5 | 500 | 9.000 |
| 40003 | 10013208 | 3,2 x 8 | 4,5-5,5 | 500 | 9.000 |
| 40004 | 10013210 | 3,2 x 10 | 5,5-7,0 | 500 | 9.000 |
| 40005 | 10013212 | 3,2 x 12 | 7,0-9,0 | 500 | 9.000 |
| 40006 | 10013215 | 3,2 x 15 | 9,0-12,0 | 500 | 9.000 |
| 40007 | 10013218 | 3,2 x 18 | 12,0-15,0 | 500 | 9.000 |

| CODIGO | BROCA Ø4 D2:8,1/S:1,2 REFERENCIA | MEDIDA 4 D1 x L | ESPESOR | EMBALAJE | |
|--------|--|-----------------------|-----------|----------|----------|
| | | | | INTERIOR | EXTERIOR |
| 40008 | 10013906 | 3,9 x 6 | 1,5-3,0 | 500 | 9.000 |
| 40009 | 10013908 | 3,9 x 8 | 3,0-5,0 | 500 | 9.000 |
| 40010 | 10013910 | 3,9 x 10 | 5,0-6,5 | 500 | 9.000 |
| 40011 | 10013912 | 3,9 x 12 | 6,5-8,5 | 500 | 9.000 |
| 40012 | 10013915 | 3,9 x 15 | 8,5-11,0 | 500 | 9.000 |
| 40013 | 10013918 | 3,9 x 18 | 11,0-14,5 | 500 | 9.000 |
| 40014 | 10013920 | 3,9 x 20 | 14,5-16,5 | 500 | 9.000 |
| 40015 | 10013924 | 3,9 x 24 | 16,5-21,5 | 500 | 9.000 |
| 40016 | 10013927 | 3,9 x 27 | 21,5-23,0 | 250 | 9.000 |
| 40017 | 10013930 | 3,9 x 30 | 23,0-25,0 | 250 | 9.000 |

| CODIGO | BROCA Ø5 D2:9,5/S:1,4 REFERENCIA | MEDIDA 5 D1 x L | ESPESOR | EMBALAJE | |
|--------|--|-----------------------|-----------|----------|----------|
| | | | | INTERIOR | EXTERIOR |
| 40028 | 10014908 | 4,9 x 8 | 0,5-4,5 | 500 | 4.500 |
| 40029 | 10014910 | 4,9 x 10 | 4,5-6,0 | 500 | 4.500 |
| 40030 | 10014912 | 4,9 x 12 | 6,0-8,0 | 500 | 4.500 |
| 40032 | 10014915 | 4,9 x 15 | 8,0-11,0 | 500 | 4.500 |
| 40033 | 10014918 | 4,9 x 18 | 11,0-14,0 | 500 | 4.500 |
| 40034 | 10014921 | 4,9 x 21 | 14,0-16,0 | 250 | 4.500 |
| 40035 | 10014924 | 4,9 x 24 | 16,0-18,0 | 250 | 4.500 |
| 40036 | 10014927 | 4,9 x 27 | 18,0-21,0 | 250 | 4.500 |
| 40037 | 10014930 | 4,9 x 30 | 21,0-25,0 | 250 | 4.500 |
| 40038 | 10014935 | 4,9 x 35 | 25,0-30,0 | 200 | 3.600 |
| 40039 | 10014940 | 4,9 x 40 | 30,0-35,0 | 200 | 3.600 |

CONSULTAR: EL COLOR QUE NECESITE – LARGURA HASTA 120mm

FAMILIA 1002



REMACHE LACADO NEGRO ALU/ACE

RIVET LACQUERED (ALUMINIUM-STEEL)

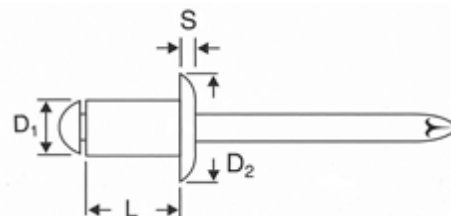

| CODIGO | BROCA Ø3,25 D2:6,5/S:1,0 REFERENCIA | MEDIDA 3,2 D1 x L | ESPESOR | EMBALAJE | |
|--------|---|-------------------------|-----------|----------|----------|
| | | | | INTERIOR | EXTERIOR |
| 40101 | 10023206 | 3,2 x 6 | 1,5-3,5 | 500 | 9.000 |
| 40103 | 10023208 | 3,2 x 8 | 4,5-5,5 | 500 | 9.000 |
| 40104 | 10023210 | 3,2 x 10 | 5,5-7,0 | 500 | 9.000 |
| 40105 | 10023212 | 3,2 x 12 | 7,0-9,0 | 500 | 9.000 |
| 40106 | 10023215 | 3,2 x 15 | 9,0-12,0 | 500 | 9.000 |
| 40107 | 10023218 | 3,2 x 18 | 12,0-15,0 | 500 | 9.000 |

| CODIGO | BROCA Ø4 D2:8,1/S:1,2 REFERENCIA | MEDIDA 4 D1 x L | ESPESOR | EMBALAJE | |
|--------|--|-----------------------|-----------|----------|----------|
| | | | | INTERIOR | EXTERIOR |
| 40108 | 10023906 | 3,9 x 6 | 1,5-3,0 | 500 | 9.000 |
| 40109 | 10023908 | 3,9 x 8 | 3,0-5,0 | 500 | 9.000 |
| 40110 | 10023910 | 3,9 x 10 | 5,0-6,5 | 500 | 9.000 |
| 40111 | 10023912 | 3,9 x 12 | 6,5-8,5 | 500 | 9.000 |
| 40112 | 10023915 | 3,9 x 15 | 8,5-11,0 | 500 | 9.000 |
| 40113 | 10023918 | 3,9 x 18 | 11,0-14,5 | 500 | 9.000 |
| 40114 | 10023920 | 3,9 x 20 | 14,5-16,5 | 500 | 9.000 |
| 40115 | 10023924 | 3,9 x 24 | 16,5-21,5 | 500 | 9.000 |
| 40116 | 10023927 | 3,9 x 27 | 21,5-23,0 | 250 | 9.000 |
| 40117 | 10023930 | 3,9 x 30 | 23,0-25,0 | 250 | 9.000 |

| CODIGO | BROCA Ø5 D2:9,5/S:1,4 REFERENCIA | MEDIDA 5 D1 x L | ESPESOR | EMBALAJE | |
|--------|--|-----------------------|-----------|----------|----------|
| | | | | INTERIOR | EXTERIOR |
| 40128 | 10024908 | 4,9 x 8 | 0,5-4,5 | 500 | 4.500 |
| 40129 | 10024910 | 4,9 x 10 | 4,5-6,0 | 500 | 4.500 |
| 40130 | 10024912 | 4,9 x 12 | 6,0-8,0 | 500 | 4.500 |
| 40132 | 10024915 | 4,9 x 15 | 8,0-11,0 | 500 | 4.500 |
| 40133 | 10024818 | 4,9 x 18 | 11,0-14,0 | 500 | 4.500 |
| 40134 | 10024921 | 4,9 x 21 | 14,0-16,0 | 250 | 4.500 |
| 40135 | 10024924 | 4,9 x 24 | 16,0-18,0 | 250 | 4.500 |
| 40136 | 10024927 | 4,9 x 27 | 18,0-21,0 | 250 | 4.500 |
| 40137 | 10024930 | 4,9 x 30 | 21,0-25,0 | 250 | 4.500 |
| 40138 | 10024935 | 4,9 x 35 | 25,0-30,0 | 200 | 3.600 |
| 40139 | 10024940 | 4,9 x 40 | 30,0-35,0 | 200 | 3.600 |

CONSULTAR: EL COLOR QUE NECESITE – LARGURA HASTA 120mm

FAMILIA 1100

REMACHE CABEZA GRANDE (ALUMINIO – ACERO)

RIVET LARGE HEAD (ALUMINIUM-STEEL)

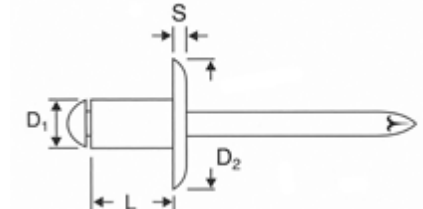

| CODIGO | BROCA Ø4 D2:10/S:1,2 REFERENCIA | MEDIDA 4 D1 x L | ESPESOR | EMBALAJE | |
|--------|---------------------------------------|-----------------------|-----------|----------|----------|
| | | | | INTERIOR | EXTERIOR |
| 20708 | 11003906 | 3,9 x 6 | 1,5-3,0 | 1.000 | 18.000 |
| 20709 | 11003908 | 3,9 x 8 | 3,0-5,0 | 1.000 | 18.000 |
| 20710 | 11003910 | 3,9 x 10 | 5,0-6,5 | 500 | 9.000 |
| 20711 | 11003912 | 3,9 x 12 | 6,5-8,5 | 500 | 9.000 |
| 20712 | 11003915 | 3,9 x 15 | 8,5-11,0 | 500 | 9.000 |
| 20713 | 11003918 | 3,9 x 18 | 11,0-14,5 | 500 | 9.000 |
| 20714 | 11003920 | 3,9 x 20 | 14,5-16,5 | 500 | 9.000 |
| 20715 | 11003924 | 3,9 x 24 | 16,5-21,5 | 500 | 9.000 |

| CODIGO | BROCA Ø5 D2:14/S:1,5 REFERENCIA | MEDIDA 5 D1 x L | ESPESOR | EMBALAJE | |
|--------|---------------------------------------|-----------------------|-----------|----------|----------|
| | | | | INTERIOR | EXTERIOR |
| 20728 | 11004908 | 4,9 x 8 | 0,5-4,5 | 500 | 9.000 |
| 20729 | 11004910 | 4,9 x 10 | 4,5-6,0 | 250 | 4.500 |
| 20730 | 11004912 | 4,9 x 12 | 6,0-8,0 | 250 | 4.500 |
| 20731 | 11004914 | 4,9 x 14 | 8,0-10,0 | 250 | 4.500 |
| 20732 | 11004916 | 4,9 x 16 | 10,0-12,0 | 250 | 4.500 |
| 20733 | 11004918 | 4,9 x 18 | 12,0-14,0 | 250 | 4.500 |
| 20734 | 11004921 | 4,9 x 21 | 14,0-16,0 | 250 | 4.500 |
| 20735 | 11004924 | 4,9 x 24 | 16,0-18,0 | 250 | 4.500 |
| 20736 | 11004927 | 4,9 x 27 | 18,0-21,0 | 250 | 4.500 |
| 20737 | 11004930 | 4,9 x 30 | 21,0-25,0 | 250 | 4.500 |
| 20738 | 11004935 | 4,9 x 35 | 25,0-30,0 | 250 | 4.500 |

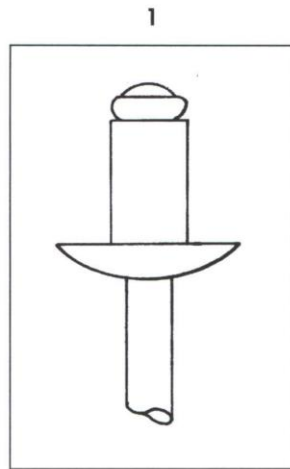

Ø 3,9 cabeza 10 mm.
Ø 4,9 tête 14 mm.

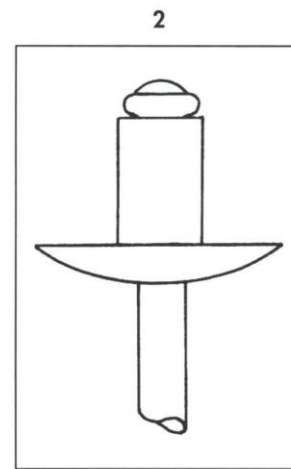

Ø 3,9 cabeza 12 mm.
Ø 4,9 tête 16 mm.

El remache cabeza grande **CYA**,
idóneo para todo tipo de materia-
les metálicos, donde se necesita
una mayor superficie de apoyo,
como carrocerías, etc.

1 = CABEZA GRANDE

2 = CABEZA EXTRA GRANDE

REMACHE CABEZA GRANDE (ALUMINIO – ACERO)

RIVET LARGE HEAD (ALUMINIUM-STEEL)

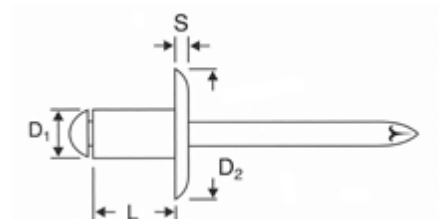

| CODIGO | BROCA Ø6 D2:15/S:1,8 REFERENCIA | MEDIDA 6 D1 x L | ESPESOR | EMBALAJE | |
|--------|---------------------------------------|-----------------------|-----------|----------|----------|
| | | | | INTERIOR | EXTERIOR |
| 20628 | 11005908 | 5,9 x 8 | 1,0-4,0 | 500 | 9.000 |
| 20629 | 11005910 | 5,9 x 10 | 4,0-6,0 | 250 | 4.500 |
| 20630 | 11005912 | 5,9 x 12 | 6,0-8,0 | 250 | 4.500 |
| 20632 | 11005915 | 5,9 x 15 | 8,0-11,0 | 250 | 4.500 |
| 20633 | 11005918 | 5,9 x 18 | 11,0-13,0 | 250 | 4.500 |
| 20634 | 11005921 | 5,9 x 21 | 13,0-15,0 | 250 | 4.500 |
| 20635 | 11005924 | 5,9 x 24 | 15,0-20,0 | 250 | 4.500 |
| 20636 | 11005927 | 5,9 x 27 | 20,0-22,0 | 250 | 4.500 |
| 20637 | 11005930 | 5,9 x 30 | 22,0-24,0 | 200 | 3.600 |
| 20638 | 11005935 | 5,9 x 35 | 24,0-29,0 | 200 | 3.600 |
| 20639 | 11005940 | 5,9 x 40 | 29,0-34,0 | 200 | 3.600 |
| 20640 | 11005945 | 5,9 x 45 | 34,0-39,0 | 100 | 1.800 |



FABRICACION MAXIMA 120 mm - CONSULTAR

FAMILIA 1101



REMACHE CABEZA GRANDE BLANCO ALU/ACE

RIVET LARGE HEAD LACQUERED (ALUMINIUM-STEEL)

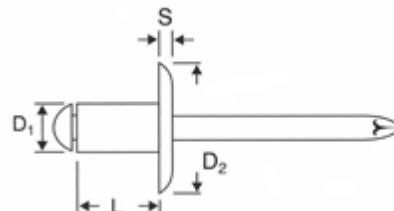

| CODIGO | BROCA Ø4 D2:10/S:1,2 REFERENCIA | MEDIDA 4 D1 x L | ESPESOR | EMBALAJE | |
|--------|---------------------------------------|-----------------------|-----------|----------|----------|
| | | | | INTERIOR | EXTERIOR |
| 42008 | 11013906 | 3,9 x 6 | 1,5-3,0 | 1.000 | 18.000 |
| 42009 | 11013908 | 3,9 x 8 | 3,0-5,0 | 1.000 | 18.000 |
| 42010 | 11013910 | 3,9 x 10 | 5,0-6,5 | 500 | 9.000 |
| 42011 | 11013912 | 3,9 x 12 | 6,5-8,5 | 500 | 9.000 |
| 42012 | 11013915 | 3,9 x 15 | 8,5-11,0 | 500 | 9.000 |
| 42013 | 11013918 | 3,9 x 18 | 11,0-14,5 | 500 | 9.000 |
| 42014 | 11013920 | 3,9 x 20 | 14,5-16,5 | 500 | 9.000 |
| 42015 | 11013924 | 3,9 x 24 | 16,5-21,5 | 500 | 9.000 |

| CODIGO | BROCA Ø5 D2:14/S:1,5 REFERENCIA | MEDIDA 5 D1 x L | ESPESOR | EMBALAJE | |
|--------|---------------------------------------|-----------------------|-----------|----------|----------|
| | | | | INTERIOR | EXTERIOR |
| 42028 | 11014908 | 4,9 x 8 | 0,5-4,5 | 500 | 9.000 |
| 42029 | 11014910 | 4,9 x 10 | 4,5-6,0 | 250 | 4.500 |
| 42030 | 11014912 | 4,9 x 12 | 6,0-8,0 | 250 | 4.500 |
| 42031 | 11014914 | 4,9 x 14 | 8,0-10,0 | 250 | 4.500 |
| 42032 | 11014916 | 4,9 x 16 | 10,0-12,0 | 250 | 4.500 |
| 42033 | 11014918 | 4,9 x 18 | 12,0-14,0 | 250 | 4.500 |
| 42034 | 11014921 | 4,9 x 21 | 14,0-16,0 | 250 | 4.500 |
| 42035 | 11014924 | 4,9 x 24 | 16,0-18,0 | 250 | 4.500 |
| 42036 | 11014927 | 4,9 x 27 | 18,0-21,0 | 250 | 4.500 |
| 42037 | 11014930 | 4,9 x 30 | 21,0-25,0 | 250 | 4.500 |
| 42038 | 11014935 | 4,9 x 35 | 25,0-30,0 | 250 | 4.500 |

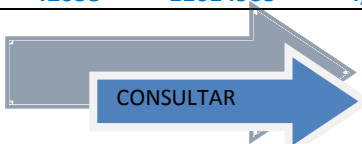

CONSULTE: COLOR -RAL Y DISPONIBILIDAD.

| CODIGO | COLOR | RAL | CODIGO | COLOR | RAL | CODIGO | COLOR | RAL |
|--------|----------|------|--------|---------|------|--------|---------|------|
| 40500 | AMARILLO | 1021 | 40400 | MARRON | 8014 | 4000 | BLANCO | 9010 |
| 40600 | AZUL | 5010 | 41000 | NARANJA | 2004 | 4010 | NEGRO | 9005 |
| 40700 | BRONCE | | 40200 | ORO | | 40800 | BURDEOS | 3004 |
| 41100 | ROJO | 3000 | 40300 | CREMA | 1015 | 41200 | VERDE | 6002 |
| 40900 | GRIS | 7035 | 41300 | VERDE | 6005 | 41400 | PLATA | |

FAMILIA 1102



REMACHE CABEZA GRANDE NEGRO ALU/ACE

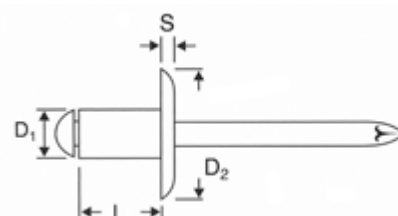

RVET LARGE HEAD LACQUERED (ALUMINIUM-STEEL)

| CODIGO | BROCA \varnothing 4 D2:10/S:1,2 REFERENCIA | MEDIDA 4 D1 x L | ESPESOR | EMBALAJE | |
|--------|--|-----------------------|-----------|----------|----------|
| | | | | INTERIOR | EXTERIOR |
| 42108 | 11023906 | 3,9 x 6 | 1,5-3,0 | 1.000 | 18.000 |
| 42109 | 11023908 | 3,9 x 8 | 3,0-5,0 | 1.000 | 18.000 |
| 42110 | 11023910 | 3,9 x 10 | 5,0-6,5 | 500 | 9.000 |
| 42111 | 11023912 | 3,9 x 12 | 6,5-8,5 | 500 | 9.000 |
| 42112 | 11023915 | 3,9 x 15 | 8,5-11,0 | 500 | 9.000 |
| 42113 | 11023918 | 3,9 x 18 | 11,0-14,5 | 500 | 9.000 |
| 42114 | 11023920 | 3,9 x 20 | 14,5-16,5 | 500 | 9.000 |
| 42115 | 11023924 | 3,9 x 24 | 16,5-21,5 | 500 | 9.000 |

| CODIGO | BROCA \varnothing 5 D2:14/S:1,5 REFERENCIA | MEDIDA 5 D1 x L | ESPESOR | EMBALAJE | |
|--------|--|-----------------------|-----------|----------|----------|
| | | | | INTERIOR | EXTERIOR |
| 42128 | 11024908 | 4,9 x 8 | 0,5-4,5 | 500 | 9.000 |
| 42129 | 11024910 | 4,9 x 10 | 4,5-6,0 | 250 | 4.500 |
| 42130 | 11024912 | 4,9 x 12 | 6,0-8,0 | 250 | 4.500 |
| 42131 | 11024914 | 4,9 x 14 | 8,0-10,0 | 250 | 4.500 |
| 42132 | 11024916 | 4,9 x 16 | 10,0-12,0 | 250 | 4.500 |
| 42133 | 11024918 | 4,9 x 18 | 12,0-14,0 | 250 | 4.500 |
| 42134 | 11024921 | 4,9 x 21 | 14,0-16,0 | 250 | 4.500 |
| 42135 | 11024924 | 4,9 x 24 | 16,0-18,0 | 250 | 4.500 |
| 42136 | 11024927 | 4,9 x 27 | 18,0-21,0 | 250 | 4.500 |
| 42137 | 11024930 | 4,9 x 30 | 21,0-25,0 | 250 | 4.500 |
| 42138 | 11024935 | 4,9 x 35 | 25,0-30,0 | 250 | 4.500 |

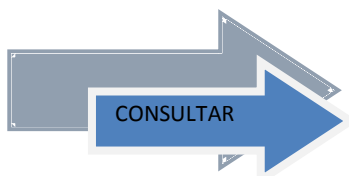

CONSULTE: COLOR -RAL Y DISPONIBILIDAD.

| COLOR | RAL | COLOR | RAL | COLOR | RAL |
|----------|------|---------|------|---------|------|
| AMARILLO | 1021 | MARRON | 8014 | BLANCO | 9010 |
| AZUL | 5010 | NARANJA | 2004 | NEGRO | 9005 |
| BRONCE | | ORO | | BURDEOS | 3004 |
| ROJO | 3000 | CREMA | 1015 | VERDE | 6002 |
| GRIS | 7035 | VERDE | 6005 | PLATA | |

FAMILIA 1200

REMACHE CABEZA EXTRA GRANDE ALU/ACE

RVET EXTRA LARGE HEAD (ALUMINIUM-STEEL)

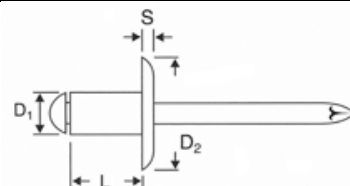

| CODIGO | BROCA Ø3,25 | MEDIDA 3,2 | ESPEJOR | EMBALAJE | |
|--------|--------------------------|---------------|-----------|----------|----------|
| | D2:9/S:1,0 REFERENCIA | | | D1 x L | INTERIOR |
| 21000 | 12003206 | 3,2 x 6 | 0,5-3,5 | 500 | 9.000 |
| 21002 | 12003208 | 3,2 x 8 | 3,5-5,5 | 500 | 9.000 |
| 21003 | 12003210 | 3,2 x 10 | 5,5-7,0 | 500 | 9.000 |
| 21004 | 12003212 | 3,2 x 12 | 7,0-9,0 | 500 | 9.000 |
| 21005 | 12003215 | 3,2 x 15 | 9,0-12,0 | 500 | 9.000 |
| 21006 | 12003218 | 3,2 x 18 | 12,0-15,0 | 500 | 9.000 |

| CODIGO | BROCA Ø4 | MEDIDA 4 | ESPEJOR | EMBALAJE | |
|--------|---------------------------|-------------|-----------|----------|----------|
| | D2:12/S:1,2 REFERENCIA | | | D1 x L | INTERIOR |
| 21010 | 12003906 | 3,9 x 6 | 1,5-3,0 | 500 | 9.000 |
| 21011 | 12003908 | 3,9 x 8 | 3,0-5,0 | 500 | 9.000 |
| 21012 | 12003910 | 3,9 x 10 | 5,0-6,5 | 500 | 9.000 |
| 21013 | 12003912 | 3,9 x 12 | 6,5-8,5 | 500 | 9.000 |
| 21014 | 12003915 | 3,9 x 15 | 8,5-11,0 | 500 | 9.000 |
| 21015 | 12003918 | 3,9 x 18 | 11,0-14,5 | 500 | 9.000 |
| 21016 | 12003920 | 3,9 x 20 | 14,5-16,5 | 500 | 9.000 |
| 21017 | 12003924 | 3,9 x 24 | 16,5-20,5 | 500 | 9.000 |

| CODIGO | BROCA Ø5 | MEDIDA 5 | ESPEJOR | EMBALAJE | |
|--------|---------------------------|-------------|-----------|----------|----------|
| | D2:16/S:1,5 REFERENCIA | | | D1 x L | INTERIOR |
| 21020 | 12004908 | 4,9 x 8 | 0,5-4,5 | 500 | 4.500 |
| 21021 | 12004910 | 4,9 x 10 | 4,5-6,0 | 250 | 4.500 |
| 21022 | 12004912 | 4,9 x 12 | 6,0-8,0 | 250 | 4.500 |
| 21023 | 12004914 | 4,9 x 14 | 8,0-10,0 | 250 | 4.500 |
| 21024 | 12004916 | 4,9 x 16 | 10,0-12,0 | 250 | 4.500 |
| 21025 | 12004918 | 4,9 x 18 | 12,0-14,0 | 250 | 4.500 |
| 21026 | 12004921 | 4,9 x 21 | 14,0-16,0 | 250 | 4.500 |
| 21027 | 12004924 | 4,9 x 24 | 16,0-18,0 | 250 | 4.500 |
| 21028 | 12004927 | 4,9 x 27 | 18,0-21,0 | 200 | 3.600 |
| 21029 | 12004930 | 4,9 x 30 | 21,0-25,0 | 200 | 3.600 |
| 21030 | 12004935 | 4,9 x 35 | 25,0-30,0 | 200 | 3.600 |

FAMILIA 1201

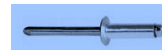

REMACHE CAB. EXTRA GRANDE LC.BLANCO

ALU/ACE

RVET EXTRA LARGE HEAD LACQUERED (ALUMINIUM-STEEL)

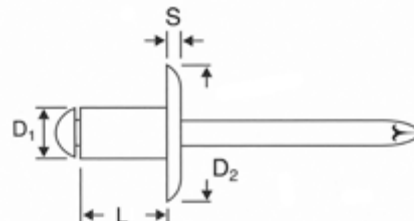

| CODIGO | BROCA Ø4 D2:12/S:1,2 REFERENCIA | MEDIDA 4 D1 x L | ESPEJOR | EMBALAJE | |
|--------|---------------------------------------|-----------------------|-----------|----------|----------|
| | | | | INTERIOR | EXTERIOR |
| 00007 | 12013906 | 3,9 x 6 | 1,5-3,0 | 500 | 9.000 |
| 00008 | 12013908 | 3,9 x 8 | 3,0-5,0 | 500 | 9.000 |
| 00009 | 12013910 | 3,9 x 10 | 5,0-6,5 | 500 | 9.000 |
| 00010 | 12013912 | 3,9 x 12 | 6,5-8,5 | 500 | 9.000 |
| 00011 | 12013915 | 3,9 x 15 | 8,5-11,0 | 500 | 9.000 |
| 00012 | 12013918 | 3,9 x 18 | 11,0-14,5 | 500 | 9.000 |
| 00013 | 12013920 | 3,9 x 20 | 14,5-16,5 | 500 | 9.000 |
| 00014 | 12013924 | 3,9 X 24 | 16,5-20,5 | 500 | 9.000 |

| CODIGO | BROCA Ø5 D2:16/S:1,5 REFERENCIA | MEDIDA 5 D1 x L | ESPEJOR | EMBALAJE | |
|--------|---------------------------------------|-----------------------|-----------|----------|----------|
| | | | | INTERIOR | EXTERIOR |
| 00015 | 12014908 | 4,9 x 8 | 0,5-4,5 | 500 | 4.500 |
| 00016 | 12014910 | 4,9 x 10 | 4,5-6,0 | 250 | 4.500 |
| 00017 | 12014912 | 4,9 x 12 | 6,0-8,0 | 250 | 4.500 |
| 00018 | 12014914 | 4,9 x 14 | 8,0-10,0 | 250 | 4.500 |
| 00019 | 12014916 | 4,9 x 16 | 10,0-12,0 | 250 | 4.500 |
| 21433 | 12014918 | 4,9 x 18 | 12,0-14,0 | 250 | 4.500 |
| 00020 | 12014921 | 4,9 x 21 | 14,0-16,0 | 250 | 4.500 |
| 00021 | 12014924 | 4,9 x 24 | 16,0-18,0 | 250 | 4.500 |
| 00022 | 12014927 | 4,9 x 27 | 18,0-21,0 | 200 | 3.600 |
| 00023 | 12014930 | 4,9 x 30 | 21,0-25,0 | 200 | 3.600 |
| 00024 | 12014935 | 4,9 x 35 | 25,0-30,0 | 200 | 3.600 |

FABRICACION BAJO PEDIDO

CONSULTE: COLOR -RAL Y DISPONIBILIDAD.

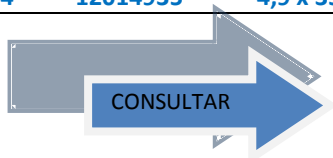

| COLOR | RAL | COLOR | RAL | COLOR | RAL |
|----------|------|---------|------|---------|------|
| AMARILLO | 1021 | MARRON | 8014 | BLANCO | 9010 |
| AZUL | 5010 | NARANJA | 2004 | NEGRO | 9005 |
| BRONCE | | ORO | | BURDEOS | 3004 |
| ROJO | 3000 | CREMA | 1015 | VERDE | 6002 |
| GRIS | 7035 | VERDE | 6005 | PLATA | |

FAMILIA 1202



REMACHE CAB. EXTRA GRANDE LC.NEGRO

ALU/ACE

RIVET EXTRA LARGE HEAD LACQUERED (ALUMINIUM-STEEL)

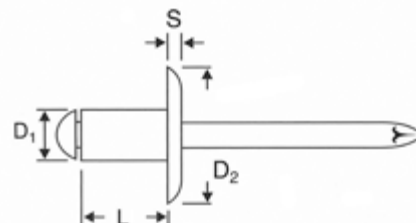

| CODIGO | BROCA Ø4 D2:12/S:1,2 REFERENCIA | MEDIDA 4 D1 x L | ESPESOR | EMBALAJE | |
|--------|---------------------------------------|-----------------------|-----------|----------|----------|
| | | | | INTERIOR | EXTERIOR |
| 00030 | 12023906 | 3,9 x 6 | 1,5-3,0 | 500 | 9.000 |
| 00031 | 12023908 | 3,9 x 8 | 3,0-5,0 | 500 | 9.000 |
| 00032 | 12023910 | 3,9 x 10 | 5,0-6,5 | 500 | 9.000 |
| 00033 | 12023912 | 3,9 x 12 | 6,5-8,5 | 500 | 9.000 |
| 00034 | 12023915 | 3,9 x 15 | 8,5-11,0 | 500 | 9.000 |
| 00035 | 12023918 | 3,9 x 18 | 11,0-14,5 | 500 | 9.000 |
| 00036 | 12023920 | 3,9 x 20 | 14,5-16,5 | 500 | 9.000 |
| 00037 | 12023924 | 3,9 X 24 | 16,5-20,5 | 500 | 9.000 |

| CODIGO | BROCA Ø5 D2:16/S:1,5 REFERENCIA | MEDIDA 5 D1 x L | ESPESOR | EMBALAJE | |
|--------|---------------------------------------|-----------------------|-----------|----------|----------|
| | | | | INTERIOR | EXTERIOR |
| 00038 | 12024908 | 4,9 x 8 | 0,5-4,5 | 500 | 4.500 |
| 00039 | 12024910 | 4,9 x 10 | 4,5-6,0 | 250 | 4.500 |
| 00040 | 12024912 | 4,9 x 12 | 6,0-8,0 | 250 | 4.500 |
| 00041 | 12024914 | 4,9 x 14 | 8,0-10,0 | 250 | 4.500 |
| 00042 | 12024916 | 4,9 x 16 | 10,0-12,0 | 250 | 4.500 |
| 00043 | 12024918 | 4,9 x 18 | 12,0-14,0 | 250 | 4.500 |
| 00044 | 12024921 | 4,9 x 21 | 14,0-16,0 | 250 | 4.500 |
| 00045 | 12024921 | 4,9 x 24 | 16,0-18,0 | 250 | 4.500 |
| 00046 | 12024927 | 4,9 x 27 | 18,0-21,0 | 200 | 3.600 |
| 00047 | 12024930 | 4,9 x 30 | 21,0-25,0 | 200 | 3.600 |
| 00048 | 12024935 | 4,9 x 35 | 25,0-30,0 | 200 | 3.600 |

FABRICACION BAJO PEDIDO



CONSULTE: COLOR -RAL Y DISPONIBILIDAD.

| COLOR | RAL | COLOR | RAL | COLOR | RAL |
|----------|------|---------|------|---------|------|
| AMARILLO | 1021 | MARRON | 8014 | BLANCO | 9010 |
| AZUL | 5010 | NARANJA | 2004 | NEGRO | 9005 |
| BRONCE | | ORO | | BURDEOS | 3004 |
| ROJO | 3000 | CREMA | 1015 | VERDE | 6002 |
| GRIS | 7035 | VERDE | 6005 | PLATA | |

FAMILIA 1300

REMACHES AVELLANADO (ALUMINIO – ACERO)

RIVET COUNTERSUNK HEAD (ALUMINIUM-STEEL)

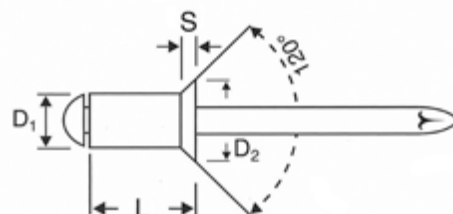

| CODIGO | BROCA Ø2,5 D2:5/S:0.55 REFERENCIA | MEDIDA 2,4 D1 x L | ESPESOR | EMBALAJE | |
|--------|---|-------------------------|---------|----------|----------|
| | | | | INTERIOR | EXTERIOR |
| 21844 | 13002406 | 2,4 x 6 | 2,0-4,0 | 1.000 | 18.000 |
| 21843 | 13002408 | 2,4 x 8 | 4,0-6,0 | 1.000 | 18.000 |
| 21846 | 13002410 | 2,4 x 10 | 6,0-8,0 | 1.000 | 18.000 |

| CODIGO | BROCA Ø3,0 D2:5.8/S:1 REFERENCIA | MEDIDA 3 D1 x L | ESPESOR | EMBALAJE | |
|--------|--|-----------------------|-----------|----------|----------|
| | | | | INTERIOR | EXTERIOR |
| 50100 | 13002906 | 2,9 x 6 | 1,5-3,5 | 1.000 | 18.000 |
| 50101 | 13002908 | 2,9 x 8 | 3,5-5,5 | 1.000 | 18.000 |
| 50102 | 13002910 | 2,9 x 10 | 5,5-7,0 | 1.000 | 18.000 |
| 50103 | 13002912 | 2,9 x 12 | 7,0-9,0 | 1.000 | 18.000 |
| 50104 | 13002914 | 2,9 x 14 | 9,0-11,0 | 1.000 | 18.000 |
| 50106 | 13002916 | 2,9 x 16 | 11,0-13,0 | 1.000 | 18.000 |

| CODIGO | BROCA Ø3,25 D2:6.5/S:1 REFERENCIA | MEDIDA 3,2 D1 x L | ESPESOR | EMBALAJE | |
|--------|---|-------------------------|-----------|----------|----------|
| | | | | INTERIOR | EXTERIOR |
| 50110 | 13003206 | 3,2 x 6 | 1,5-3,5 | 1.000 | 18.000 |
| 50111 | 13003208 | 3,2 x 8 | 3,5-5,5 | 1.000 | 18.000 |
| 50112 | 13003210 | 3,2 x 10 | 5,5-7,0 | 1.000 | 18.000 |
| 50113 | 13003212 | 3,2 x 12 | 7,0-9,0 | 1.000 | 18.000 |
| 50114 | 13003214 | 3,2 x 14 | 9,0-11,0 | 1.000 | 18.000 |
| 50115 | 13003216 | 3,2 x 16 | 11,0-13,0 | 1.000 | 18.000 |
| 50116 | 13003218 | 3,2 x 18 | 13,0-15,0 | 1.000 | 18.000 |

REMACHES AVELLANADO (ALUMINIO – ACERO)

RIVET COUNTERSUNK HEAD (ALUMINIUM-STEEL)

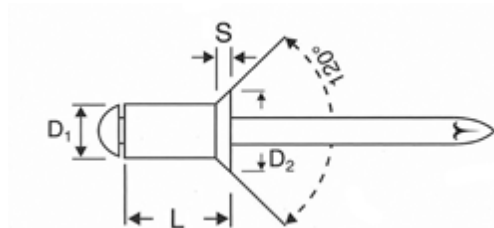

| CODIGO | BROCA Ø4 D2:8,1/S:1,2 REFERENCIA | MEDIDA 4 D1 x L | ESPESOR | EMBALAJE | |
|--------|--|-----------------------|-----------|----------|----------|
| | | | | INTERIOR | EXTERIOR |
| 50120 | 13003906 | 3,9 x 6 | 0,5-3,0 | 1.000 | 18.000 |
| 50121 | 13003908 | 3,9 x 8 | 3,0-5,0 | 1.000 | 18.000 |
| 50122 | 13003910 | 3,9 x 10 | 5,0-6,5 | 500 | 9.000 |
| 50123 | 13003912 | 3,9 x 12 | 6,5-8,5 | 500 | 9.000 |
| 50124 | 13003915 | 3,9 x 15 | 8,5-12,5 | 500 | 9.000 |
| 50125 | 13003918 | 3,9 x 18 | 12,5-14,5 | 500 | 9.000 |
| 50126 | 13003920 | 3,9 x 20 | 14,5-16,5 | 500 | 9.000 |

| CODIGO | BROCA Ø5 D2:9,5/S:1,4 REFERENCIA | MEDIDA 5 D1 x L | ESPESOR | EMBALAJE | |
|--------|--|-----------------------|-----------|----------|----------|
| | | | | INTERIOR | EXTERIOR |
| 50130 | 13004906 | 4,9 x 6 | 0,5-3,0 | 500 | 9.000 |
| 50131 | 13004908 | 4,9 x 8 | 3,0-4,5 | 500 | 9.000 |
| 50132 | 13004910 | 4,9 x 10 | 4,5-6,0 | 500 | 9.000 |
| 50133 | 13004912 | 4,9 x 12 | 6,0-8,0 | 500 | 9.000 |
| 50134 | 13004915 | 4,9 x 15 | 8,0-11,0 | 500 | 9.000 |
| 50135 | 13004818 | 4,9 x 18 | 11,0-14,0 | 500 | 9.000 |
| 50136 | 13004921 | 4,9 x 21 | 14,0-17,0 | 250 | 4.500 |
| 50137 | 13004924 | 4,9 x 24 | 17,0-20,0 | 250 | 4.500 |
| 50138 | 13004927 | 4,9 x 27 | 20,0-23,0 | 250 | 4.500 |
| 50139 | 13004930 | 4,9 x 30 | 23,0-25,0 | 250 | 4.500 |
| 50140 | 13004935 | 4,9 x 35 | 25,0-30,0 | 250 | 4.500 |

FAMILIA 1301 REMACHE AVELLANADO LACADO BLANCO

FAMILIA 1302 REMACHE AVELLANADO LACADO NEGRO

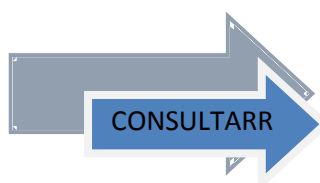

CONSULTE: COLOR –RAL Y DISPONIBILIDAD.

| COLOR | RAL | COLOR | RAL | COLOR | RAL |
|----------|------|---------|------|---------|------|
| AMARILLO | 1021 | MARRON | 8014 | BLANCO | 9010 |
| AZUL | 5010 | NARANJA | 2004 | NEGRO | 9005 |
| BRONCE | | ORO | | BURDEOS | 3004 |
| ROJO | 3000 | CREMA | 1015 | VERDE | 6002 |
| GRIS | 7035 | VERDE | 6005 | PLATA | |

FAMILIA 1400

REMACHES ACERO – ACERO

RIVETS STEEL-STEEL

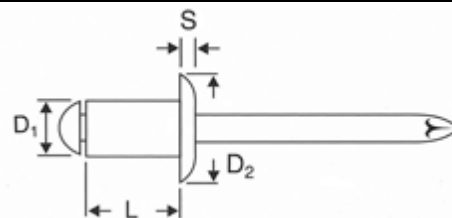

| CODIGO | BROCA Ø3,1 D2:6.5/S:0.8 REFERENCIA | MEDIDA 3 D1 x L | ESPESOR | EMBALAJE INTERIOR | EMBALAJE EXTERIOR. |
|--------|--|-----------------------|----------|----------------------|-----------------------|
| 49999 | 14003006 | 3 x 6 | 1.5-3.0 | 1.000 | 18.000 |
| 49996 | 14003008 | 3 x 8 | 3.0-5.0 | 1.000 | 18.000 |
| 49998 | 14003010 | 3 x 10 | 5.0-7.0 | 1.000 | 18.000 |
| 49997 | 14003012 | 3 x 12 | 7.0-9.02 | 1.000 | 18.000 |
| 49995 | 14003014 | 3 x 14 | 9.0-11.0 | 1.000 | 18.000 |

| CODIGO | BROCA Ø3,25 D2:6.5/S:0.8 REFERENCIA | MEDIDA 3,2 D1 x L | ESPESOR | EMBALAJE INTERIOR | EMBALAJE EXTERIOR |
|--------|---|-------------------------|-----------|----------------------|----------------------|
| 50001 | 14003206 | 3.2 x 6 | 1.5-3.0 | 1.000 | 18.000 |
| 50002 | 14003208 | 3.2 x 8 | 3.0-5.0 | 1.000 | 18.000 |
| 50006 | 14003210 | 3.2 x 10 | 5.0-7.0 | 1.000 | 18.000 |
| 50007 | 14003212 | 3.2 x 12 | 7.0-9.02 | 1.000 | 18.000 |
| 49994 | 14003214 | 3.2 x 14 | 9.0-11.0 | 1.000 | 18.000 |
| 49993 | 14003216 | 3.2 x 16 | 11.0-13.0 | 1.000 | 18.000 |

| CODIGO | BROCA Ø4.1 D2:8/S:1 REFERENCIA | MEDIDA 4 D1 x L | ESPESOR | EMBALAJE INTERIOR | EMBALAJE EXTERIOR |
|--------|--------------------------------------|-----------------------|-----------|----------------------|----------------------|
| 50008 | 14004006 | 4 x 6 | 1.5-2.5 | 1.000 | 18.000 |
| 50009 | 14004008 | 4 x 8 | 2.5-4.5 | 1.000 | 18.000 |
| 50010 | 14004010 | 4 x 10 | 4.5-6.5 | 500 | 9.000 |
| 50011 | 14004012 | 4 x 12 | 6.5-8.5 | 500 | 9.000 |
| 50012 | 14004014 | 4 x 14 | 8.5-10.5 | 500 | 9.000 |
| 50019 | 14004016 | 4 x 16 | 10.5-12.5 | 500 | 9.000 |
| 50013 | 14004018 | 4 x 18 | 12.5-14.5 | 500 | 9.000 |
| 50014 | 14004020 | 4 x 20 | 14.5-16.5 | 500 | 9.000 |

REMACHES ACERO - ACERO

RIVETS STEEL-STEEL

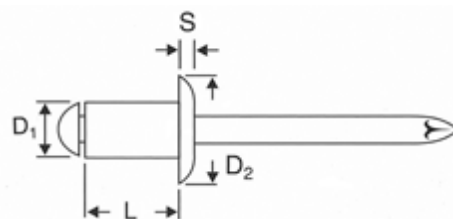

| CODIGO | BROCA Ø5 D2:9.5/S:1.1 REFERENCIA | MEDIDA 4.9 D1 x L | ESPEJOR | EMBALAJE | |
|--------|--|-------------------------|-----------|----------|----------|
| | | | | INTERIOR | EXTERIOR |
| 50027 | 14004906 | 4,9 x 6 | 1.0-2.5 | 500 | 9.000 |
| 50028 | 14004908 | 4,9 x 8 | 2.5-4.5 | 500 | 9.000 |
| 50029 | 14004910 | 4,9 x 10 | 4.5-6.0 | 500 | 9.000 |
| 50030 | 14004912 | 4,9 x 12 | 6.0-8.0 | 500 | 9.000 |
| 50031 | 14004914 | 4,9 x 14 | 8.0-10.0 | 500 | 9.000 |
| 50032 | 14004916 | 4,9 x 16 | 10.0-11.5 | 500 | 9.000 |
| 50033 | 14004918 | 4,9 x 18 | 11.5-13.5 | 500 | 9.000 |
| 50034 | 14004920 | 4,9 x 20 | 13.5-15.0 | 500 | 9.000 |
| 50036 | 14004922 | 4,9 x 22 | 15.0-17.0 | 500 | 9.000 |
| 50035 | 14004925 | 4,9 x 25 | 17.0-20.0 | 500 | 9.000 |
| 50038 | 14004928 | 4,9 x 28 | 20.0-23.0 | 500 | 9.000 |
| 50037 | 14004930 | 4,9 x 30 | 23.0-26.0 | 500 | 9.000 |

| CODIGO | BROCA Ø6.1 D2:12/S:1.5 REFERENCIA | MEDIDA 6 D1 x L | ESPEJOR | EMBALAJE | |
|--------|---|-----------------------|-----------|----------|----------|
| | | | | INTERIOR | EXTERIOR |
| 50611 | 14006012 | 6 x 12 | 3.5-6.5 | 250 | 4.500 |
| 50129 | 14006015 | 6 x 15 | 6.5-9.5 | 250 | 4.500 |
| 50613 | 14006018 | 6 x 18 | 9.5-12.5 | 250 | 4.500 |
| 50614 | 14006022 | 6 x 22 | 14.5-16.5 | 250 | 4.500 |
| 50616 | 14006026 | 6 x 26 | 17.5-20.5 | 250 | 4.500 |
| 50617 | 14006030 | 6 x 30 | 21.5-24.5 | 250 | 4.500 |

| CODIGO | BROCA Ø6.5 D2:13/S:1.8 REFERENCIA | MEDIDA 6.4 D1 x L | ESPEJOR | EMBALAJE | |
|--------|---|-------------------------|-----------|----------|----------|
| | | | | INTERIOR | EXTERIOR |
| 50039 | 14006412 | 6,4 x 12 | 3.5-6.5 | 250 | 4.500 |
| 50042 | 14006415 | 6,4x 15 | 6.5-9.5 | 250 | 4.500 |
| 50040 | 14006418 | 6,4 x 18 | 9.5-12.5 | 250 | 4.500 |
| 50041 | 14006422 | 6,4 x 22 | 14.5-16.5 | 250 | 4.500 |
| 50043 | 14006426 | 6,4 x 26 | 17.5-20.5 | 250 | 4.500 |
| 50044 | 14006430 | 6,4 x 30 | 21.5-24.5 | 250 | 4.500 |

FAMILIA 1410

REMACHES ACERO ACERO ALA ANCHA

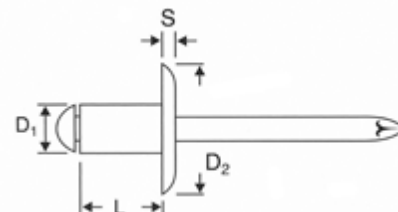

RIVETS STEEL STEEL LARGE HEAD

| CODIGO | BROCA $\varnothing 3,25$ D2:9.5/S:2 REFERENCIA | MEDIDA 3,2 D1 x L | ESPESOR | EMBALAJE | |
|--------|--|-------------------------|----------|----------|----------|
| | | | | INTERIOR | EXTERIOR |
| 00382 | 14103206 | 3.2 x 6 | 1.5-3.0 | 1.000 | 18.000 |
| 00383 | 14103208 | 3.2 x 8 | 3.0-5.0 | 1.000 | 18.000 |
| 00384 | 14103210 | 3.2 x 10 | 5.0-7.0 | 1.000 | 18.000 |
| 00385 | 14103212 | 3.2 x 12 | 7.0-9.02 | 1.000 | 18.000 |
| 00382 | 14103214 | 3.2 x 14 | 9.0-11.0 | 1.000 | 18.000 |

| CODIGO | BROCA $\varnothing 4.1$ D2:12/S:1.4 REFERENCIA | MEDIDA 4 D1 x L | ESPESOR | EMBALAJE | |
|--------|--|-----------------------|-----------|----------|----------|
| | | | | INTERIOR | EXTERIOR |
| 00387 | 14104008 | 4 x 8 | 2.5-4.5 | 1.000 | 18.000 |
| 00388 | 14104010 | 4 x 10 | 4.5-6.5 | 500 | 9.000 |
| 00389 | 14104012 | 4 x 12 | 6.5-8.5 | 500 | 9.000 |
| 00390 | 14104014 | 4 x 14 | 8.5-10.5 | 500 | 9.000 |
| 00386 | 14104016 | 4 x 16 | 10.5-12.5 | 500 | 9.000 |

| CODIGO | BROCA $\varnothing 5$ D2:14/S:1.8 REFERENCIA | MEDIDA 4.9 D1 x L | ESPESOR | EMBALAJE | |
|--------|--|-------------------------|-----------|----------|----------|
| | | | | INTERIOR | EXTERIOR |
| 00393 | 14104910 | 4,9 x 10 | 4.5-6.0 | 500 | 9.000 |
| 00394 | 14104912 | 4,9 x 12 | 6.0-8.0 | 500 | 9.000 |
| 00395 | 14104914 | 4,9 x 14 | 8.0-10.0 | 500 | 9.000 |
| 00396 | 14104916 | 4,9 x 16 | 10.0-11.5 | 500 | 9.000 |
| 00397 | 14104918 | 4,9 x 18 | 11.5-13.5 | 500 | 9.000 |
| 00391 | 14104920 | 4,9 x 20 | 13.5-15.0 | 500 | 9.000 |
| 00392 | 14104922 | 4,9 x 22 | 15.0-17.0 | 500 | 9.000 |

FAMILIA 1430

REMACHES ACERO – ACERO CAB.AVELLANADA

RIVETS STEEL-STEEL COUNTERSUNK HEAD

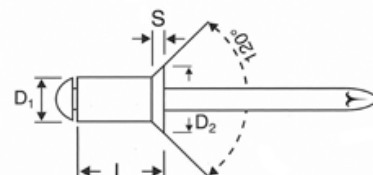

| CODIGO | BROCA Ø3,1 | MEDIDA 3 | ESPESOR | EMBALAJE | |
|--------|------------|-------------|----------|----------|-----------|
| | D2:6/S:0.9 | | | INTERIOR | EXTERIOR. |
| | REFERENCIA | D1 x L | | | |
| 00398 | 14303006 | 3 x 6 | 1.5-3.0 | 1.000 | 18.000 |
| 00399 | 14303008 | 3 x 8 | 3.0-5.0 | 1.000 | 18.000 |
| 00400 | 14303010 | 3 x 10 | 5.0-7.0 | 1.000 | 18.000 |
| 00401 | 14303012 | 3 x 12 | 7.0-9.02 | 1.000 | 18.000 |

| CODIGO | BROCA Ø3,25 | MEDIDA 3.2 | ESPESOR | EMBALAJE | |
|--------|--------------|---------------|----------|----------|-----------|
| | D2:7.5/S:0.9 | | | INTERIOR | EXTERIOR. |
| | REFERENCIA | D1 x L | | | |
| 00402 | 14303206 | 3.2 x 6 | 1.5-3.0 | 1.000 | 18.000 |
| 00403 | 14303208 | 3.2 x 8 | 3.0-5.0 | 1.000 | 18.000 |
| 00404 | 14303210 | 3.2 x 10 | 5.0-7.0 | 1.000 | 18.000 |
| 00405 | 14303212 | 3.2 x 12 | 7.0-9.02 | 1.000 | 18.000 |
| 00406 | 14303214 | 3.2 x 14 | 9.0-11.0 | 1.000 | 18.000 |

| CODIGO | BROCA Ø4.1 | MEDIDA 4 | ESPESOR | EMBALAJE | |
|--------|------------|-------------|-----------|----------|-----------|
| | D2:7.5/S:1 | | | INTERIOR | EXTERIOR. |
| | REFERENCIA | D1 x L | | | |
| 00407 | 14304006 | 4 x 6 | 1.5-2.5 | 1.000 | 18.000 |
| 00408 | 14304008 | 4 x 8 | 2.5-4.5 | 1.000 | 18.000 |
| 00409 | 14304010 | 4 x 10 | 4.5-6.5 | 500 | 9.000 |
| 00410 | 14304012 | 4 x 12 | 6.5-8.5 | 500 | 9.000 |
| 00411 | 14304014 | 4 x 14 | 8.5-10.5 | 500 | 9.000 |
| 00412 | 14304016 | 4 x 16 | 10.5-12.5 | 500 | 9.000 |

| CODIGO | BROCA Ø5 | MEDIDA 4.9 | ESPESOR | EMBALAJE | |
|--------|------------|---------------|-----------|----------|-----------|
| | D2:9/S:1.2 | | | INTERIOR | EXTERIOR. |
| | REFERENCIA | D1 x L | | | |
| 00414 | 14304908 | 4,9 x 8 | 2.5-4.5 | 500 | 9.000 |
| 00415 | 14304910 | 4,9 x 10 | 4.5-6.0 | 500 | 9.000 |
| 00416 | 14304912 | 4,9 x 12 | 6.0-8.0 | 500 | 9.000 |
| 00417 | 14304914 | 4,9 x 14 | 8.0-10.0 | 500 | 9.000 |
| 00418 | 14304916 | 4,9 x 16 | 10.0-11.5 | 500 | 9.000 |
| 00419 | 14304918 | 4,9 x 18 | 11.5-13.5 | 500 | 9.000 |
| 00420 | 14304920 | 4,9 x 20 | 13.5-15.0 | 500 | 9.000 |
| 00413 | 14304922 | 4,9 x 22 | 15.0-17.0 | 500 | 9.000 |

FAMILIA 1500

REMACHES INOX A2

RIVETS STAINLES STEEL A2 DOME HEAD

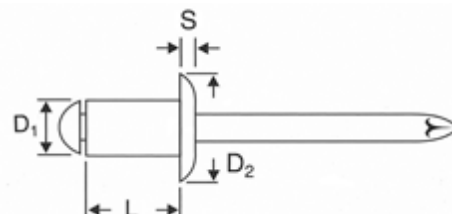

| CODIGO | BROCA Ø3,1 | MEDIDA | ESPESOR | EMBALAJE | |
|--------|--------------|--------|---------|----------|-----------|
| | D2:6.5/S:0.8 | 3 | | INTERIOR | EXTERIOR. |
| | REFERENCIA | D1 x L | | | |
| 70000 | 15003006 | 3 x 6 | 1.5-2.5 | 1.000 | 18.000 |
| 70050 | 15003008 | 3 x 8 | 2.5-4.5 | 1.000 | 18.000 |
| 00421 | 15003010 | 3 x 10 | 4.5-6.5 | 1.000 | 18.000 |
| 69999 | 15003012 | 3 x 12 | 6.5-8.5 | 1.000 | 18.000 |
| 00422 | 15003015 | 3 x 15 | 8.5-12 | 1.000 | 18.000 |

| CODIGO | BROCA Ø3,25 | MEDIDA | ESPESOR | EMBALAJE | |
|--------|--------------|----------|-----------|----------|-----------|
| | D2:6.5/S:0.8 | 3.2 | | INTERIOR | EXTERIOR. |
| | REFERENCIA | D1 x L | | | |
| 70001 | 15003206 | 3.2 x 6 | 1.5-2.5 | 1.000 | 18.000 |
| 70007 | 15003208 | 3.2 x 8 | 2.5-4.5 | 1.000 | 18.000 |
| 70004 | 15003210 | 3.2 x 10 | 4.5-6.5 | 1.000 | 18.000 |
| 70005 | 15003212 | 3.2 x 12 | 6.5-8.5 | 1.000 | 18.000 |
| 70006 | 15003215 | 3.2 x 15 | 8.5-12.0 | 1.000 | 18.000 |
| 00423 | 15003218 | 3.2 x 18 | 12.0-15.0 | 1.000 | 18.000 |

| CODIGO | BROCA Ø4.1 | MEDIDA | ESPESOR | EMBALAJE | |
|--------|------------|--------|-----------|----------|-----------|
| | D2:8/S:1 | 4 | | INTERIOR | EXTERIOR. |
| | REFERENCIA | D1 x L | | | |
| 70008 | 15004006 | 4 x 6 | ~2.0 | 1.000 | 18.000 |
| 70009 | 15004008 | 4 x 8 | 2.0-4.0 | 1.000 | 18.000 |
| 70010 | 15004010 | 4 x 10 | 4.0-6.0 | 500 | 9.000 |
| 70011 | 15004012 | 4 x 12 | 7.0-8.0 | 500 | 9.000 |
| 70012 | 15004014 | 4 x 14 | 8.0-10.0 | 500 | 9.000 |
| 70014 | 15004016 | 4 x 16 | 10.0-12.0 | 500 | 9.000 |
| 70013 | 15004018 | 4 x 18 | 12.0-14.0 | 500 | 9.000 |
| 70015 | 15004020 | 4 x 20 | 14.0-16.0 | 500 | 9.000 |

REMACHES INOX A2

RIVETS STAINLES STEEL A2 DOME HEAD

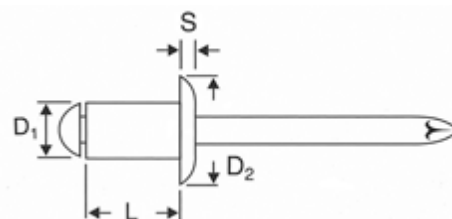

| CODIGO | BROCA Ø5 | MEDIDA | ESPESOR | EMBALAJE | |
|--------|--------------|----------|-----------|----------|-----------|
| | D2:9.5/S:1.1 | 4.9 | | INTERIOR | EXTERIOR. |
| | REFERENCIA | D1 x L | | | |
| 70028 | 15004908 | 4,9 x 8 | 1.5-3.0 | 500 | 9.000 |
| 70029 | 15004910 | 4,9 x 10 | 3.0-5.0 | 500 | 9.000 |
| 70030 | 15004912 | 4,9 x 12 | 5.0-7.0 | 500 | 9.000 |
| 70031 | 15004914 | 4,9 x 14 | 7.0-9.0 | 500 | 9.000 |
| 70032 | 15004916 | 4,9 x 16 | 9.0-11 | 500 | 9.000 |
| 70033 | 15004918 | 4,9 x 18 | 11.0-13.0 | 500 | 9.000 |
| 70034 | 15004920 | 4,9 x 20 | 13.0-15.0 | 250 | 4.500 |
| 70036 | 15004922 | 4,9 x 22 | 15.0-17.0 | 250 | 4.500 |
| 70035 | 15004924 | 4,9 x 24 | 17.0-20.0 | 250 | 4.500 |
| 70038 | 15004927 | 4,9 x 27 | 20.0-23.0 | 250 | 4.500 |
| 70037 | 15004930 | 4,9 x 30 | 23.0-26.0 | 250 | 4.500 |
| 70041 | 15004935 | 4,9 x 35 | 26.0-30.0 | 250 | 4.500 |

| CODIGO | BROCA Ø6.1 | MEDIDA | ESPESOR | EMBALAJE | |
|--------|-------------|--------|-----------|----------|-----------|
| | D2:12/S:1.5 | 6 | | INTERIOR | EXTERIOR. |
| | REFERENCIA | D1 x L | | | |
| 69988 | 15006012 | 6 x 12 | 4.0-6.0 | 250 | 4.500 |
| 69989 | 15006015 | 6 x 15 | 6.0-9.0 | 250 | 4.500 |
| 69990 | 15006018 | 6 x 18 | 9.0-12.0 | 250 | 4.500 |
| 69991 | 15006020 | 6 x 20 | 11.0-14.0 | 250 | 4.500 |

| CODIGO | BROCA Ø6.5 | MEDIDA | ESPESOR | EMBALAJE | |
|--------|-------------|----------|-----------|----------|-----------|
| | D2:13/S:1.8 | 6.4 | | INTERIOR | EXTERIOR. |
| | REFERENCIA | D1 x L | | | |
| 69992 | 15006412 | 6,4 x 12 | 4.5-6.5 | 250 | 4.500 |
| 69993 | 15006415 | 6,4x 15 | 6.5-9.5 | 250 | 4.500 |
| 69994 | 15006418 | 6,4 x 18 | 9.5-12.5 | 250 | 4.500 |
| 69995 | 15006420 | 6,4 x 20 | 11.5-14.5 | 250 | 4.500 |
| 69996 | 15006425 | 6,4 x 25 | 17.0-20.0 | 250 | 4.500 |

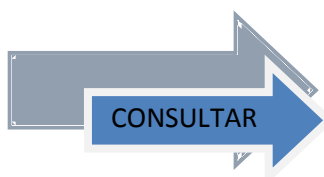

REMACHE INOX A4

FAMILIA 1510

REMACHES INOX A2 ALA ANCHA

RIVETS STAINLES STEEL A2 LARGE HEAD

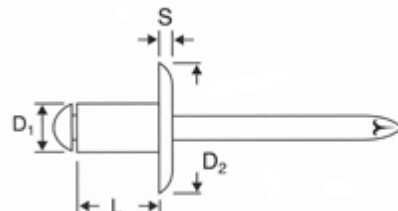

| CODIGO | BROCA Ø3.25 | MEDIDA | ESPESOR | EMBALAJE | |
|--------|--------------|----------|----------|----------|-----------|
| | D2:9.5/S:1.4 | 3.2 | | INTERIOR | EXTERIOR. |
| | REFERENCIA | D1 x L | | | |
| 00424 | 15103206 | 3.2 x 6 | 1.5-2.5 | 1.000 | 18.000 |
| 00425 | 15103208 | 3.2 x 8 | 2.5-4.5 | 1.000 | 18.000 |
| 00426 | 15003210 | 3.2 x 10 | 4.5-6.5 | 1.000 | 18.000 |
| 00427 | 15003212 | 3.2 x 12 | 6.5-8.5 | 1.000 | 18.000 |
| 00428 | 15003215 | 3.2 x 15 | 8.5-12.0 | 1.000 | 18.000 |

| CODIGO | BROCA Ø4.1 | MEDIDA | ESPESOR | EMBALAJE | |
|--------|-------------|--------|-----------|----------|-----------|
| | D2:12/S:1.6 | 4 | | INTERIOR | EXTERIOR. |
| | REFERENCIA | D1 x L | | | |
| 00429 | 15104006 | 4 x 6 | ~2.0 | 1.000 | 18.000 |
| 00430 | 15104008 | 4 x 8 | 2.0-4.0 | 1.000 | 18.000 |
| 00431 | 15104010 | 4 x 10 | 4.0-6.0 | 500 | 9.000 |
| 00432 | 15104012 | 4 x 12 | 7.0-9.0 | 500 | 9.000 |
| 00433 | 15104016 | 4 x 16 | 10.0-12.0 | 500 | 9.000 |

| CODIGO | BROCA Ø5 | MEDIDA | ESPESOR | EMBALAJE | |
|--------|-------------|----------|-----------|----------|-----------|
| | D2:14/S:1.6 | 4.9 | | INTERIOR | EXTERIOR. |
| | REFERENCIA | D1 x L | | | |
| 00434 | 15104908 | 4,9 x 8 | 1.5-3.0 | 500 | 9.000 |
| 00435 | 15104910 | 4,9 x 10 | 3.0-5.0 | 500 | 9.000 |
| 00436 | 15104912 | 4,9 x 12 | 5.0-7.0 | 500 | 9.000 |
| 00437 | 15104914 | 4,9 x 14 | 7.0-9.0 | 500 | 9.000 |
| 00438 | 15104916 | 4,9 x 16 | 9.0-11 | 500 | 9.000 |
| 00439 | 15104918 | 4,9 x 18 | 11.0-13.0 | 500 | 9.000 |
| 00434 | 15104920 | 4,9 x 20 | 13.0-15.0 | 250 | 4.500 |

FAMILIA 1530

REMACHES INOX A2 CAB.AVELLANADA

RIVETS STAINLES STEEL COUNTERSUNK HEAD

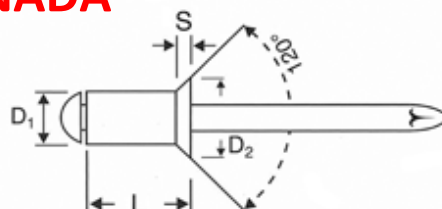

| CODIGO | BROCA Ø3.1 | MEDIDA | ESPESOR | EMBALAJE | EMBALAJE |
|--------|------------|--------|----------|----------|-----------|
| | D2:6/S:1.3 | 3 | | INTERIOR | EXTERIOR. |
| | REFERENCIA | D1 x L | | | |
| 00440 | 15303006 | 3 x 6 | 1.5-3.0 | 1.000 | 18.000 |
| 00441 | 15303008 | 3 x 8 | 3.0-5.0 | 1.000 | 18.000 |
| 00442 | 15303010 | 3 x 10 | 5.0-7.0 | 1.000 | 18.000 |
| 00443 | 15303012 | 3 x 12 | 7.0-9.02 | 1.000 | 18.000 |

| CODIGO | BROCA Ø3.25 | MEDIDA | ESPESOR | EMBALAJE | EMBALAJE |
|--------|--------------|----------|----------|----------|-----------|
| | D2:6.0/S:1.3 | 3.2 | | INTERIOR | EXTERIOR. |
| | REFERENCIA | D1 x L | | | |
| 00444 | 15303206 | 3.2 x 6 | 1.5-3.0 | 1.000 | 18.000 |
| 00445 | 15303208 | 3.2 x 8 | 3.0-5.0 | 1.000 | 18.000 |
| 00446 | 15303210 | 3.2 x 10 | 5.0-7.0 | 1.000 | 18.000 |
| 00447 | 15303212 | 3.2 x 12 | 7.0-9.02 | 1.000 | 18.000 |

| CODIGO | BROCA Ø4.1 | MEDIDA | ESPESOR | EMBALAJE | EMBALAJE |
|--------|--------------|--------|-----------|----------|-----------|
| | D2:7.5/S:1.3 | 4 | | INTERIOR | EXTERIOR. |
| | REFERENCIA | D1 x L | | | |
| 00448 | 15304006 | 4 x 6 | 1.5-2.5 | 1.000 | 18.000 |
| 00449 | 15304008 | 4 x 8 | 2.5-4.5 | 1.000 | 18.000 |
| 00450 | 15304010 | 4 x 10 | 4.5-6.5 | 500 | 9.000 |
| 00451 | 15304012 | 4 x 12 | 6.5-8.5 | 500 | 9.000 |
| 00452 | 15304014 | 4 x 14 | 8.5-10.5 | 500 | 9.000 |
| 00453 | 15304016 | 4 x 16 | 10.5-12.5 | 500 | 9.000 |

| CODIGO | BROCA Ø5 | MEDIDA | ESPESOR | EMBALAJE | EMBALAJE |
|--------|------------|----------|-----------|----------|-----------|
| | D2:9/S:1.3 | 4.9 | | INTERIOR | EXTERIOR. |
| | REFERENCIA | D1 x L | | | |
| 00454 | 15304908 | 4,9 x 8 | 2.5-4.5 | 500 | 9.000 |
| 00455 | 15304910 | 4,9 x 10 | 4.5-6.0 | 500 | 9.000 |
| 00456 | 15304912 | 4,9 x 12 | 6.0-8.0 | 500 | 9.000 |
| 00457 | 15304914 | 4,9 x 14 | 8.0-10.0 | 500 | 9.000 |
| 00458 | 15304916 | 4,9 x 16 | 10.0-11.5 | 500 | 9.000 |
| 00459 | 15304918 | 4,9 x 18 | 11.5-13.5 | 500 | 9.000 |
| 00460 | 15304921 | 4,9 x 21 | 13.5-15.0 | 500 | 9.000 |
| 00461 | 15304925 | 4,9 x 25 | 15.0-17.0 | 500 | 9.000 |

FAMILIA 1600

REMACHES ALUMINIO – ALUMINIO

RIVETES ALUMIUM ALUMINIUM DOME HEAD

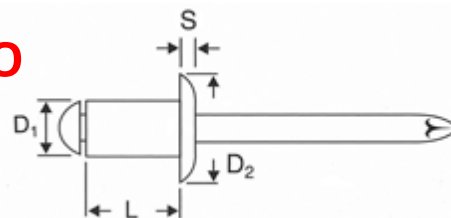

| CODIGO | BROCA Ø3.25 | MEDIDA | ESPESOR | EMBALAJE | EMBALAJE |
|--------|--------------|----------|-----------|----------|-----------|
| | D2:6.5/S:0.8 | 3.2 | | INTERIOR | EXTERIOR. |
| | REFERENCIA | D1 x L | | | |
| 22001 | 16003206 | 3.2 x 6 | 1,5-3,5 | 1.000 | 18.000 |
| 22003 | 16003208 | 3.2 x 8 | 3,5-5,5 | 1.000 | 18.000 |
| 22004 | 16003210 | 3.2 x 10 | 5,5-7,5 | 1.000 | 18.000 |
| 22005 | 16003212 | 3.2 x 12 | 7,5-9,5 | 1.000 | 18.000 |
| 22006 | 16003214 | 3.2 x 14 | 9,5-11,5 | 1.000 | 18.000 |
| 22007 | 16003216 | 3.2 x 16 | 11,5-13,5 | 1.000 | 18.000 |

| CODIGO | BROCA Ø4 | MEDIDA | ESPESOR | EMBALAJE | EMBALAJE |
|--------|------------|----------|-----------|----------|-----------|
| | D2:8.0/S:1 | 3.9 | | INTERIOR | EXTERIOR. |
| | REFERENCIA | D1 x L | | | |
| 22008 | 16003906 | 3.9 x 6 | 1,5-3,5 | 1.000 | 18.000 |
| 22009 | 16003908 | 3.9 x 8 | 3,0-5,0 | 1.000 | 18.000 |
| 22010 | 16003910 | 3.9 x 10 | 5,0-7,0 | 1.000 | 18.000 |
| 22011 | 16003912 | 3.9 x 12 | 7,0-9,0 | 500 | 9.000 |
| 22012 | 16003914 | 3.9 x 14 | 9,0-11,0 | 500 | 9.000 |
| 22069 | 16003916 | 3.9 x 16 | 11,0-13,0 | 500 | 9.000 |

| CODIGO | BROCA Ø5 | MEDIDA | ESPESOR | EMBALAJE | EMBALAJE |
|--------|--------------|----------|-----------|----------|-----------|
| | D2:9.5/S:1.1 | 4.8 | | INTERIOR | EXTERIOR. |
| | REFERENCIA | D1 x L | | | |
| 22028 | 16004808 | 4.8 x 8 | 2,5-4,5 | 500 | 9.000 |
| 22029 | 16004810 | 4.8 x 10 | 4,5-6,5 | 500 | 9.000 |
| 22030 | 16004812 | 4.8 x 12 | 6,5-8,5 | 500 | 9.000 |
| 22031 | 16004814 | 4.8 x 14 | 8,5-10,5 | 500 | 9.000 |
| 22032 | 16004816 | 4.8 x 16 | 10,5-12,5 | 500 | 9.000 |
| 22033 | 16004818 | 4,8 x 18 | 12,5-14,5 | 500 | 9.000 |
| 22034 | 16004820 | 4.8 x 20 | 14,5-16,5 | 250 | 4.500 |
| 22035 | 16004825 | 4.8 x 25 | 19,5-21,5 | 250 | 4.500 |

FAMILIA 1601 REM.ALUMINIO LC.BLANCO

FAMILIA 1602 REM.ALUMINIO LC.NEGRO

CONSULTE: COLOR –RAL Y DISPONIBILIDAD.

| COLOR | RAL | COLOR | RAL | COLOR | RAL |
|----------|------|---------|------|---------|------|
| AMARILLO | 1021 | MARRON | 8014 | BLANCO | 9010 |
| AZUL | 5010 | NARANJA | 2004 | NEGRO | 9005 |
| BRONCE | | ORO | | BURDEOS | 3004 |
| ROJO | 3000 | CREMA | 1015 | VERDE | 6002 |
| GRIS | 7035 | VERDE | 6005 | PLATA | |

CONSULTAR

FAMILIA 1700

REMACHES ALUMINIO – INOX

RIVETS ALUMINIUM - STAINLES STEEL

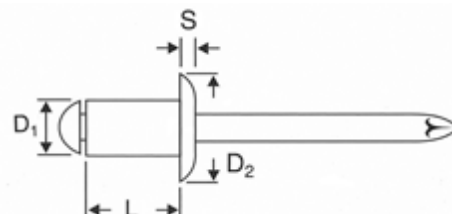

| CODIGO | BROCA Ø3.1 | MEDIDA | ESPEJOR | EMBALAJE | EMBALAJE |
|--------|--------------|--------|---------|----------|-----------|
| | D2:6.5/S:0.8 | 3 | | INTERIOR | EXTERIOR. |
| | REFERENCIA | D1 x L | | | |
| 00646 | 17003006 | 3 x 6 | 1,5-3,5 | 1.000 | 18.000 |
| 00647 | 17003008 | 3 x 8 | 3,5-5,5 | 1.000 | 18.000 |
| 00648 | 17003010 | 3 x 10 | 5,5-7,0 | 1.000 | 18.000 |
| 00649 | 17003012 | 3 x 12 | 7,5-9,0 | 1.000 | 18.000 |

| CODIGO | BROCA Ø3.25 | MEDIDA | ESPEJOR | EMBALAJE | EMBALAJE |
|--------|--------------|----------|---------|----------|-----------|
| | D2:6.5/S:0.8 | 3.2 | | INTERIOR | EXTERIOR. |
| | REFERENCIA | D1 x L | | | |
| 00650 | 17003206 | 3.2 x 6 | 1,5-3,5 | 1.000 | 18.000 |
| 00651 | 17003208 | 3.2 x 8 | 3,5-5,5 | 1.000 | 18.000 |
| 00652 | 17003210 | 3.2 x 10 | 5,5-7,0 | 1.000 | 18.000 |
| 00653 | 17003212 | 3.2 x 12 | 7,0-9,0 | 1.000 | 18.000 |

| CODIGO | BROCA Ø4 | MEDIDA | ESPEJOR | EMBALAJE | EMBALAJE |
|--------|------------|----------|---------|----------|-----------|
| | D2:8/S:1 | 3.9 | | INTERIOR | EXTERIOR. |
| | REFERENCIA | D1 x L | | | |
| 00654 | 17003906 | 3.9 x 6 | 1,5-3,5 | 1.000 | 18.000 |
| 00655 | 17003908 | 3.9 x 8 | 3,0-5,0 | 1.000 | 18.000 |
| 00656 | 17003910 | 3.9 x 10 | 5,0-7,0 | 1.000 | 18.000 |
| 00657 | 17003912 | 3.9 x 12 | 7,0-9,0 | 500 | 9.000 |

| CODIGO | BROCA Ø5 | MEDIDA | ESPEJOR | EMBALAJE | EMBALAJE |
|--------|--------------|----------|-----------|----------|-----------|
| | D2:9.5/S:1.1 | 4.8 | | INTERIOR | EXTERIOR. |
| | REFERENCIA | D1 x L | | | |
| 00658 | 17004808 | 4.8 x 8 | 2,5-4,5 | 500 | 9.000 |
| 00659 | 17004810 | 4.8 x 10 | 4,5-6,5 | 500 | 9.000 |
| 00660 | 17004812 | 4.8 x 12 | 6,5-8,5 | 500 | 9.000 |
| 00661 | 17004814 | 4.8 x 14 | 8,5-10,5 | 500 | 9.000 |
| 00662 | 17004816 | 4.8 x 16 | 10,5-12,5 | 500 | 9.000 |
| 00663 | 17004818 | 4,8 x 18 | 12,5-14,5 | 500 | 9.000 |
| 00664 | 17004820 | 4.8 x 20 | 14,5-16,5 | 250 | 4.500 |

OTRAS MEDIDAS CONSULTAR – FABRICACION BAJO PEDIDO.

FAMILIA 1701



REMACHES ALUMINIO – INOX LC.BLANCO

RIVETS ALUMINIUM - STAINLES STEEL LACQUERED

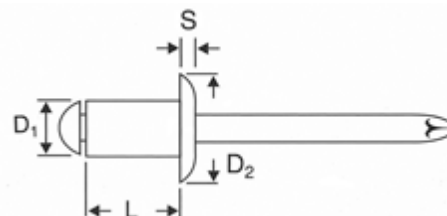

| CODIGO | BROCA $\varnothing 3.25$ | MEDIDA | ESPESOR | EMBALAJE | EMBALAJE |
|--------|--------------------------|----------|---------|----------|-----------|
| | D2:6.5/S:0.8 | 3.2 | | INTERIOR | EXTERIOR. |
| | REFERENCIA | D1 x L | | | |
| 00665 | 17013206 | 3.2 x 6 | 1,5-3,5 | 1.000 | 18.000 |
| 00666 | 17013208 | 3.2 x 8 | 3,5-5,5 | 1.000 | 18.000 |
| 00667 | 17013210 | 3.2 x 10 | 5,5-7,0 | 1.000 | 18.000 |
| 00668 | 17013212 | 3.2 x 12 | 7,0-9,0 | 1.000 | 18.000 |

| CODIGO | BROCA $\varnothing 4$ | MEDIDA | ESPESOR | EMBALAJE | EMBALAJE |
|--------|-----------------------|----------|---------|----------|-----------|
| | D2:8/S:1 | 3.9 | | INTERIOR | EXTERIOR. |
| | REFERENCIA | D1 x L | | | |
| 00669 | 17013906 | 3.9 x 6 | 1,5-3,5 | 1.000 | 18.000 |
| 00670 | 17013908 | 3.9 x 8 | 3,0-5,0 | 1.000 | 18.000 |
| 00671 | 17013910 | 3.9 x 10 | 5,0-7,0 | 1.000 | 18.000 |
| 00672 | 17013912 | 3.9 x 12 | 7,0-9,0 | 500 | 9.000 |

| CODIGO | BROCA $\varnothing 5$ | MEDIDA | ESPESOR | EMBALAJE | EMBALAJE |
|--------|-----------------------|----------|-----------|----------|-----------|
| | D2:9.5/S:1.1 | 4.8 | | INTERIOR | EXTERIOR. |
| | REFERENCIA | D1 x L | | | |
| 00673 | 17014808 | 4.8 x 8 | 2,5-4,5 | 500 | 9.000 |
| 00674 | 17014810 | 4.8 x 10 | 4,5-6,5 | 500 | 9.000 |
| 00675 | 17014812 | 4.8 x 12 | 6,5-8,5 | 500 | 9.000 |
| 00676 | 17014814 | 4.8 x 14 | 8,5-10,5 | 500 | 9.000 |
| 00677 | 17014816 | 4.8 x 16 | 10,5-12,5 | 500 | 9.000 |
| 00678 | 17014818 | 4,8 x 18 | 12,5-14,5 | 500 | 9.000 |
| 00679 | 17014820 | 4.8 x 20 | 14,5-16,5 | 250 | 4.500 |

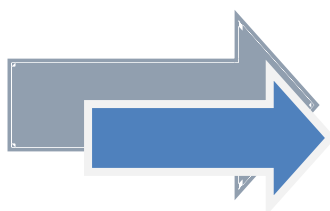

FABRICACION BAJO PEDIDO.

CONSULTAR DISPONIBILIDAD

FAMILIA 1702



REMACHES ALUMINIO – INOX LC.NEGRO

RIVETS ALUMINIUM - STAINLES STEEL LACQUERED

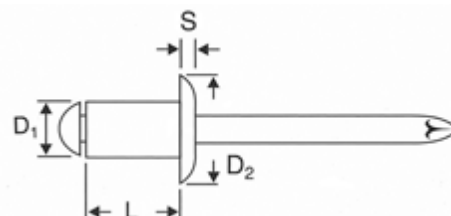

| CODIGO | BROCA Ø3.25 | MEDIDA | ESPESOR | EMBALAJE | |
|--------|--------------|----------|---------|----------|-----------|
| | D2:6.5/S:0.8 | 3.2 | | INTERIOR | EXTERIOR. |
| | REFERENCIA | D1 x L | | | |
| 00680 | 17013206 | 3.2 x 6 | 1,5-3,5 | 1.000 | 18.000 |
| 00681 | 17013208 | 3.2 x 8 | 3,5-5,5 | 1.000 | 18.000 |
| 00682 | 17013210 | 3.2 x 10 | 5,5-7,0 | 1.000 | 18.000 |
| 00683 | 17013212 | 3.2 x 12 | 7,0-9,0 | 1.000 | 18.000 |

| CODIGO | BROCA Ø4 | MEDIDA | ESPESOR | EMBALAJE | |
|--------|------------|----------|---------|----------|-----------|
| | D2:8/S:1 | 3.9 | | INTERIOR | EXTERIOR. |
| | REFERENCIA | D1 x L | | | |
| 00684 | 17013906 | 3.9 x 6 | 1,5-3,5 | 1.000 | 18.000 |
| 00685 | 17013908 | 3.9 x 8 | 3,0-5,0 | 1.000 | 18.000 |
| 00686 | 17013910 | 3.9 x 10 | 5,0-7,0 | 1.000 | 18.000 |
| 00687 | 17013912 | 3.9 x 12 | 7,0-9,0 | 500 | 9.000 |

| CODIGO | BROCA Ø5 | MEDIDA | ESPESOR | EMBALAJE | |
|--------|--------------|----------|-----------|----------|-----------|
| | D2:9.5/S:1.1 | 4.8 | | INTERIOR | EXTERIOR. |
| | REFERENCIA | D1 x L | | | |
| 00688 | 17014808 | 4.8 x 8 | 2,5-4,5 | 500 | 9.000 |
| 00689 | 17014810 | 4.8 x 10 | 4,5-6,5 | 500 | 9.000 |
| 00690 | 17014812 | 4.8 x 12 | 6,5-8,5 | 500 | 9.000 |
| 00691 | 17014814 | 4.8 x 14 | 8,5-10,5 | 500 | 9.000 |
| 00692 | 17014816 | 4.8 x 16 | 10,5-12,5 | 500 | 9.000 |
| 00693 | 17014818 | 4,8 x 18 | 12,5-14,5 | 500 | 9.000 |
| 00694 | 17014820 | 4.8 x 20 | 14,5-16,5 | 250 | 4.500 |

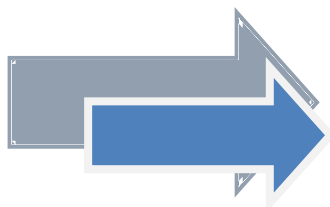

FABRICACION BAJO PEDIDO.

CONSULTE: COLOR -RAL Y DISPONIBILIDAD.

| COLOR | RAL | COLOR | RAL | COLOR | RAL |
|----------|------|---------|------|---------|------|
| AMARILLO | 1021 | MARRON | 8014 | BLANCO | 9010 |
| AZUL | 5010 | NARANJA | 2004 | NEGRO | 9005 |
| BRONCE | | ORO | | BURDEOS | 3004 |
| ROJO | 3000 | CREMA | 1015 | VERDE | 6002 |
| GRIS | 7035 | VERDE | 6005 | PLATA | |

FAMILIA 1710

REMACHES ALUMINIO – INOX ALA ANCHA

RIVETS ALUMINIUM - STAINLES STEEL LARGE HEAD

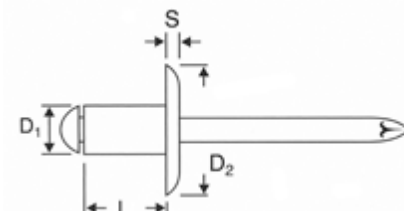

| CODIGO | BROCA Ø4.1 | MEDIDA 4 | ESPESOR | EMBALAJE | |
|--------|-------------|-------------|---------|------------|----------|
| | D2:10/S:1.3 | | | REFERENCIA | INTERIOR |
| 00695 | 17103906 | 3.9 x 6 | 1,5-3,5 | 1.000 | 18.000 |
| 00696 | 17103908 | 3.9 x 8 | 3,0-5,0 | 1.000 | 18.000 |
| 00697 | 17103910 | 3.9 x 10 | 5,0-7,0 | 1.000 | 18.000 |
| 00698 | 17103912 | 3.9 x 12 | 7,0-9,0 | 500 | 9.000 |

| CODIGO | BROCA Ø5 | MEDIDA 4.9 | ESPESOR | EMBALAJE | |
|--------|-------------|---------------|-----------|------------|----------|
| | D2:14/S:1.6 | | | REFERENCIA | INTERIOR |
| 00699 | 17104808 | 4.9 x 8 | 2,5-4,5 | 500 | 9.000 |
| 00700 | 17104810 | 4.9 x 10 | 4,5-6,5 | 500 | 9.000 |
| 00701 | 17104812 | 4.9 x 12 | 6,5-8,5 | 500 | 9.000 |
| 00702 | 17104814 | 4.9 x 14 | 8,5-10,5 | 500 | 9.000 |
| 00703 | 17104816 | 4.9 x 16 | 10,5-12,5 | 500 | 9.000 |
| 00704 | 17104818 | 4.9 x 18 | 12,5-14,5 | 500 | 9.000 |
| 00705 | 17104820 | 4.9 x 20 | 14,5-16,5 | 250 | 4.500 |



FABRICACION BAJO PEDIDO

CONSULTAR DISPONIBILIDAD

FAMILIA 1711

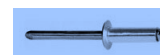

REMACHES ALUMINIO – INOX ALA ANCHA LC.BLANCO

RIVETS ALUMINIUM STAINLES STEEL LARGE HEAD LACQUERED

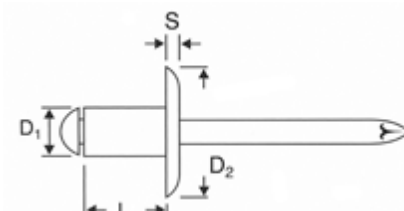

| CODIGO | BROCA Ø4.1 D2:10/S:1.3 REFERENCIA | MEDIDA 4 D1 x L | ESPESOR | EMBALAJE | |
|--------|---|-----------------------|---------|----------|-----------|
| | | | | INTERIOR | EXTERIOR. |
| 00706 | 17113906 | 3.9 x 6 | 1,5-3,5 | 1.000 | 18.000 |
| 00707 | 17113908 | 3.9 x 8 | 3,0-5,0 | 1.000 | 18.000 |
| 00708 | 17113910 | 3.9 x 10 | 5,0-7,0 | 1.000 | 18.000 |
| 00709 | 17113912 | 3.9 x 12 | 7,0-9,0 | 500 | 9.000 |

| CODIGO | BROCA Ø5 D2:14/S:1.6 REFERENCIA | MEDIDA 4.9 D1 x L | ESPESOR | EMBALAJE | |
|--------|---------------------------------------|-------------------------|-----------|----------|-----------|
| | | | | INTERIOR | EXTERIOR. |
| 00710 | 17114808 | 4.8 x 8 | 2,5-4,5 | 500 | 9.000 |
| 00711 | 17114810 | 4.8 x 10 | 4,5-6,5 | 500 | 9.000 |
| 00712 | 17114812 | 4.8 x 12 | 6,5-8,5 | 500 | 9.000 |
| 00713 | 17114814 | 4.8 x 14 | 8,5-10,5 | 500 | 9.000 |
| 00714 | 17114816 | 4.8 x 16 | 10,5-12,5 | 500 | 9.000 |
| 00715 | 17114818 | 4,8 x 18 | 12,5-14,5 | 500 | 9.000 |
| 00716 | 17114820 | 4.8 x 20 | 14,5-16,5 | 250 | 4.500 |

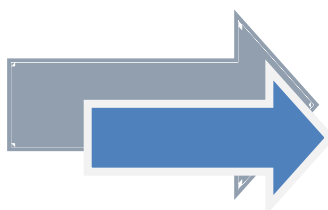

FABRICACION BAJO PEDIDO

CONSULTE: COLOR –RAL Y DISPONIBILIDAD.

| COLOR | RAL | COLOR | RAL | COLOR | RAL |
|----------|------|---------|------|---------|------|
| AMARILLO | 1021 | MARRON | 8014 | BLANCO | 9010 |
| AZUL | 5010 | NARANJA | 2004 | NEGRO | 9005 |
| BRONCE | | ORO | | BURDEOS | 3004 |
| ROJO | 3000 | CREMA | 1015 | VERDE | 6002 |
| GRIS | 7035 | VERDE | 6005 | PLATA | |

FAMILIA 1712



REMACHES ALUMINIO – INOX ALA ANCHA LC.NEGRO

RIVETS ALUMINIUM - STAINLES STEEL LARGE HEAD LACQUERED

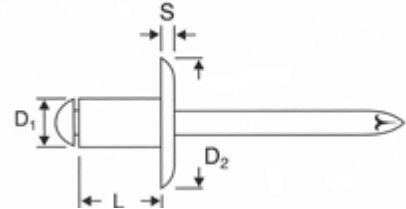

| CODIGO | BROCA Ø4.1 D2:10/S:1.3 REFERENCIA | MEDIDA 4 D1 x L | ESPESOR | EMBALAJE | |
|--------|---|-----------------------|---------|----------|-----------|
| | | | | INTERIOR | EXTERIOR. |
| 00717 | 17123906 | 3.9 x 6 | 1,5-3,5 | 1.000 | 18.000 |
| 00718 | 17123908 | 3.9 x 8 | 3,0-5,0 | 1.000 | 18.000 |
| 00719 | 17123910 | 3.9 x 10 | 5,0-7,0 | 1.000 | 18.000 |
| 00720 | 17123912 | 3.9 x 12 | 7,0-9,0 | 500 | 9.000 |

| CODIGO | BROCA Ø5 D2:14/S:1.6 REFERENCIA | MEDIDA 4.9 D1 x L | ESPESOR | EMBALAJE | |
|--------|---------------------------------------|-------------------------|-----------|----------|-----------|
| | | | | INTERIOR | EXTERIOR. |
| 00721 | 17124808 | 4.9 x 8 | 2,5-4,5 | 500 | 9.000 |
| 00722 | 17124810 | 4.9 x 10 | 4,5-6,5 | 500 | 9.000 |
| 00723 | 17124812 | 4.9 x 12 | 6,5-8,5 | 500 | 9.000 |
| 00724 | 17124814 | 4.9 x 14 | 8,5-10,5 | 500 | 9.000 |
| 00725 | 17124816 | 4.9 x 16 | 10,5-12,5 | 500 | 9.000 |
| 00726 | 17124818 | 4,9 x 18 | 12,5-14,5 | 500 | 9.000 |
| 00727 | 17124820 | 4.9 x 20 | 14,5-16,5 | 250 | 4.500 |

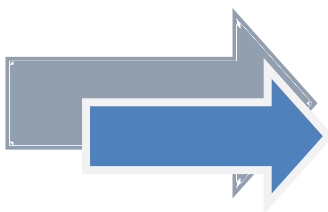

FABRICACION BAJO PEDIDO.

CONSULTE: COLOR –RAL Y DISPONIBILIDAD.

| COLOR | RAL | COLOR | RAL | COLOR | RAL |
|----------|------|---------|------|---------|------|
| AMARILLO | 1021 | MARRON | 8014 | BLANCO | 9010 |
| AZUL | 5010 | NARANJA | 2004 | NEGRO | 9005 |
| BRONCE | | ORO | | BURDEOS | 3004 |
| ROJO | 3000 | CREMA | 1015 | VERDE | 6002 |
| GRIS | 7035 | VERDE | 6005 | PLATA | |

FAMILIA 1720

REMACHES ALUMINIO – INOX ALA SUPER ANCHA

RIVETS ALUMINIUM - STAINLES STEEL EXTRA LARGE HEAD

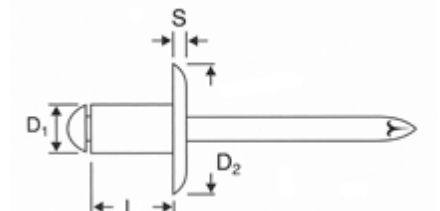

| CODIGO | BROCA Ø5 D2:16/S:1,5 REFERENCIA | MEDIDA 5 D1 x L | ESPESOR | EMBALAJE | |
|--------|---------------------------------------|-----------------------|-----------|----------|----------|
| | | | | INTERIOR | EXTERIOR |
| 00728 | 17204808 | 4.9 x 8 | 2,5-4,5 | 500 | 9.000 |
| 00729 | 17204810 | 4.9 x 10 | 4,5-6,5 | 500 | 9.000 |
| 00730 | 17204812 | 4.9 x 12 | 6,5-8,5 | 500 | 9.000 |
| 00731 | 17204814 | 4.9 x 14 | 8,5-10,5 | 500 | 9.000 |
| 00732 | 17204816 | 4.9 x 16 | 10,5-12,5 | 500 | 9.000 |
| 00733 | 17204818 | 4.9 x 18 | 12,5-14,5 | 500 | 9.000 |
| 00734 | 17204820 | 4.8 x 20 | 14,5-16,5 | 250 | 4.500 |

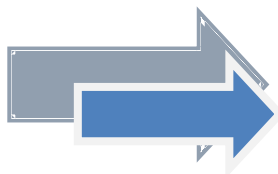

**FABRICACION BAJO PEDIDO.
CONSULTAR DISPONIBILIDAD**

FAMILIA 1721



REMACHES ALUMINIO – INOX ALA SUPER ANCHA LC.BLANCO

RIVETS ALUMINIUM STAINLES STEEL EXTRA LARGE HEAD LACQUERED

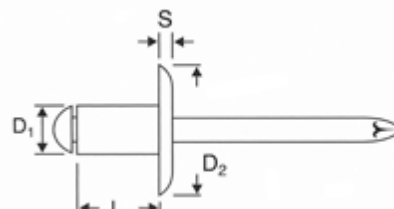

| CODIGO | BROCA Ø5 D2:16/S:1,5 REFERENCIA | MEDIDA 5 D1 x L | ESPESOR | EMBALAJE | |
|--------|---------------------------------------|-----------------------|-----------|----------|----------|
| | | | | INTERIOR | EXTERIOR |
| 00735 | 17214808 | 4.8 x 8 | 2,5-4,5 | 500 | 9.000 |
| 00736 | 17214810 | 4.8 x 10 | 4,5-6,5 | 500 | 9.000 |
| 00737 | 17214812 | 4.8 x 12 | 6,5-8,5 | 500 | 9.000 |
| 00738 | 17214814 | 4.8 x 14 | 8,5-10,5 | 500 | 9.000 |
| 00739 | 17214816 | 4.8 x 16 | 10,5-12,5 | 500 | 9.000 |
| 00740 | 17214818 | 4,8 x 18 | 12,5-14,5 | 500 | 9.000 |
| 00741 | 17214820 | 4.8 x 20 | 14,5-16,5 | 250 | 4.500 |

FAMILIA 1722

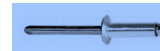

REMACHES ALUMINIO – INOX ALA SUPER ANCHA LC.NEGRO

RIVETS ALUMINIUM STAINLES STEEL EXTRA LARGE HEAD LACQUERED

| CODIGO | BROCA Ø5 D2:16/S:1,5 REFERENCIA | MEDIDA 5 D1 x L | ESPESOR | EMBALAJE | |
|--------|---------------------------------------|-----------------------|-----------|----------|----------|
| | | | | INTERIOR | EXTERIOR |
| 00742 | 17224808 | 4.9 x 8 | 2,5-4,5 | 500 | 9.000 |
| 00743 | 17224810 | 4.9 x 10 | 4,5-6,5 | 500 | 9.000 |
| 00744 | 17224812 | 4.9 x 12 | 6,5-8,5 | 500 | 9.000 |
| 00745 | 17224814 | 4.9 x 14 | 8,5-10,5 | 500 | 9.000 |
| 00746 | 17224816 | 4.9 x 16 | 10,5-12,5 | 500 | 9.000 |
| 00747 | 17224818 | 4.9 x 18 | 12,5-14,5 | 500 | 9.000 |
| 00748 | 17224820 | 4.9 x 20 | 14,5-16,5 | 250 | 4.500 |

FABRICACION BAJO PEDIDO.

CONSULTE: COLOR –RAL Y DISPONIBILIDAD.

| COLOR | RAL | COLOR | RAL | COLOR | RAL |
|----------|------|---------|------|---------|------|
| AMARILLO | 1021 | MARRON | 8014 | BLANCO | 9010 |
| AZUL | 5010 | NARANJA | 2004 | NEGRO | 9005 |
| BRONCE | | ORO | | BURDEOS | 3004 |
| ROJO | 3000 | CREMA | 1015 | VERDE | 6002 |
| GRIS | 7035 | VERDE | 6005 | PLATA | |

FAMILIA 1800

REMACHES ESTANCO (ALU-ACE)

RIVET SEALED DOME HEAD

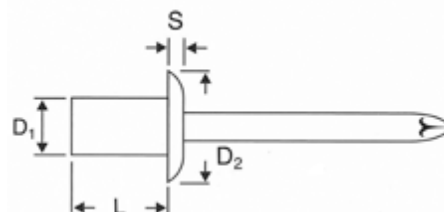

| CODIGO | BROCA Ø3.3 D2:6 /S:1.4 REFERENCIA | MEDIDA 3.2 D1 x L | ESPESOR | EMBALAJE | |
|--------|---|-------------------------|---------|----------|----------|
| | | | | INTERIOR | EXTERIOR |
| 80001 | 18003206 | 3.2 x 6 | 0,5-2,0 | 1.000 | 18.000 |
| 80002 | 18003208 | 3.2 x 8 | 2,0-3,5 | 1.000 | 18.000 |
| 80004 | 18003209 | 3.2 x 9 | 3,5-5,0 | 1.000 | 18.000 |
| 80005 | 18003211 | 3.2 x 11 | 5,0-6,5 | 1.000 | 18.000 |
| 80006 | 18003213 | 3.2 x 13 | 6,5-8,0 | 1.000 | 18.000 |

| CODIGO | BROCA Ø4 D2:8 /S:1.7 REFERENCIA | MEDIDA 3.9 D1 x L | ESPESOR | EMBALAJE | |
|--------|---------------------------------------|-------------------------|----------|----------|----------|
| | | | | INTERIOR | EXTERIOR |
| 80009 | 18003908 | 3.9 x 8 | 0,5-3,5 | 1.000 | 18.000 |
| 80010 | 18003910 | 3.9 x 10 | 3,5-4,5 | 1.000 | 18.000 |
| 80015 | 18003911 | 3.9 x 11 | 4,5-6,5 | 1.000 | 18.000 |
| 80011 | 18003913 | 3.9 x 13 | 6,5-8,0 | 500 | 9.000 |
| 80012 | 18003915 | 3.9 x 15 | 8,0-10,5 | 500 | 9.000 |

| CODIGO | BROCA Ø5 D2:9.5 /S:2.0 REFERENCIA | MEDIDA 4.8 D1 x L | ESPESOR | EMBALAJE | |
|--------|---|-------------------------|-----------|----------|----------|
| | | | | INTERIOR | EXTERIOR |
| 80028 | 18004808 | 4.8 x 8 | 1,0-3,0 | 500 | 9.000 |
| 80029 | 18004895 | 4.8 x 9.5 | 3,0-4,5 | 500 | 9.000 |
| 00749 | 18004811 | 4.8 x 11 | 4,5-6,0 | 500 | 9.000 |
| 80030 | 18004812 | 4.8 x 12.5 | 6,0-7,5 | 500 | 9.000 |
| 80031 | 18004814 | 4.8 x 14 | 7,5-9,0 | 500 | 9.000 |
| 00750 | 18004816 | 4.8 x 16 | 9,0-11,0 | 500 | 9.000 |
| 80033 | 18004818 | 4,8 x 18 | 11,0-13,0 | 500 | 9.000 |
| 80034 | 18004821 | 4.8 x 21 | 13,0-16,0 | 250 | 4.500 |
| 80036 | 18004824 | 4.8 x 24 | 16,0-20,0 | 250 | 4.500 |

| CODIGO | BROCA Ø6.5 D2:12.7 /S:2.5 REFERENCIA | MEDIDA 6.4 D1 x L | ESPESOR | EMBALAJE | |
|--------|--|-------------------------|---------|----------|----------|
| | | | | INTERIOR | EXTERIOR |
| 80016 | 18006412 | 6,4 x 12 | 1,5-6,0 | 250 | 4.500 |
| 80017 | 18006416 | 6,4 x 16 | 6,0-8,0 | 250 | 4.500 |

FAMILIA 1830

REMACHES ESTANCO CAB.AVELLANADA (ALU-ACE)

RIVET SEALED COUNTERSUNK HEAD

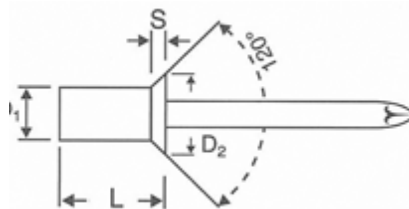

| CODIGO | BROCA Ø 3.3 | MEDIDA | ESPESOR | EMBALAJE | |
|--------|--------------|------------|----------|----------|----------|
| | D2: 6 /S:1.4 | 3.2 | | INTERIOR | EXTERIOR |
| | REFERENCIA | D1 x L | | | |
| 00751 | 18303275 | 3.2 x 7.5 | 12,5-3,5 | 1.000 | 18.000 |
| 00752 | 18303295 | 3.2 x 9.5 | 3,0-4,5 | 1.000 | 18.000 |
| 00753 | 18303210 | 3.2 x 10.5 | 4,5-6,0 | 1.000 | 18.000 |
| 00754 | 18303212 | 3.2 x 12 | 6,0-7,5 | 1.000 | 18.000 |
| 00755 | 18303213 | 3.2 x 13.5 | 7,5-9,0 | 1.000 | 18.000 |

| CODIGO | BROCA Ø 4.1 | MEDIDA | ESPESOR | EMBALAJE | |
|--------|--------------|----------|---------|----------|----------|
| | D2: 8 /S:1.7 | 3.9 | | INTERIOR | EXTERIOR |
| | REFERENCIA | D1 x L | | | |
| 00756 | 18304095 | 4 x 9.5 | 3,0-5,0 | 1.000 | 18.000 |
| 00757 | 18304011 | 4 x 11 | 5,0-6,5 | 1.000 | 18.000 |
| 00758 | 18304012 | 4 x 12.5 | 6,5-8,0 | 1.000 | 18.000 |
| 00759 | 18304014 | 4 x 14 | 8,0-9,5 | 500 | 9.000 |

| CODIGO | BROCA Ø 4.9 | MEDIDA | ESPESOR | EMBALAJE | |
|--------|-------------|------------|-----------|----------|----------|
| | D2:9.5 /S:2 | 4.8 | | INTERIOR | EXTERIOR |
| | REFERENCIA | D1 x L | | | |
| 00760 | 18304895 | 4.8 x 9.5 | 3,0-5,0 | 500 | 9.000 |
| 00761 | 18304811 | 4.8 x 11 | 5,0-6,5 | 500 | 9.000 |
| 00762 | 18304812 | 4.8 x 12.5 | 6,0-7,5 | 500 | 9.000 |
| 00763 | 18304814 | 4.8 x 14 | 7,5-9,0 | 500 | 9.000 |
| 00764 | 18304815 | 4.8 x 15.5 | 9,0-10,5 | 500 | 9.000 |
| 00765 | 18304819 | 4,8 x 19.5 | 12,0-14,0 | 500 | 9.000 |

FAMILIA 1860

REMACHES ESTANCO (ALU-ALU)

RIVET SEALED ALUM/ALUM

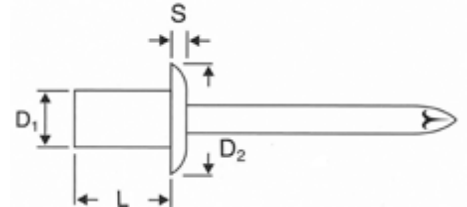

| CODIGO | BROCA Ø 3.3 | MEDIDA | ESPESOR | EMBALAJE | EMBALAJE |
|--------|--------------|-----------|---------|----------|----------|
| | D2: 6 /S:1.4 | 3.2 | | INTERIOR | EXTERIOR |
| | REFERENCIA | D1 x L | | | |
| 00766 | 18603208 | 3.2 x 8 | 0,5-3,5 | 1.000 | 18.000 |
| 00767 | 18603295 | 3.2 x 9.5 | 3,5-5,5 | 1.000 | 18.000 |

| CODIGO | BROCA Ø 4.1 | MEDIDA | ESPESOR | EMBALAJE | EMBALAJE |
|--------|--------------|----------|---------|----------|----------|
| | D2: 8 /S:1.7 | 3.9 | | INTERIOR | EXTERIOR |
| | REFERENCIA | D1 x L | | | |
| 00768 | 18604095 | 4 x 9.5 | 1,0-5,0 | 1.000 | 18.000 |
| 00769 | 18304012 | 4 x 12.5 | 6,5-8,0 | 1.000 | 18.000 |

| CODIGO | BROCA Ø 4.9 | MEDIDA | ESPESOR | EMBALAJE | EMBALAJE |
|--------|-------------|------------|----------|----------|----------|
| | D2:9.5 /S:2 | 4.8 | | INTERIOR | EXTERIOR |
| | REFERENCIA | D1 x L | | | |
| 00770 | 18604895 | 4.8 x 9.5 | 2,5-5,0 | 500 | 9.000 |
| 00771 | 18604811 | 4.8 x 11.5 | 4,0-7,0 | 500 | 9.000 |
| 00772 | 18604814 | 4.8 x 14.5 | 8,0-9,5 | 500 | 9.000 |
| 00773 | 18604818 | 4,8 x 18 | 9,5-13,5 | 500 | 9.000 |

FAMILIA 1870

REMACHES ESTANCO (ALU-INOX)

RIVET SEALED ALUM/STAINLES STEEL

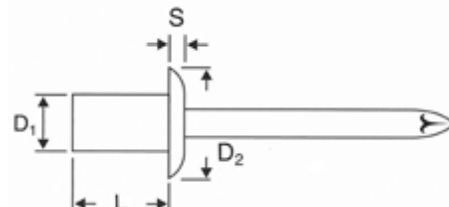

| CODIGO | BROCA Ø 3.3 | MEDIDA 3.2 D1 x L | ESPESOR | EMBALAJE | |
|--------|-----------------------------|-------------------------|---------|----------|----------|
| | D2: 6 /S: 1.4 REFERENCIA | | | INTERIOR | EXTERIOR |
| 00774 | 18703206 | 3.2 x 6 | 0,5-2,0 | 1.000 | 18.000 |
| 00775 | 18703208 | 3.2 x 8 | 2,0-3,5 | 1.000 | 18.000 |
| 00776 | 18703295 | 3.2 x 9.5 | 3,5-5,0 | 1.000 | 18.000 |
| 00777 | 18703211 | 3.2 x 11 | 5,0-6,5 | 1.000 | 18.000 |
| 00778 | 18703213 | 3.2 x 12.7 | 6,5-8,0 | 1.000 | 18.000 |

| CODIGO | BROCA Ø 4.1 | MEDIDA 3.9 D1 x L | ESPESOR | EMBALAJE | |
|--------|---------------------------|-------------------------|---------|----------|----------|
| | D2:8 /S:1.7 REFERENCIA | | | INTERIOR | EXTERIOR |
| 00779 | 18704008 | 4 x 8 | 0,5-3,5 | 1.000 | 18.000 |
| 00780 | 18704095 | 4 x 9.5 | 3,5-4,5 | 1.000 | 18.000 |
| 00781 | 18704011 | 4 x 11 | 4,5-6,5 | 1.000 | 18.000 |
| 00782 | 18704013 | 4 x 12.7 | 6,5-8,0 | 500 | 9.000 |

| CODIGO | BROCA Ø 4.9 | MEDIDA 4.8 D1 x L | ESPESOR | EMBALAJE | |
|--------|-----------------------------|-------------------------|-----------|----------|----------|
| | D2: 9.5 /S: 2 REFERENCIA | | | INTERIOR | EXTERIOR |
| 00783 | 18704808 | 4.8 x 8 | 1,0-3,0 | 500 | 9.000 |
| 00784 | 18704895 | 4.8 x 9.5 | 3,0-4,5 | 500 | 9.000 |
| 00785 | 18704811 | 4.8 x 11 | 4,5-6,0 | 500 | 9.000 |
| 00786 | 18704812 | 4.8 x 12.5 | 6,0-7,5 | 500 | 9.000 |
| 00787 | 18704814 | 4.8 x 14 | 7,5-9,0 | 500 | 9.000 |
| 00788 | 18704816 | 4.8 x 16 | 9,0-11,0 | 500 | 9.000 |
| 00789 | 18704818 | 4.8 x 18 | 11,0-13,0 | 500 | 9.000 |
| 00790 | 18704821 | 4.8 x 21 | 13,0-16,0 | 250 | 4.500 |

FAMILIA 1873

REMACHES ESTANCO CAB.AVELLANADA (ALU-INOX)

RIVET SEALED ALUM/STAINLES STEEL COUNTERSUNK HEAD

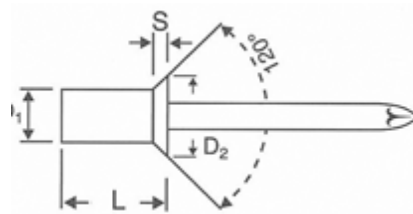

| CODIGO | BROCA Ø 3.3 | MEDIDA | ESPEJOR | EMBALAJE | EMBALAJE |
|--------|------------------------|---------------|---------|----------|----------|
| | D2:6 /S: REFERENCIA | 3.2 D1 x L | | INTERIOR | EXTERIOR |
| 00791 | 18733209 | 3.2 x 9 | 0,5-2,0 | 1.000 | 18.000 |

| CODIGO | BROCA Ø 4.1 | MEDIDA | ESPEJOR | EMBALAJE | EMBALAJE |
|--------|--------------------------|---------------|---------|----------|----------|
| | D2:7.9 /S: REFERENCIA | 3.9 D1 x L | | INTERIOR | EXTERIOR |
| 00792 | 18734095 | 4 x 9.5 | 3,5-4,5 | 1.000 | 18.000 |
| 00793 | 18734011 | 4 x 11 | 4,5-6,5 | 1.000 | 18.000 |

| CODIGO | BROCA Ø4.9 | MEDIDA | ESPEJOR | EMBALAJE | EMBALAJE |
|--------|--------------------------|---------------|-----------|----------|----------|
| | D2:9.5 /S: REFERENCIA | 4.8 D1 x L | | INTERIOR | EXTERIOR |
| 00794 | 18734811 | 4.8 x 11 | 4,5-6,0 | 500 | 9.000 |
| 00795 | 18734814 | 4.8 x 14 | 7,5-9,0 | 500 | 9.000 |
| 00796 | 18734818 | 4,8 x 18 | 11,0-13,0 | 500 | 9.000 |

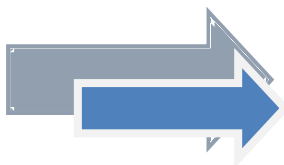

CONSULTAR DISPONIBILIDAD

FAMILIA 1840

REMACHES ESTANCO ACERO

RIVET SEALED STEEL

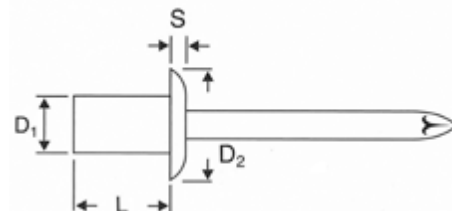

| CODIGO | BROCA \varnothing 3.3 | MEDIDA 3.2 D1 x L | ESPEJOR | EMBALAJE | |
|--------|---------------------------|-------------------------|---------|----------|----------|
| | D2:6 /S:1.4 REFERENCIA | | | INTERIOR | EXTERIOR |
| 00797 | 18403206 | 3.2 x 6 | 0,5-2,0 | 1.000 | 18.000 |
| 00798 | 18403208 | 3.2 x 8 | 2,0-3,5 | 1.000 | 18.000 |
| 00799 | 18403295 | 3.2 x 9.5 | 3,5-5,0 | 1.000 | 18.000 |
| 00800 | 18403211 | 3.2 x 12 | 5,0-6,5 | 1.000 | 18.000 |

| CODIGO | BROCA \varnothing 4.1 | MEDIDA 3.9 D1 x L | ESPEJOR | EMBALAJE | |
|--------|----------------------------|-------------------------|----------|----------|----------|
| | D2: 8 /S:1.4 REFERENCIA | | | INTERIOR | EXTERIOR |
| 00801 | 18404006 | 4 x 6 | 0,5-1,5 | 1.000 | 18.000 |
| 00802 | 18404008 | 4 x 8 | 0,5-3,5 | 1.000 | 18.000 |
| 00803 | 18704095 | 4 x 10 | 3,5-4,5 | 1.000 | 18.000 |
| 00804 | 18404012 | 4 x 12 | 5,0-6,5 | 1.000 | 18.000 |
| 00805 | 18404015 | 4 x 15 | 6,5-10,5 | 500 | 9.000 |

| CODIGO | BROCA \varnothing 4.9 | MEDIDA 4.8 D1 x L | ESPEJOR | EMBALAJE | |
|--------|------------------------------|-------------------------|----------|----------|----------|
| | D2: 9.5 /S:1.7 REFERENCIA | | | INTERIOR | EXTERIOR |
| 00806 | 18404808 | 4.8 x 8 | 1,0-3,0 | 500 | 9.000 |
| 00807 | 18404895 | 4.8 x 9.5 | 3,0-4,5 | 500 | 9.000 |
| 00808 | 18404812 | 4.8 x 12 | 6,0-7,5 | 500 | 9.000 |
| 00809 | 18704816 | 4.8 x 16 | 9,0-11,0 | 500 | 9.000 |

FAMILIA 1850

REMACHES ESTANCO INOX

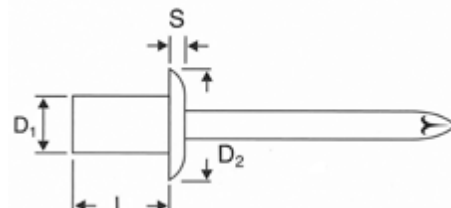

RIVET SEALED STAINLES STEEL

| CODIGO | BROCA \varnothing 3.3 | MEDIDA | ESPEJOR | EMBALAJE | |
|--------|-------------------------|-----------|---------|----------|----------|
| | D2: 6 / S: 0.9 | 3.2 | | INTERIOR | EXTERIOR |
| | REFERENCIA | D1 x L | | | |
| 00810 | 18503206 | 3.2 x 6 | 0,5-2,0 | 1.000 | 18.000 |
| 00811 | 18503208 | 3.2 x 8 | 2,0-3,5 | 1.000 | 18.000 |
| 00812 | 18503295 | 3.2 x 9.5 | 3,5-5,0 | 1.000 | 18.000 |
| 00813 | 18503211 | 3.2 x 12 | 5,0-6,5 | 1.000 | 18.000 |

| CODIGO | BROCA \varnothing 4.1 | MEDIDA | ESPEJOR | EMBALAJE | |
|--------|-------------------------|--------|----------|----------|----------|
| | D2: 8 / S: 1.3 | 3.9 | | INTERIOR | EXTERIOR |
| | REFERENCIA | D1 x L | | | |
| 00814 | 18504006 | 4 x 6 | 0,5-1,5 | 1.000 | 18.000 |
| 00815 | 18504008 | 4 x 8 | 0,5-3,5 | 1.000 | 18.000 |
| 00816 | 18504095 | 4 x 10 | 3,5-4,5 | 1.000 | 18.000 |
| 00817 | 18504012 | 4 x 12 | 5,0-6,5 | 1.000 | 18.000 |
| 00818 | 18504016 | 4 x 16 | 8,0-11,0 | 500 | 9.000 |

| CODIGO | BROCA \varnothing 4.9 | MEDIDA | ESPEJOR | EMBALAJE | |
|--------|-------------------------|-----------|----------|----------|----------|
| | D2: 9.3 / S: 2.0 | 4.8 | | INTERIOR | EXTERIOR |
| | REFERENCIA | D1 x L | | | |
| 00819 | 18504808 | 4.8 x 8 | 1,0-3,0 | 500 | 9.000 |
| 00820 | 18504895 | 4.8 x 9.5 | 3,0-4,5 | 500 | 9.000 |
| 00821 | 18504812 | 4.8 x 12 | 6,0-7,5 | 500 | 9.000 |
| 00822 | 18504816 | 4.8 x 16 | 6,5-9,0 | 500 | 9.000 |
| 00823 | 18504820 | 4.8 x 20 | 9,0-12,0 | 250 | 4.500 |

FAMILIA 1860

REMACHES ESTANCO COBRE- ACERO

RIVET SEALED COOPER / STEEL

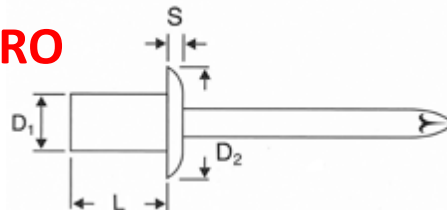

| CODIGO | BROCA \varnothing 3.3 | MEDIDA | ESPESOR | EMBALAJE | |
|--------|-------------------------|------------|---------|----------|----------|
| | D2: 6 /S:1.4 | 3.2 | | INTERIOR | EXTERIOR |
| | REFERENCIA | D1 x L | | | |
| 00824 | 18603206 | 3.2 x 6 | 0,5-2,0 | 1.000 | 18.000 |
| 00825 | 18603208 | 3.2 x 8 | 2,0-3,5 | 1.000 | 18.000 |
| 00826 | 18603295 | 3.2 x 9.5 | 3,5-5,0 | 1.000 | 18.000 |
| 00827 | 18603213 | 3.2 x 12.5 | 5,0-6,5 | 1.000 | 18.000 |

| CODIGO | BROCA \varnothing 4.1 | MEDIDA | ESPESOR | EMBALAJE | |
|--------|-------------------------|--------|---------|----------|----------|
| | D2:8 /S:1.7 | 3.9 | | INTERIOR | EXTERIOR |
| | REFERENCIA | D1 x L | | | |
| 00828 | 18604008 | 4 x 8 | 0,5-3,5 | 1.000 | 18.000 |
| 00829 | 18604095 | 4 x 10 | 3,5-4,5 | 1.000 | 18.000 |

| CODIGO | BROCA \varnothing 4.9 | MEDIDA | ESPESOR | EMBALAJE | |
|--------|-------------------------|------------|---------|----------|----------|
| | D2:9.5 /S:2 | 4.8 | | INTERIOR | EXTERIOR |
| | REFERENCIA | D1 x L | | | |
| 00830 | 18504895 | 4.8 x 9.5 | 3,0-4,5 | 500 | 9.000 |
| 00831 | 18504812 | 4.8 x 11.5 | 6,0-7,5 | 500 | 9.000 |

FAMILIA 1870

REMACHES ESTANCO COBRE- INOX

RIVET SEALED COOPER / STAINLESS STEEL

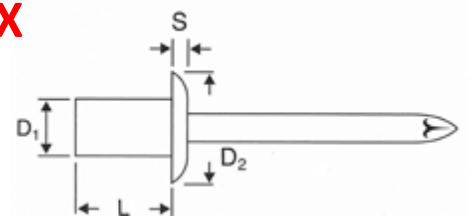

| CODIGO | BROCA \varnothing 3.3 D2: 6 /S:1.4 REFERENCIA | MEDIDA 3.2 D1 x L | ESPEJOR | EMBALAJE | |
|--------|---|-------------------------|---------|----------|----------|
| | | | | INTERIOR | EXTERIOR |
| 00832 | 18703206 | 3.2 x 6.5 | 0,5-2,0 | 1.000 | 18.000 |
| 00833 | 18703208 | 3.2 x 8 | 2,0-3,5 | 1.000 | 18.000 |
| 00834 | 18703295 | 3.2 x 9.5 | 3,5-5,0 | 1.000 | 18.000 |
| 00835 | 18703213 | 3.2 x 12.5 | 5,0-6,5 | 1.000 | 18.000 |

| CODIGO | BROCA \varnothing 4.1 D2: 8 /S:1.3 REFERENCIA | MEDIDA 3.9 D1 x L | ESPEJOR | EMBALAJE | |
|--------|---|-------------------------|---------|----------|----------|
| | | | | INTERIOR | EXTERIOR |
| 00836 | 18704008 | 4 x 8 | 0,5-3,5 | 1.000 | 18.000 |
| 00837 | 18604095 | 4 x 10 | 3,5-4,5 | 1.000 | 18.000 |

FAMILIA 1900

REMACHES COBRE – ACERO

RIVET COOPER – STEEL DOME HEAD

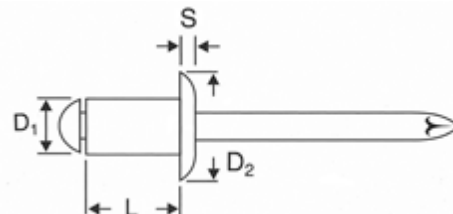

| CODIGO | BROCA Ø 3.3 | MEDIDA | ESPESOR | EMBALAJE | EMBALAJE |
|--------|---------------|----------|---------|----------|----------|
| | D2: 6 /S: 1.4 | 3.2 | | INTERIOR | EXTERIOR |
| | REFERENCIA | D1 x L | | | |
| 60001 | 19003206 | 3.2 x 6 | 1.0-3.0 | 1.000 | 18.000 |
| 60003 | 19003208 | 3.2 x 8 | 3.0-5.0 | 1.000 | 18.000 |
| 60004 | 19003210 | 3.2 x 10 | 5.0-7.0 | 1.000 | 18.000 |
| 60005 | 19003212 | 3.2 x 12 | 7.0-9.0 | 1.000 | 18.000 |

| CODIGO | BROCA Ø 4.1 | MEDIDA | ESPESOR | EMBALAJE | EMBALAJE |
|--------|--------------|--------|-----------|----------|----------|
| | D2: 8 /S:1.7 | 4 | | INTERIOR | EXTERIOR |
| | REFERENCIA | D1 x L | | | |
| 60008 | 19004006 | 4 x 6 | 1.0-2.5 | 1.000 | 18.000 |
| 60009 | 19004008 | 4 x 8 | 2.5-4.5 | 1.000 | 18.000 |
| 60010 | 19004010 | 4 x 10 | 4.5-6.5 | 500 | 9.000 |
| 60011 | 19004012 | 4 x 12 | 6.5-8.5 | 500 | 9.000 |
| 60069 | 19004016 | 4 x 16 | 10.5-12.5 | 500 | 9.000 |

| CODIGO | BROCA Ø 4.9 | MEDIDA | ESPESOR | EMBALAJE | EMBALAJE |
|--------|----------------|----------|-----------|----------|----------|
| | D2: 9.5 /S:2.0 | 4.8 | | INTERIOR | EXTERIOR |
| | REFERENCIA | D1 x L | | | |
| 60028 | 19004808 | 4.8 x 8 | 1.5-3.5 | 500 | 9.000 |
| 60029 | 19004810 | 4.8 x 10 | 3.5-5.5 | 500 | 9.000 |
| 60030 | 19004812 | 4.8 x 12 | 5.5-7.5 | 500 | 9.000 |
| 60031 | 19004814 | 4.8 x 14 | 7.5-9.5 | 500 | 9.000 |
| 60032 | 19004816 | 4.8 x 16 | 9.5-11.5 | 500 | 9.000 |
| 60033 | 19004818 | 4.8X18 | 11,5-13,5 | 500 | 9.000 |
| 60034 | 19004820 | 4.8X20 | 13,5-15,5 | 500 | 9.000 |
| 60035 | 19004824 | 4.8X24 | 18,0-21,0 | 500 | 9.000 |
| 60037 | 19004830 | 4.8X30 | 23,5-25,0 | 500 | 9.000 |



OTRAS MEDIDAS CONSULTAR – FABRICACION BAJO PEDIDO.

FAMILIA 1910

REMACHES COBRE – BRONCE

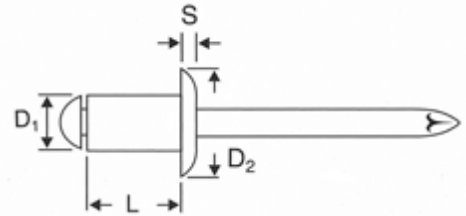

RIVET COOPER - BRONZE

| CODIGO | BROCA \varnothing 3.3 | MEDIDA 3.2 D1 x L | ESPESOR | EMBALAJE | EMBALAJE |
|--------|-------------------------|-------------------------|----------|----------|----------|
| | D2: 6.2 /S:0.8 | | | INTERIOR | EXTERIOR |
| | REFERENCIA | | | | |
| 00838 | 19103205 | 3.2 x 5 | 1.0-3.0 | 1.000 | 18.000 |
| 00839 | 19103206 | 3.2 x 6 | 3.0-5.0 | 1.000 | 18.000 |
| 00841 | 19103219 | 3.2 x 9 | 5.0-7.0 | 1.000 | 18.000 |
| 00842 | 19103210 | 3.2 x 10 | 7.0-9.0 | 1.000 | 18.000 |
| 00843 | 19103212 | 3.2 X 12 | 9.0-11.0 | 1.000 | 18.000 |

FAMILIA 1950

REMACHES COBRE – INOX

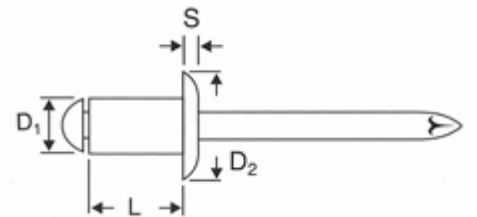

RIVET COOPER – STAINLESS STEEL

| CODIGO | BROCA \varnothing 5 | MEDIDA 3.2 D1 x L | ESPESOR | EMBALAJE | EMBALAJE |
|--------|-----------------------|-------------------------|-----------|----------|----------|
| | D2:10 /S:1.7 | | | INTERIOR | EXTERIOR |
| | REFERENCIA | | | | |
| 00939 | 19504915 | 4.9 x 45 | 35,0-40,0 | 200 | 3.600 |

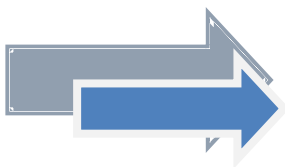

OTRAS MEDIDAS CONSULTAR – FABRICACION BAJO PEDIDO.

FAMILIA 1960

REMACHE RANURADO

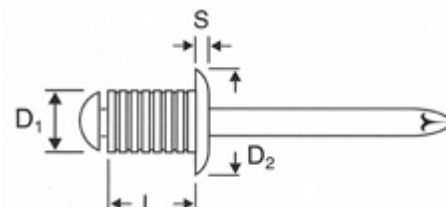

RIVET GROEVED ALU/STEEL

| CODIGO | BROCA Ø 3.3 | MEDIDA 3.2 D1 x L | ESPESOR Max. | EMBALAJE | |
|--------|------------------------------|-------------------------|-----------------|----------|----------|
| | D2: 6 / S: 1.4 REFERENCIA | | | INTERIOR | EXTERIOR |
| 22104 | 19603210 | 3.2 x 10 | 6.0 | 1.000 | 18.000 |
| 22016 | 19603214 | 3.2 x 14 | 10.0 | 1.000 | 18.000 |

| CODIGO | BROCA Ø 4 | MEDIDA 3.9 D1 x L | ESPESOR Max. | EMBALAJE | |
|--------|------------------------------|-------------------------|-----------------|----------|----------|
| | D2: 8 / S: 1.7 REFERENCIA | | | INTERIOR | EXTERIOR |
| 22109 | 19603908 | 3.9 x 8 | 4.0 | 1.000 | 18.000 |
| 22111 | 19603910 | 3.9 x 10 | 6.0 | 1.000 | 18.000 |
| 21169 | 19603912 | 3.9 x 12 | 8.0 | 1.000 | 18.000 |
| 22114 | 19603916 | 3.9 x 16 | 12.0 | 500 | 9.000 |

| CODIGO | BROCA Ø 4.9 | MEDIDA 4.8 D1 x L | ESPESOR Max. | EMBALAJE | |
|--------|------------------------------|-------------------------|-----------------|----------|----------|
| | D2: 9.5 / S: 2 REFERENCIA | | | INTERIOR | EXTERIOR |
| 22128 | 19604808 | 4.8 x 8 | 4.0 | 500 | 9.000 |
| 22130 | 19604810 | 4.8 x 10 | 6.0 | 500 | 9.000 |
| 22131 | 19604811 | 4.8 x 11 | 7.0 | 500 | 9.000 |
| 22132 | 19604812 | 4.8 x 12 | 8.0 | 500 | 9.000 |
| 21333 | 19604814 | 4.8 x 14 | 10.0 | 500 | 9.000 |
| 22134 | 19604816 | 4.8 x 16 | 12.0 | 500 | 9.000 |
| 22135 | 19604818 | 4,8 x 18 | 14.0 | 500 | 9.000 |
| 22136 | 19604821 | 4.8 x 21 | 16.0 | 250 | 4.500 |
| 22137 | 19604825 | 4.8 x 25 | 21.0 | 250 | 4.500 |
| 22138 | 19604830 | 4.8 x 30 | 26.0 | 250 | 4.500 |

El Remache Ranurado ,
indicado para piezas cuyas
brocas no sean pasantes,
como paredes, ladrillos, etc.

El ranurado le da un mayor
eficacia en el agarre

REMACHE FLOR

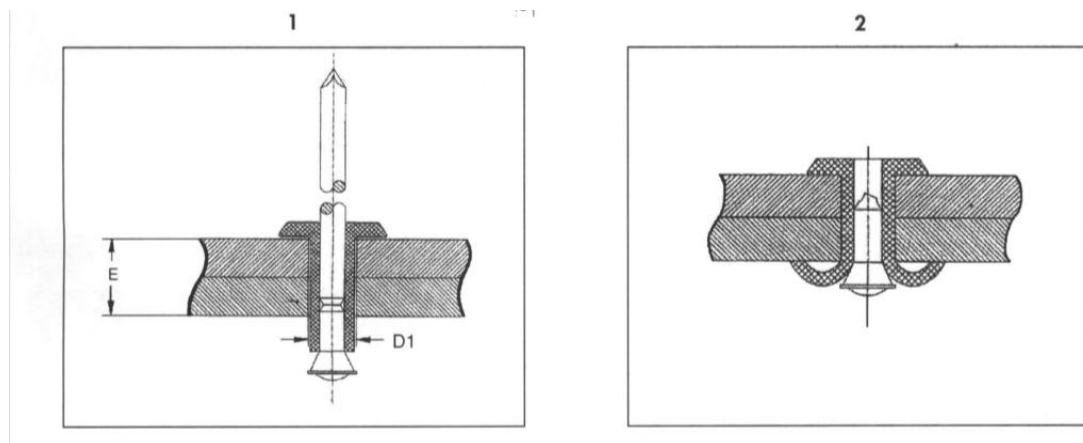

El remache tipo FLOR es apto para el fijado de cualquier objeto sobre materiales blandos como: plástico, pieles, madera, ladrillos perforados, asegurando de esta manera un óptimo acercamiento, también sobre superficies desiguales.

FAMILIA 2000



REMACHE FLOR ALU/ACE

PEEL RIVET (ALUMINIUM-STEEL)

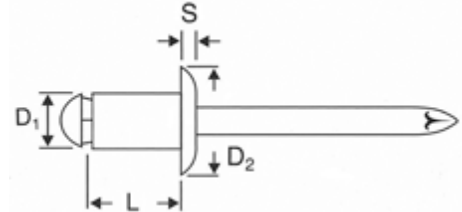

| CODIGO | BROCA Ø 3.2 D2: 6.0 /S:0.8 REFERENCIA | MEDIDA 3.2 D1 x L | ESPESOR | EMBALAJE | |
|--------|---|-------------------------|---------|----------|----------|
| | | | | INTERIOR | EXTERIOR |
| 00049 | 20003208 | 3,2 x 8 | 0,5-1,0 | 1.000 | 18.000 |
| 00050 | 20003210 | 3,2 x 10 | 1,0-3,0 | 1.000 | 18.000 |
| 00051 | 20003216 | 3,2 x 16 | 5,0-8,0 | 1.000 | 18.000 |

| CODIGO | BROCA Ø4.5 D2:8 /S:1.2 REFERENCIA | MEDIDA 4 D1 x L | ESPESOR | EMBALAJE | |
|--------|---|-----------------------|-----------|----------|----------|
| | | | | INTERIOR | EXTERIOR |
| 90008 | 20003908 | 3,9 x 8 | 0,5-3,0 | 1.000 | 18.000 |
| 90009 | 20003910 | 3,9 x 10 | 3,0-5,0 | 500 | 9.000 |
| 90010 | 20003912 | 3,9 x 12 | 5,0-7,0 | 500 | 9.000 |
| 90011 | 20003914 | 3,9 x 14 | 7,0-9,0 | 500 | 9.000 |
| 90012 | 20003915 | 3,9 x 15 | 9,0-10,0 | 500 | 9.000 |
| 90022 | 20003916 | 3,9 x 16 | 10,0-11,0 | 500 | 9.000 |
| 90016 | 20003918 | 3,9 x 18 | 11,0-13,0 | 500 | 9.000 |
| 90013 | 20003920 | 3,9 x 20 | 13,0-15,0 | 500 | 9.000 |
| 90014 | 20003924 | 3,9 x 24 | 15,0-20,0 | 500 | 9.000 |
| 90015 | 20003927 | 3,9 x 27 | 20,0-24,0 | 500 | 9.000 |
| 90016 | 20003930 | 3,9 x 30 | 24,0-28,0 | 250 | 4.500 |

REMACHE FLOR ALU/ACE

PEEL RIVET (ALUMINIUM-STEEL)

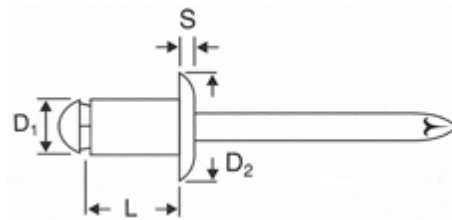

| CODIGO | BROCA Ø5.5 D2:9 /S:1.4 REFERENCIA | MEDIDA 5 D1 x L | EXPESOR | EMBALAJE | |
|--------|---|-----------------------|-------------|----------|----------|
| | | | | INTERIOR | EXTERIOR |
| 90017 | 20004908 | 4,9 x 8 | 0,5-4,0 | 500 | 9.000 |
| 90028 | 20004910 | 4,9 x 10 | 4,0-8,0 | 500 | 9.000 |
| 90029 | 20004912 | 4,9 x 12 | 6,0-8,0 | 500 | 9.000 |
| 90030 | 20004914 | 4,9 x 14 | 8,0-10,0 | 500 | 9.000 |
| 90031 | 20004915 | 4,9 x 15 | 10,0-11,0 | 500 | 9.000 |
| 90032 | 20004916 | 4,9 x 16 | 11,0-12,0 | 500 | 9.000 |
| 90033 | 20004918 | 4,9 x 18 | 12,0-14,0 | 500 | 9.000 |
| 90034 | 20004921 | 4,9 x 21 | 14,0-16,0 | 250 | 4.500 |
| 90035 | 20004924 | 4,9 x 24 | 16,0-18,0 | 250 | 4.500 |
| 90036 | 20004927 | 4,9 x 27 | 18,0-21,0 | 250 | 4.500 |
| 90037 | 20004930 | 4,9 x 30 | 21,0-25,0 | 250 | 4.500 |
| 90038 | 20004935 | 4,9 x 35 | 25,0-30,0 | 250 | 4.500 |
| 90039 | 20004940 | 4,9 x 40 | 30,0-35,0 | 200 | 3.600 |
| 90040 | 20004945 | 4,9 x 45 | 35,0-40,0 | 200 | 3.600 |
| 90041 | 20004950 | 4,9 x 50 | 40,0-45,0 | 150 | 2.700 |
| 90042 | 20004955 | 4,9 x 55 | 45,0-50,0 | 150 | 2.700 |
| 90043 | 20004960 | 4,9 x 60 | 50,0-55,0 | 100 | 1.800 |
| 90044 | 20004965 | 4,9 x 65 | 55,0-60,0 | 100 | 1.800 |
| 90045 | 20004970 | 4,9 x 70 | 60,0-65,0 | 100 | 1.800 |
| 90046 | 20004975 | 4,9 x 75 | 65,0-70,0 | 100 | 1.800 |
| 90047 | 20004980 | 4,9 x 80 | 70,0-75,0 | 100 | 1.800 |
| 90048 | 20004990 | 4,9 x 90 | 75,0-85,0 | 50 | 900 |
| 90049 | 200049100 | 4,9 x 100 | 85,0-95,0 | 50 | 900 |
| 90050 | 200049110 | 4,9 x 110 | 95,0-105,0 | 50 | 900 |
| 90051 | 200049120 | 4,9 x 120 | 105,0-115,0 | 50 | 900 |

REMACHE FLOR ALU/ACE

PEEL RIVET (ALUMINIUM-STEEL)

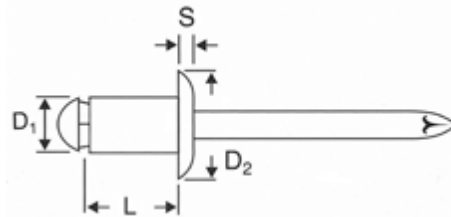

| CODIGO | BROCA Ø6.5 D2:12 /S:1.8 REFERENCIA | MEDIDA 6 D1 x L | ESPESOR | EMBALAJE | |
|--------|--|-----------------------|-----------|----------|----------|
| | | | | INTERIOR | EXTERIOR |
| 90052 | 20005908 | 5,9 x 8 | 1,0-4,0 | 500 | 9.000 |
| 90053 | 20005910 | 5,9 x 10 | 4,0-6,0 | 250 | 4.500 |
| 90254 | 20005912 | 5,9 x 12 | 6,0-8,0 | 250 | 4.500 |
| 90255 | 20005915 | 5,9 x 15 | 8,0-11,0 | 250 | 4.500 |
| 90056 | 20005918 | 5,9 x 18 | 11,0-13,0 | 250 | 4.500 |
| 90057 | 20005921 | 5,9 x 21 | 13,0-15,0 | 250 | 4.500 |
| 90059 | 20005924 | 5,9 x 24 | 15,0-19,0 | 200 | 3.600 |
| 00052 | 20005930 | 5,9 x 30 | 20,0-24,0 | 200 | 3.600 |
| 00053 | 20005935 | 5,9 x 35 | 24,0-29,0 | 200 | 3.600 |

| CODIGO | BROCA Ø 7 D2:13 /S:2 REFERENCIA | MEDIDA 6,4 D1 x L | ESPESOR | EMBALAJE | |
|--------|---------------------------------------|-------------------------|-----------|----------|----------|
| | | | | INTERIOR | EXTERIOR |
| 90060 | 20006411 | 6,4 x 11 | 2,0-5,0 | 250 | 4.500 |
| 90061 | 20006413 | 6,4 x 13 | 5,0-8,0 | 250 | 4.500 |
| 90062 | 20006415 | 6,4 x 15 | 8,0-11,0 | 250 | 4.500 |
| 90063 | 20006418 | 6,4 x 18 | 11,0-13,0 | 250 | 4.500 |
| 01322 | 20006420 | 6,4 x 20 | 13,0-15,0 | 200 | 3.600 |
| 01324 | 20006430 | 6,4 x 30 | 20,0-24,0 | 200 | 3.600 |
| 90074 | 20006435 | 6,4 x 35 | 24,0-29,0 | 200 | 3.600 |

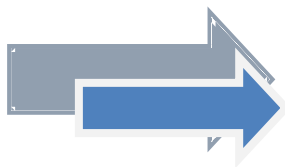

FABRICACION MAXIMA 120 mm – CONSULTAR

FAMILIA 2001



REMACHE FLOR BLANCO (ALU/ACE)

PEEL RIVET LACQUERED (ALUMINIUM-STEEL)

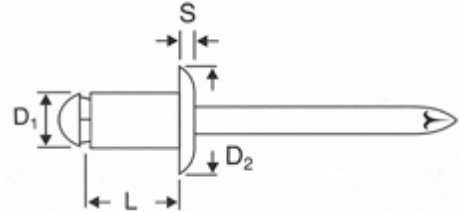

| CODIGO | BROCA Ø 4.5 D2:8 /S:1.2 REFERENCIA | MEDIDA 4 D1 x L | ESPESOR | EMBALAJE | |
|--------|--|-----------------------|-----------|----------|----------|
| | | | | INTERIOR | EXTERIOR |
| 49009 | 20013908 | 3,9 x 8 | 0,5-3,0 | 1.000 | 18.000 |
| 49010 | 20013910 | 3,9 x 10 | 3,0-5,0 | 500 | 9.000 |
| 49011 | 20013912 | 3,9 x 12 | 5,0-7,0 | 500 | 9.000 |
| 49012 | 20013914 | 3,9 x 14 | 7,0-9,0 | 500 | 9.000 |
| 49022 | 20013915 | 3,9 x 15 | 9,0-10,0 | 500 | 9.000 |
| 49016 | 20013916 | 3,9 x 16 | 10,0-11,0 | 500 | 9.000 |
| 49013 | 20013918 | 3,9 x 18 | 11,0-13,0 | 500 | 9.000 |
| 49014 | 20013920 | 3,9 x 20 | 13,0-15,0 | 500 | 9.000 |

| CODIGO | BROCA Ø 5.5 D2:9 /S:1.4 REFERENCIA | MEDIDA 5 D1 x L | ESPESOR | EMBALAJE | |
|--------|--|-----------------------|-----------|----------|----------|
| | | | | INTERIOR | EXTERIOR |
| 49029 | 20014910 | 4,9 x 10 | 4,0-8,0 | 500 | 9.000 |
| 49030 | 20014912 | 4,9 x 12 | 6,0-8,0 | 500 | 9.000 |
| 49031 | 20014914 | 4,9 x 14 | 8,0-10,0 | 500 | 9.000 |
| 49025 | 20014915 | 4,9 x 15 | 10,0-11,0 | 500 | 9.000 |
| 49032 | 20014916 | 4,9 x 16 | 11,0-12,0 | 500 | 9.000 |
| 49033 | 20014918 | 4,9 x 18 | 12,0-14,0 | 500 | 9.000 |
| 49034 | 20014921 | 4,9 x 21 | 14,0-16,0 | 250 | 4.500 |
| 49035 | 20014924 | 4,9 x 24 | 16,0-18,0 | 250 | 4.500 |
| 49036 | 20014927 | 4,9 x 27 | 18,0-21,0 | 250 | 4.500 |
| 49037 | 20014930 | 4,9 x 30 | 21,0-25,0 | 250 | 4.500 |

CONSULTAR: LA MEDIDA Y EL COLOR QUE NECESITE.

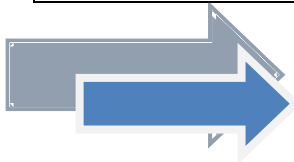

| COLOR | RAL | COLOR | RAL | COLOR | RAL |
|----------|------|---------|------|---------|------|
| AMARILLO | 1021 | MARRON | 8014 | BLANCO | 9010 |
| AZUL | 5010 | NARANJA | 2004 | NEGRO | 9005 |
| BRONCE | | ORO | | BURDEOS | 3004 |
| ROJO | 3000 | CREMA | 1015 | VERDE | 6002 |
| GRIS | 7035 | VERDE | 6005 | PLATA | |

FAMILIA 2002



REMACHE FLOR NEGRO (ALU/ ACE)

PEEL RIVET LACQUERED (ALUMINIUM-STEEL)

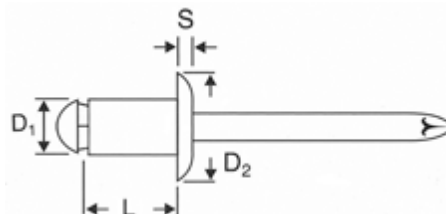

| CODIGO | BROCA Ø4.5 D2: 8 /S:1.2 REFERENCIA | MEDIDA 4 D1 x L | ESPESOR | EMBALAJE | |
|--------|--|-----------------------|-----------|----------|----------|
| | | | | INTERIOR | EXTERIOR |
| 49109 | 20023908 | 3,9 x 8 | 0,5-3,0 | 1.000 | 18.000 |
| 49110 | 20023910 | 3,9 x 10 | 3,0-5,0 | 500 | 9.000 |
| 49111 | 20023912 | 3,9 x 12 | 5,0-7,0 | 500 | 9.000 |
| 49112 | 20023914 | 3,9 x 14 | 7,0-9,0 | 500 | 9.000 |
| 49122 | 20023915 | 3,9 x 15 | 9,0-10,0 | 500 | 9.000 |
| 49116 | 20023916 | 3,9 x 16 | 10,0-11,0 | 500 | 9.000 |
| 49113 | 20023918 | 3,9 x 18 | 11,0-13,0 | 500 | 9.000 |
| 49114 | 20023920 | 3,9 x 20 | 13,0-15,0 | 500 | 9.000 |

| CODIGO | BROCA Ø5.5 D2: 9 /S:1.4 REFERENCIA | MEDIDA 5 D1 x L | ESPESOR | EMBALAJE | |
|--------|--|-----------------------|-----------|----------|----------|
| | | | | INTERIOR | EXTERIOR |
| 49129 | 20024910 | 4,9 x 10 | 4,0-8,0 | 500 | 9.000 |
| 49130 | 20024912 | 4,9 x 12 | 6,0-8,0 | 500 | 9.000 |
| 49131 | 20024914 | 4,9 x 14 | 8,0-10,0 | 500 | 9.000 |
| 49125 | 20024915 | 4,9 x 15 | 10,0-11,0 | 500 | 9.000 |
| 49132 | 20024916 | 4,9 x 16 | 11,0-12,0 | 500 | 9.000 |
| 49133 | 20024918 | 4,9 x 18 | 12,0-14,0 | 500 | 9.000 |
| 49134 | 20024921 | 4,9 x 21 | 14,0-16,0 | 250 | 4.500 |
| 49135 | 20024924 | 4,9 x 24 | 16,0-18,0 | 250 | 4.500 |
| 49136 | 20024927 | 4,9 x 27 | 18,0-21,0 | 250 | 4.500 |
| 49137 | 20024930 | 4,9 x 30 | 21,0-25,0 | 250 | 4.500 |

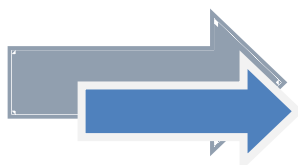

CONSULTAR: LA MEDIDA Y EL COLOR QUE NECESITE.

| COLOR | RAL | COLOR | RAL | COLOR | RAL |
|----------|------|---------|------|---------|------|
| AMARILLO | 1021 | MARRON | 8014 | BLANCO | 9010 |
| AZUL | 5010 | NARANJA | 2004 | NEGRO | 9005 |
| BRONCE | | ORO | | BURDEOS | 3004 |
| ROJO | 3000 | CREMA | 1015 | VERDE | 6002 |
| GRIS | 7035 | VERDE | 6005 | PLATA | |

FAMILIA 2100



REMACHE FLOR ALA ANCHA (ALU/ACE)

PEEL RIVET LARGE HEAD (ALUMINIUM-STEEL)

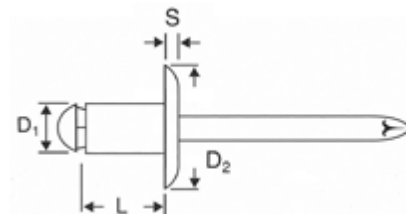

| CODIGO | BROCA \varnothing 4.5 D2: 10 /S:1.5 REFERENCIA | MEDIDA 4 D1 x L | ESPESOR | EMBALAJE | |
|--------|--|-----------------------|-----------|----------|----------|
| | | | | INTERIOR | EXTERIOR |
| 94023 | 21003908 | 3,9 x 8 | 0,5-3,0 | 1.000 | 18.000 |
| 94024 | 21003910 | 3,9 x 10 | 3,0-5,0 | 500 | 9.000 |
| 94025 | 21003912 | 3,9 x 12 | 5,0-7,0 | 500 | 9.000 |
| 94027 | 21003915 | 3,9 x 15 | 9,0-10,0 | 500 | 9.000 |
| 90064 | 21003916 | 3,9 x 16 | 10,0-11,0 | 500 | 9.000 |
| 94025 | 21003918 | 3,9 x 18 | 11,0-13,0 | 500 | 9.000 |
| 94014 | 21003920 | 3,9 x 20 | 13,0-15,0 | 500 | 9.000 |
| 94015 | 21003924 | 3,9 x 24 | 16,5-20,5 | 250 | 4.500 |

| CODIGO | BROCA \varnothing 5.5 D2:14 /S:1.5 REFERENCIA | MEDIDA 5 D1 x L | ESPESOR | EMBALAJE | |
|--------|---|-----------------------|-----------|----------|----------|
| | | | | INTERIOR | EXTERIOR |
| 94029 | 21004910 | 4,9 x 10 | 4,0-8,0 | 500 | 9.000 |
| 94030 | 21004912 | 4,9 x 12 | 6,0-8,0 | 500 | 9.000 |
| 94031 | 21004914 | 4,9 x 14 | 8,0-10,0 | 500 | 9.000 |
| 94054 | 21004916 | 4,9 x 16 | 11,0-12,0 | 500 | 9.000 |
| 94033 | 21004918 | 4,9 x 18 | 12,0-14,0 | 500 | 9.000 |
| 94034 | 21004921 | 4,9 x 21 | 14,0-16,0 | 250 | 4.500 |
| 94035 | 21004924 | 4,9 x 24 | 16,0-18,0 | 250 | 4.500 |
| 94039 | 21004927 | 4,9 x 27 | 18,0-21,0 | 250 | 4.500 |
| 94037 | 21004930 | 4,9 x 30 | 21,0-25,0 | 250 | 4.500 |
| 94038 | 21004935 | 4,9 x 35 | 25,0-30,0 | 250 | 4.500 |

FAMILIA 2101



REMACHE FLOR ALA ANCHA BLANCO

(ALUMINIO – ACERO)

PEEL RIVET LARGE HEAD LACQUERED (ALUMINIUM-STEEL)

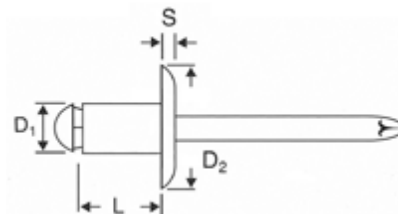

| CODIGO | BROCA Ø 4.5 D2:10 /S:1.5 REFERENCIA | MEDIDA 4 D1 x L | ESPESOR | EMBALAJE | |
|--------|---|-----------------------|-----------|----------|----------|
| | | | | INTERIOR | EXTERIOR |
| 89994 | 21013908 | 3,9 x 8 | 0,5-3,0 | 1.000 | 18.000 |
| 89995 | 21013910 | 3,9 x 10 | 3,0-5,0 | 500 | 9.000 |
| 89996 | 21013912 | 3,9 x 12 | 5,0-7,0 | 500 | 9.000 |
| 89997 | 21013914 | 3,9 x 14 | 7,0-9,0 | 500 | 9.000 |
| 89998 | 21013915 | 3,9 x 15 | 9,0-10,0 | 500 | 9.000 |
| 89999 | 21013916 | 3,9 x 16 | 10,0-11,0 | 500 | 9.000 |
| 89983 | 21013918 | 3,9 x 18 | 11,0-13,0 | 500 | 9.000 |
| 89984 | 21013920 | 3,9 x 20 | 13,0-15,0 | 500 | 9.000 |

| CODIGO | BROCA Ø 5.5 D2:14 /S:1.5 REFERENCIA | MEDIDA 5 D1 x L | EXPESOR | EMBALAJE | |
|--------|---|-----------------------|-----------|----------|----------|
| | | | | INTERIOR | EXTERIOR |
| 89986 | 21014910 | 4,9 x 10 | 4,0-8,0 | 500 | 9.000 |
| 89987 | 21014912 | 4,9 x 12 | 6,0-8,0 | 500 | 9.000 |
| 89988 | 21014914 | 4,9 x 14 | 8,0-10,0 | 500 | 9.000 |
| 89989 | 21014915 | 4,9 x 15 | 10,0-11,0 | 500 | 9.000 |
| 90001 | 21014916 | 4,9 x 16 | 11,0-12,0 | 500 | 9.000 |
| 90101 | 21014918 | 4,9 x 18 | 12,0-14,0 | 500 | 9.000 |
| 90000 | 21014921 | 4,9 x 21 | 14,0-16,0 | 250 | 4.500 |
| 89990 | 21014924 | 4,9 x 24 | 16,0-18,0 | 250 | 4.500 |
| 89991 | 21014927 | 4,9 x 27 | 18,0-21,0 | 250 | 4.500 |
| 89992 | 21014930 | 4,9 x 30 | 21,0-25,0 | 250 | 4.500 |
| 89993 | 21014935 | 4,9 x 35 | 25,0-30,0 | 250 | 4.500 |

CONSULTAR: LA MEDIDA Y EL COLOR QUE NECESITE.



| COLOR | RAL | COLOR | RAL | COLOR | RAL |
|----------|------|---------|------|---------|------|
| AMARILLO | 1021 | MARRON | 8014 | BLANCO | 9010 |
| AZUL | 5010 | NARANJA | 2004 | NEGRO | 9005 |
| BRONCE | | ORO | | BURDEOS | 3004 |
| ROJO | 3000 | CREMA | 1015 | VERDE | 6002 |
| GRIS | 7035 | VERDE | 6005 | PLATA | |

FAMILIA 2102



REMACHE FLOR ALA ANCHA NEGRO

(ALUMINIO - ACERO)

PEEL RIVET LARGE HEAD LACQUERED (ALUMINIUM-STEEL)

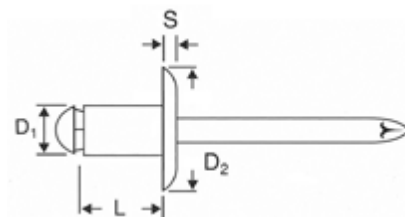

| CODIGO | BROCA ϕ 4.5 D2:10 /S:1.5 REFERENCIA | MEDIDA 4 D1 x L | ESPESOR | EMBALAJE | |
|--------|--|-----------------------|-----------|----------|----------|
| | | | | INTERIOR | EXTERIOR |
| 89194 | 21023908 | 3,9 x 8 | 0,5-3,0 | 1.000 | 18.000 |
| 89195 | 21023910 | 3,9 x 10 | 3,0-5,0 | 500 | 9.000 |
| 89196 | 21023912 | 3,9 x 12 | 5,0-7,0 | 500 | 9.000 |
| 91001 | 21023914 | 3,9 x 14 | 7,0-9,0 | 500 | 9.000 |
| 89198 | 21023915 | 3,9 x 15 | 9,0-10,0 | 500 | 9.000 |
| 89199 | 21023916 | 3,9 x 16 | 10,0-11,0 | 500 | 9.000 |
| 91002 | 21023918 | 3,9 x 118 | 11,0-13,0 | 500 | 9.000 |
| 91003 | 21023920 | 3,9 x 20 | 13,0-15,0 | 500 | 9.000 |

| CODIGO | BROCA ϕ 5.5 D2: 14 /S:1.5 REFERENCIA | MEDIDA 5 D1 x L | EXPESOR | EMBALAJE | |
|--------|---|-----------------------|-----------|----------|----------|
| | | | | INTERIOR | EXTERIOR |
| 89186 | 21024910 | 4,9 x 10 | 4,0-8,0 | 500 | 9.000 |
| 89187 | 21024912 | 4,9 x 12 | 6,0-8,0 | 500 | 9.000 |
| 89188 | 21024914 | 4,9 x 14 | 8,0-10,0 | 500 | 9.000 |
| 89189 | 21024915 | 4,9 x 15 | 10,0-11,0 | 500 | 9.000 |
| 91004 | 21024916 | 4,9 x 16 | 11,0-12,0 | 500 | 9.000 |
| 91005 | 21024918 | 4,9 x 18 | 12,0-14,0 | 500 | 9.000 |
| 91006 | 21024921 | 4,9 x 21 | 14,0-16,0 | 250 | 4.500 |
| 89190 | 21024924 | 4,9 x 24 | 16,0-18,0 | 250 | 4.500 |
| 89191 | 21024927 | 4,9 x 27 | 18,0-21,0 | 250 | 4.500 |
| 89192 | 21024930 | 4,9 x 30 | 21,0-25,0 | 250 | 4.500 |
| 89193 | 21024935 | 4,9 x 35 | 25,0-30,0 | 250 | 4.500 |

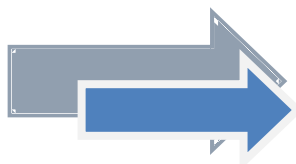

CONSULTAR: LA MEDIDA Y EL COLOR QUE NECESITE.

| COLOR | RAL | COLOR | RAL | COLOR | RAL |
|----------|------|---------|------|---------|------|
| AMARILLO | 1021 | MARRON | 8014 | BLANCO | 9010 |
| AZUL | 5010 | NARANJA | 2004 | NEGRO | 9005 |
| BRONCE | | ORO | | BURDEOS | 3004 |
| ROJO | 3000 | CREMA | 1015 | VERDE | 6002 |
| GRIS | 7035 | VERDE | 6005 | PLATA | |

FAMILIA 2200



REMACHE FLOR ALA SUPER ANCHA (ALU/ACE)

PEEL RIVET LARGE HEAD (ALUMINIUM-STEEL)

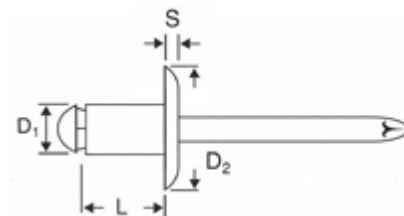

| CODIGO | BROCA Ø 4.5 D2:12 /S:1.5 REFERENCIA | MEDIDA 4 D1 x L | ESPESOR | EMBALAJE | |
|--------|---|-----------------------|-----------|----------|----------|
| | | | | INTERIOR | EXTERIOR |
| 00055 | 22003908 | 3,9 x 8 | 0,5-3,0 | 1.000 | 18.000 |
| 00056 | 22003910 | 3,9 x 10 | 3,0-5,0 | 500 | 9.000 |
| 00057 | 22003912 | 3,9 x 12 | 5,0-7,0 | 500 | 9.000 |
| 00058 | 22003915 | 3,9 x 15 | 9,0-10,0 | 500 | 9.000 |
| 00059 | 22003916 | 3,9 x 16 | 10,0-11,0 | 500 | 9.000 |
| 00060 | 22003918 | 3,9 x 18 | 11,0-13,0 | 500 | 9.000 |
| 00061 | 22003920 | 3,9 x 20 | 13,0-15,0 | 500 | 9.000 |
| 00062 | 22003924 | 3,9 x 24 | 16,5-20,5 | 250 | 4.500 |

| CODIGO | BROCA Ø 5.5 D2:16 /S:1.5 REFERENCIA | MEDIDA 5 D1 x L | ESPESOR | EMBALAJE | |
|--------|---|-----------------------|-----------|----------|----------|
| | | | | INTERIOR | EXTERIOR |
| 00063 | 22004910 | 4,9 x 10 | 4,0-8,0 | 500 | 9.000 |
| 00064 | 22004912 | 4,9 x 12 | 6,0-8,0 | 500 | 9.000 |
| 00065 | 22004914 | 4,9 x 14 | 8,0-10,0 | 500 | 9.000 |
| 00066 | 22004916 | 4,9 x 16 | 11,0-12,0 | 500 | 9.000 |
| 00067 | 22004918 | 4,9 x 18 | 12,0-14,0 | 500 | 9.000 |
| 00068 | 22004921 | 4,9 x 21 | 14,0-16,0 | 250 | 4.500 |
| 00069 | 22004924 | 4,9 x 24 | 16,0-18,0 | 250 | 4.500 |
| 00070 | 22004927 | 4,9 x 27 | 18,0-21,0 | 250 | 4.500 |
| 00071 | 22004930 | 4,9 x 30 | 21,0-25,0 | 250 | 4.500 |
| 00072 | 22004935 | 4,9 x 35 | 25,0-30,0 | 250 | 4.500 |

FAMILIA 2201



REMACHE FLOR ALA SUPER ANCHA BLANCO

(ALUMINIO – ACERO)

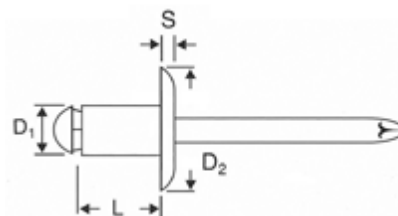

PEEL RIVET LARGE HEAD LACQUERED (ALUMINIUM-STEEL)

| CODIGO | BROCA Ø 4.5 D2:12 /S:1.5 REFERENCIA | MEDIDA 4 D1 x L | ESPESOR | EMBALAJE | |
|--------|---|-----------------------|-----------|----------|----------|
| | | | | INTERIOR | EXTERIOR |
| 00073 | 22013908 | 3,9 x 8 | 0,5-3,0 | 1.000 | 18.000 |
| 00074 | 22013910 | 3,9 x 10 | 3,0-5,0 | 500 | 9.000 |
| 00075 | 22013912 | 3,9 x 12 | 5,0-7,0 | 500 | 9.000 |
| 00076 | 22013914 | 3,9 x 14 | 7,0-9,0 | 500 | 9.000 |
| 01329 | 22013915 | 3,9 x 15 | 9,0-10,0 | 500 | 9.000 |
| 00077 | 22013916 | 3,9 x 16 | 10,0-11,0 | 500 | 9.000 |
| 00078 | 22013918 | 3,9 x 18 | 11,0-13,0 | 500 | 9.000 |
| 00079 | 22013920 | 3,9 x 20 | 13,0-15,0 | 500 | 9.000 |

| CODIGO | BROCA Ø 5.5 D2:12 /S:1.5 REFERENCIA | MEDIDA 5 D1 x L | ESPESOR | EMBALAJE | |
|--------|---|-----------------------|-----------|----------|----------|
| | | | | INTERIOR | EXTERIOR |
| 00080 | 22014910 | 4,9 x 10 | 4,0-8,0 | 500 | 9.000 |
| 00081 | 22014912 | 4,9 x 12 | 6,0-8,0 | 500 | 9.000 |
| 00082 | 22014914 | 4,9 x 14 | 8,0-10,0 | 500 | 9.000 |
| 00082 | 22014915 | 4,9 x 15 | 10,0-11,0 | 500 | 9.000 |
| 00083 | 22014916 | 4,9 x 16 | 11,0-12,0 | 500 | 9.000 |
| 00084 | 22014918 | 4,9 x 18 | 12,0-14,0 | 500 | 9.000 |
| 00085 | 22014921 | 4,9 x 21 | 14,0-16,0 | 250 | 4.500 |
| 00086 | 22014924 | 4,9 x 24 | 16,0-18,0 | 250 | 4.500 |
| 00087 | 22014927 | 4,9 x 27 | 18,0-21,0 | 250 | 4.500 |
| 00088 | 22014930 | 4,9 x 30 | 21,0-25,0 | 250 | 4.500 |
| 00089 | 22014935 | 4,9 x 35 | 25,0-30,0 | 250 | 4.500 |

CONSULTAR: LA MEDIDA Y EL COLOR QUE NECESITE.

| COLOR | RAL | COLOR | RAL | COLOR | RAL |
|----------|------|---------|------|---------|------|
| AMARILLO | 1021 | MARRON | 8014 | BLANCO | 9010 |
| AZUL | 5010 | NARANJA | 2004 | NEGRO | 9005 |
| BRONCE | | ORO | | BURDEOS | 3004 |
| ROJO | 3000 | CREMA | 1015 | VERDE | 6002 |
| GRIS | 7035 | VERDE | 6005 | PLATA | |

FABRICACION BAJO PEDIDO – CONSULTAR DISPONIBILIDAD

FAMILIA 2202



REMACHE FLOR ALA SUPER ANCHA NEGRO

(ALUMINIO – ACERO)

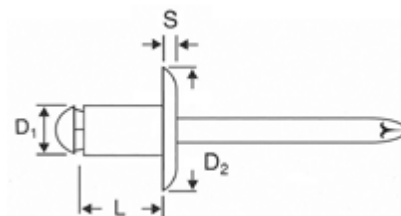

PEEL RIVET LARGE HEAD LACQUERED (ALUMINIUM-STEEL)

| CODIGO | BROCA Ø 4.5 D2: 12 /S:1.5 REFERENCIA | MEDIDA 4 D1 x L | ESPESOR | EMBALAJE | |
|--------|--|-----------------------|-----------|----------|----------|
| | | | | INTERIOR | EXTERIOR |
| 00090 | 22023908 | 3,9 x 8 | 0,5-3,0 | 1.000 | 18.000 |
| 00091 | 22023910 | 3,9 x 10 | 3,0-5,0 | 500 | 9.000 |
| 00092 | 22023912 | 3,9 x 12 | 5,0-7,0 | 500 | 9.000 |
| 00093 | 22023914 | 3,9 x 14 | 7,0-9,0 | 500 | 9.000 |
| 01330 | 22023915 | 3,9 x 15 | 9,0-10,0 | 500 | 9.000 |
| 00094 | 22023916 | 3,9 x 16 | 10,0-11,0 | 500 | 9.000 |
| 00095 | 22023918 | 3,9 x 18 | 11,0-13,0 | 500 | 9.000 |
| 00096 | 22023920 | 3,9 x 20 | 13,0-15,0 | 500 | 9.000 |

| CODIGO | BROCA Ø 5.5 D2:16 /S:1.5 REFERENCIA | MEDIDA 5 D1 x L | ESPESOR | EMBALAJE | |
|--------|---|-----------------------|-----------|----------|----------|
| | | | | INTERIOR | EXTERIOR |
| 00097 | 22024910 | 4,9 x 10 | 4,0-8,0 | 500 | 9.000 |
| 00098 | 22024912 | 4,9 x 12 | 6,0-8,0 | 500 | 9.000 |
| 00099 | 22024914 | 4,9 x 14 | 8,0-10,0 | 500 | 9.000 |
| 01331 | 22024915 | 4,9 x 15 | 10,0-11,0 | 500 | 9.000 |
| 00100 | 22024916 | 4,9 x 16 | 11,0-12,0 | 500 | 9.000 |
| 00101 | 22024918 | 4,9 x 18 | 12,0-14,0 | 500 | 9.000 |
| 00102 | 22024921 | 4,9 x 21 | 14,0-16,0 | 250 | 4.500 |
| 00103 | 22024924 | 4,9 x 24 | 16,0-18,0 | 250 | 4.500 |
| 00104 | 22024927 | 4,9 x 27 | 18,0-21,0 | 250 | 4.500 |
| 00105 | 22024930 | 4,9 x 30 | 21,0-25,0 | 250 | 4.500 |
| 00106 | 22024935 | 4,9 x 35 | 25,0-30,0 | 250 | 4.500 |

CONSULTAR: LA MEDIDA Y EL COLOR QUE NECESITE.

FABRICACION BAJO PEDIDO – CONSULTAR DISPONIBILIDAD

| COLOR | RAL | COLOR | RAL | COLOR | RAL |
|----------|------|---------|------|---------|------|
| AMARILLO | 1021 | MARRON | 8014 | BLANCO | 9010 |
| AZUL | 5010 | NARANJA | 2004 | NEGRO | 9005 |
| BRONCE | | ORO | | BURDEOS | 3004 |
| ROJO | 3000 | CREMA | 1015 | VERDE | 6002 |
| GRIS | 7035 | VERDE | 6005 | PLATA | |

FAMILIA 2500



REMACHE FLOR (ALUMINIO-INOX)

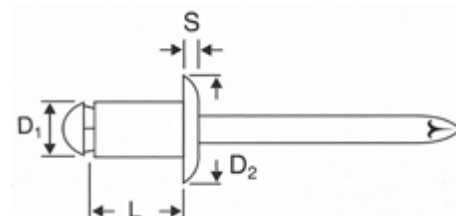

PEEL RIVET LARGE HEAD (ALUMINIUM-STAINLESS STEEL)

| CODIGO | BROCA \varnothing 4.5 D2: 8/S:1.5 REFERENCIA | MEDIDA 4 D1 x L | ESPESOR | EMBALAJE | |
|--------|--|-----------------------|-----------|----------|----------|
| | | | | INTERIOR | EXTERIOR |
| 00126 | 25003908 | 3,9 x 8 | 0,5-3,0 | 1.000 | 18.000 |
| 00127 | 25003910 | 3,9 x 10 | 3,0-5,0 | 500 | 9.000 |
| 00128 | 25003912 | 3,9 x 12 | 5,0-7,0 | 500 | 9.000 |
| 00129 | 25003914 | 3,9 x 14 | 7,0-9,0 | 500 | 9.000 |
| 00130 | 25003915 | 3,9 x 15 | 9,0-10,0 | 500 | 9.000 |
| 00131 | 25003916 | 3,9 x 16 | 10,0-11,0 | 500 | 9.000 |
| 00132 | 25003918 | 3,9 x 18 | 11,0-13,0 | 500 | 9.000 |
| 00133 | 25003920 | 3,9 x 20 | 13,0-15,0 | 500 | 9.000 |

| CODIGO | BROCA \varnothing 5.5 D2: 9/S:1.5 REFERENCIA | MEDIDA 5 D1 x L | ESPESOR | EMBALAJE | |
|--------|--|-----------------------|-----------|----------|----------|
| | | | | INTERIOR | EXTERIOR |
| 00138 | 25004910 | 4,9 x 10 | 4,0-8,0 | 500 | 9.000 |
| 00139 | 25004912 | 4,9 x 12 | 6,0-8,0 | 500 | 9.000 |
| 00140 | 25004914 | 4,9 x 14 | 8,0-10,0 | 500 | 9.000 |
| 00141 | 25004915 | 4,9 x 15 | 10,0-11,0 | 500 | 9.000 |
| 00142 | 25004916 | 4,9 x 16 | 11,0-12,0 | 500 | 9.000 |
| 00143 | 25004918 | 4,9 x 18 | 12,0-14,0 | 500 | 9.000 |
| 00144 | 25004921 | 4,9 x 21 | 14,0-16,0 | 250 | 4.500 |
| 00145 | 25004924 | 4,9 x 24 | 16,0-18,0 | 250 | 4.500 |
| 00146 | 25004927 | 4,9 x 27 | 18,0-21,0 | 250 | 4.500 |
| 00147 | 25004930 | 4,9 x 30 | 21,0-25,0 | 250 | 4.500 |
| 00148 | 25004935 | 4,9 x 35 | 25,0-30,0 | 250 | 4.500 |

FABRICACION BAJO PEDIDO – CONSULTAR DISPONIBILIDAD

FAMILIA 2501



REMACHE FLOR LACADO BLANCO

(ALUMINIO-INOX)

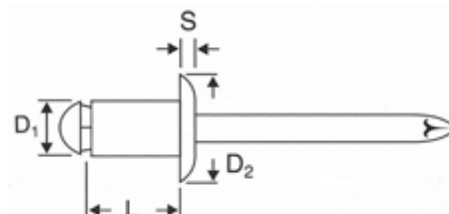

PEEL RIVET LARGE HEAD HEAD LACQUERED (ALUMINIUM-STAINLESS STEEL)

| CODIGO | BROCA Ø 4.5 D2:8 /S:1.2 REFERENCIA | MEDIDA 4 D1 x L | ESPESOR | EMBALAJE | |
|--------|--|-----------------------|-----------|----------|----------|
| | | | | INTERIOR | EXTERIOR |
| 00177 | 25013908 | 3,9 x 8 | 0,5-3,0 | 1.000 | 18.000 |
| 00178 | 25013910 | 3,9 x 10 | 3,0-5,0 | 500 | 9.000 |
| 00179 | 25013912 | 3,9 x 12 | 5,0-7,0 | 500 | 9.000 |
| 00180 | 25013914 | 3,9 x 14 | 7,0-9,0 | 500 | 9.000 |
| 00181 | 25013915 | 3,9 x 15 | 9,0-10,0 | 500 | 9.000 |
| 00182 | 25013916 | 3,9 x 16 | 10,0-11,0 | 500 | 9.000 |
| 00183 | 25013918 | 3,9 x 18 | 11,0-13,0 | 500 | 9.000 |
| 00184 | 25013920 | 3,9 x 20 | 13,0-15,0 | 500 | 9.000 |

| CODIGO | BROCA Ø 5.5 D2: 9 /S:1.4 REFERENCIA | MEDIDA 5 D1 x L | ESPESOR | EMBALAJE | |
|--------|---|-----------------------|-----------|----------|----------|
| | | | | INTERIOR | EXTERIOR |
| 00185 | 25014910 | 4,9 x 10 | 4,0-8,0 | 500 | 9.000 |
| 00186 | 25014912 | 4,9 x 12 | 6,0-8,0 | 500 | 9.000 |
| 00187 | 25014914 | 4,9 x 14 | 8,0-10,0 | 500 | 9.000 |
| 00188 | 25014915 | 4,9 x 15 | 10,0-11,0 | 500 | 9.000 |
| 00189 | 25014916 | 4,9 x 16 | 11,0-12,0 | 500 | 9.000 |
| 00190 | 25014918 | 4,9 x 18 | 12,0-14,0 | 500 | 9.000 |
| 00191 | 25014921 | 4,9 x 21 | 14,0-16,0 | 250 | 4.500 |
| 00192 | 25014924 | 4,9 x 24 | 16,0-18,0 | 250 | 4.500 |
| 00193 | 25014927 | 4,9 x 27 | 18,0-21,0 | 250 | 4.500 |
| 00194 | 25014930 | 4,9 x 30 | 21,0-25,0 | 250 | 4.500 |
| 00195 | 25014935 | 4,9 x 35 | 25,0-30,0 | 250 | 4.500 |

FABRICACION BAJO PEDIDO – CONSULTA DISPONIBILIDAD

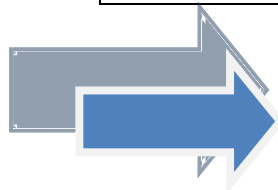

| COLOR | RAL | COLOR | RAL | COLOR | RAL |
|----------|------|---------|------|---------|------|
| AMARILLO | 1021 | MARRON | 8014 | BLANCO | 9010 |
| AZUL | 5010 | NARANJA | 2004 | NEGRO | 9005 |
| BRONCE | | ORO | | BURDEOS | 3004 |
| ROJO | 3000 | CREMA | 1015 | VERDE | 6002 |
| GRIS | 7035 | VERDE | 6005 | PLATA | |

FAMILIA 2502



REMACHE FLOR LACADO NEGRO

(ALUMINIO-INOX)

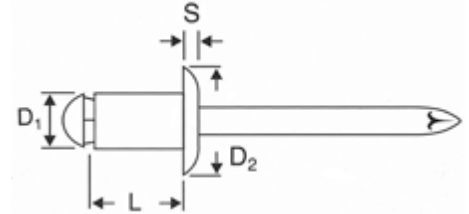

PEEL RIVET LARGE HEAD HEAD LACQUERED (ALUMINIUM-STAINLESS STEEL)

| CODIGO | BROCA Ø 4.5 D2: 8 /S:1.2 REFERENCIA | MEDIDA 4 D1 x L | ESPESOR | EMBALAJE | |
|--------|---|-----------------------|-----------|----------|----------|
| | | | | INTERIOR | EXTERIOR |
| 00196 | 25023908 | 3,9 x 8 | 0,5-3,0 | 1.000 | 18.000 |
| 00197 | 25023910 | 3,9 x 10 | 3,0-5,0 | 500 | 9.000 |
| 00198 | 25023912 | 3,9 x 12 | 5,0-7,0 | 500 | 9.000 |
| 00199 | 25023914 | 3,9 x 14 | 7,0-9,0 | 500 | 9.000 |
| 00200 | 25023915 | 3,9 x 15 | 9,0-10,0 | 500 | 9.000 |
| 00201 | 25013916 | 3,9 x 16 | 10,0-11,0 | 500 | 9.000 |
| 00202 | 25023918 | 3,9 x 18 | 11,0-13,0 | 500 | 9.000 |
| 00203 | 25023920 | 3,9 x 20 | 13,0-15,0 | 500 | 9.000 |

| CODIGO | BROCA Ø 5.5 D2:9 /S:1.4 REFERENCIA | MEDIDA 5 D1 x L | ESPESOR | EMBALAJE | |
|--------|--|-----------------------|-----------|----------|----------|
| | | | | INTERIOR | EXTERIOR |
| 00204 | 25024910 | 4,9 x 10 | 4,0-8,0 | 500 | 9.000 |
| 00205 | 25024912 | 4,9 x 12 | 6,0-8,0 | 500 | 9.000 |
| 00206 | 25024914 | 4,9 x 14 | 8,0-10,0 | 500 | 9.000 |
| 00207 | 25024915 | 4,9 x 15 | 10,0-11,0 | 500 | 9.000 |
| 00208 | 25024916 | 4,9 x 16 | 11,0-12,0 | 500 | 9.000 |
| 00209 | 25014918 | 4,9 x 18 | 12,0-14,0 | 500 | 9.000 |
| 00210 | 25024921 | 4,9 x 21 | 14,0-16,0 | 250 | 4.500 |
| 00211 | 25024924 | 4,9 x 24 | 16,0-18,0 | 250 | 4.500 |
| 00212 | 25024927 | 4,9 x 27 | 18,0-21,0 | 250 | 4.500 |
| 00213 | 25024930 | 4,9 x 30 | 21,0-25,0 | 250 | 4.500 |
| 00214 | 25024935 | 4,9 x 35 | 25,0-30,0 | 250 | 4.500 |



FABRICACION BAJO PEDIDO – CONSULTAR DISPONIBILIDAD

| COLOR | RAL | COLOR | RAL | COLOR | RAL |
|----------|------|---------|------|---------|------|
| AMARILLO | 1021 | MARRON | 8014 | BLANCO | 9010 |
| AZUL | 5010 | NARANJA | 2004 | NEGRO | 9005 |
| BRONCE | | ORO | | BURDEOS | 3004 |
| ROJO | 3000 | CREMA | 1015 | VERDE | 6002 |
| GRIS | 7035 | VERDE | 6005 | PLATA | |

FAMILIA 2510



REMACHE FLOR ALA ANCHA (ALUMINIO-INOX)

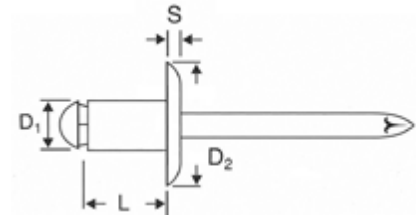

PEEL RIVET LARGE HEAD (ALUMINIUM-STAINLESS STEEL)

| CODIGO | BROCA Ø 4.5 D2:10 /S:1.2 REFERENCIA | MEDIDA 4 D1 x L | ESPESOR | EMBALAJE | |
|--------|---|-----------------------|-----------|----------|----------|
| | | | | INTERIOR | EXTERIOR |
| 00215 | 25103908 | 3,9 x 8 | 0,5-3,0 | 1.000 | 18.000 |
| 00216 | 25103910 | 3,9 x 10 | 3,0-5,0 | 500 | 9.000 |
| 00217 | 25103912 | 3,9 x 12 | 5,0-7,0 | 500 | 9.000 |
| 00218 | 25103914 | 3,9 x 14 | 7,0-9,0 | 500 | 9.000 |
| 00219 | 25103915 | 3,9 x 15 | 9,0-10,0 | 500 | 9.000 |
| 00220 | 25103916 | 3,9 x 16 | 10,0-11,0 | 500 | 9.000 |
| 00221 | 25103918 | 3,9 x 18 | 11,0-13,0 | 500 | 9.000 |
| 00222 | 25103920 | 3,9 x 20 | 13,0-15,0 | 500 | 9.000 |

| CODIGO | BROCA Ø 5.3 D2: 14 /S:1.4 REFERENCIA | MEDIDA 5 D1 x L | ESPESOR | EMBALAJE | |
|--------|--|-----------------------|-----------|----------|----------|
| | | | | INTERIOR | EXTERIOR |
| 00223 | 25104910 | 4,9 x 10 | 4,0-8,0 | 500 | 9.000 |
| 00224 | 25104912 | 4,9 x 12 | 6,0-8,0 | 500 | 9.000 |
| 00225 | 25104914 | 4,9 x 14 | 8,0-10,0 | 500 | 9.000 |
| 00226 | 25104915 | 4,9 x 15 | 10,0-11,0 | 500 | 9.000 |
| 00227 | 25104916 | 4,9 x 16 | 11,0-12,0 | 500 | 9.000 |
| 00228 | 25104918 | 4,9 x 18 | 12,0-14,0 | 500 | 9.000 |
| 00229 | 25104921 | 4,9 x 21 | 14,0-16,0 | 250 | 4.500 |
| 00230 | 25104924 | 4,9 x 24 | 16,0-18,0 | 250 | 4.500 |
| 00231 | 25104927 | 4,9 x 27 | 18,0-21,0 | 250 | 4.500 |
| 00232 | 25104930 | 4,9 x 30 | 21,0-25,0 | 250 | 4.500 |
| 00233 | 25104935 | 4,9 x 35 | 25,0-30,0 | 250 | 4.500 |



FABRICACION BAJO PEDIDO – CONSULTAR DISPONIBILIDAD

FAMILIA 2511



REMACHE FLOR ALA ANCHA BLANCO

(ALUMINIO-INOX)

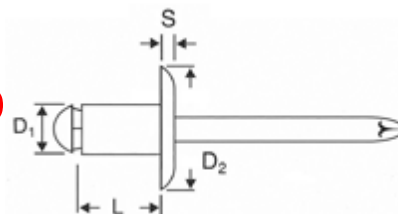

PEEL RIVET LARGE HEAD HEAD LACQUERED (ALUMINIUM-STAINLESS STEEL)

| CODIGO | BROCA Ø 4.5 D2:10 /S:1.2 REFERENCIA | MEDIDA 4 D1 x L | EXPESOR | EMBALAJE | |
|--------|---|-----------------------|-----------|----------|----------|
| | | | | INTERIOR | EXTERIOR |
| 00234 | 25113908 | 3,9 x 8 | 0,5-3,0 | 1.000 | 18.000 |
| 00235 | 25113910 | 3,9 x 10 | 3,0-5,0 | 500 | 9.000 |
| 00236 | 25113912 | 3,9 x 12 | 5,0-7,0 | 500 | 9.000 |
| 00237 | 25113914 | 3,9 x 14 | 7,0-9,0 | 500 | 9.000 |
| 00238 | 25113915 | 3,9 x 15 | 9,0-10,0 | 500 | 9.000 |
| 00239 | 25113916 | 3,9 x 16 | 10,0-11,0 | 500 | 9.000 |
| 00240 | 25113918 | 3,9 x 18 | 11,0-13,0 | 500 | 9.000 |
| 00241 | 25113920 | 3,9 x 20 | 13,0-15,0 | 500 | 9.000 |

| CODIGO | BROCA Ø 5.3 D2: 14 /S:1.4 REFERENCIA | MEDIDA 5 D1 x L | EXPESOR | EMBALAJE | |
|--------|--|-----------------------|-----------|----------|----------|
| | | | | INTERIOR | EXTERIOR |
| 00242 | 25114910 | 4,9 x 10 | 4,0-8,0 | 500 | 9.000 |
| 00243 | 25114912 | 4,9 x 12 | 6,0-8,0 | 500 | 9.000 |
| 00244 | 25114914 | 4,9 x 14 | 8,0-10,0 | 500 | 9.000 |
| 00245 | 25114915 | 4,9 x 15 | 10,0-11,0 | 500 | 9.000 |
| 00246 | 25114916 | 4,9 x 16 | 11,0-12,0 | 500 | 9.000 |
| 00247 | 25114918 | 4,9 x 18 | 12,0-14,0 | 500 | 9.000 |
| 00248 | 25114921 | 4,9 x 21 | 14,0-16,0 | 250 | 4.500 |
| 00249 | 25114924 | 4,9 x 24 | 16,0-18,0 | 250 | 4.500 |
| 00250 | 25114927 | 4,9 x 27 | 18,0-21,0 | 250 | 4.500 |
| 00251 | 25114930 | 4,9 x 30 | 21,0-25,0 | 250 | 4.500 |
| 00252 | 25114935 | 4,9 x 35 | 25,0-30,0 | 250 | 4.500 |



FABRICACION BAJO PEDIDO – CONSULTAR DISPONIBILIDAD

| COLOR | RAL | COLOR | RAL | COLOR | RAL |
|----------|------|---------|------|---------|------|
| AMARILLO | 1021 | MARRON | 8014 | BLANCO | 9010 |
| AZUL | 5010 | NARANJA | 2004 | NEGRO | 9005 |
| BRONCE | | ORO | | BURDEOS | 3004 |
| ROJO | 3000 | CREMA | 1015 | VERDE | 6002 |
| GRIS | 7035 | VERDE | 6005 | PLATA | |

FAMILIA 2512



REMACHE FLOR ALA ANCHA NEGRO

(ALUMINIO-INOX)

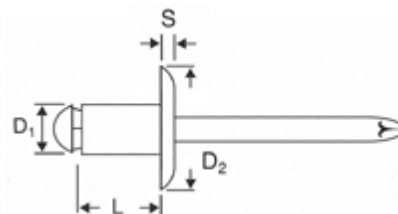

PEEL RIVET LARGE HEAD HEAD LACQUERED (ALUMINIUM-STAINLESS STEEL)

| CODIGO | BROCA Ø 4.5 D2:10 /S:1.2 REFERENCIA | MEDIDA 4 D1 x L | ESPESOR | EMBALAJE | |
|--------|---|-----------------------|-----------|----------|----------|
| | | | | INTERIOR | EXTERIOR |
| 00253 | 25123908 | 3,9 x 8 | 0,5-3,0 | 1.000 | 18.000 |
| 00254 | 25123910 | 3,9 x 10 | 3,0-5,0 | 500 | 9.000 |
| 00255 | 25123912 | 3,9 x 12 | 5,0-7,0 | 500 | 9.000 |
| 00256 | 25123914 | 3,9 x 14 | 7,0-9,0 | 500 | 9.000 |
| 00257 | 25123915 | 3,9 x 15 | 9,0-10,0 | 500 | 9.000 |
| 00258 | 25113916 | 3,9 x 16 | 10,0-11,0 | 500 | 9.000 |
| 00259 | 25123918 | 3,9 x 18 | 11,0-13,0 | 500 | 9.000 |
| 00260 | 25123920 | 3,9 x 20 | 13,0-15,0 | 500 | 9.000 |

| CODIGO | BROCA Ø 5.3 D2: 14 /S:1.4 REFERENCIA | MEDIDA 5 D1 x L | ESPESOR | EMBALAJE | |
|--------|--|-----------------------|-----------|----------|----------|
| | | | | INTERIOR | EXTERIOR |
| 00261 | 25124910 | 4,9 x 10 | 4,0-8,0 | 500 | 9.000 |
| 00262 | 25124912 | 4,9 x 12 | 6,0-8,0 | 500 | 9.000 |
| 00263 | 25124914 | 4,9 x 14 | 8,0-10,0 | 500 | 9.000 |
| 00264 | 25024915 | 4,9 x 15 | 10,0-11,0 | 500 | 9.000 |
| 00265 | 25124916 | 4,9 x 16 | 11,0-12,0 | 500 | 9.000 |
| 00266 | 25114918 | 4,9 x 18 | 12,0-14,0 | 500 | 9.000 |
| 00267 | 25124921 | 4,9 x 21 | 14,0-16,0 | 250 | 4.500 |
| 00268 | 25124924 | 4,9 x 24 | 16,0-18,0 | 250 | 4.500 |
| 00269 | 25124927 | 4,9 x 27 | 18,0-21,0 | 250 | 4.500 |
| 00270 | 25124930 | 4,9 x 30 | 21,0-25,0 | 250 | 4.500 |
| 00271 | 25124935 | 4,9 x 35 | 25,0-30,0 | 250 | 4.500 |



FABRICACION BAJO PEDIDO – CONSULTAR DISPONIBILIDAD

| COLOR | RAL | COLOR | RAL | COLOR | RAL |
|----------|------|---------|------|---------|------|
| AMARILLO | 1021 | MARRON | 8014 | BLANCO | 9010 |
| AZUL | 5010 | NARANJA | 2004 | NEGRO | 9005 |
| BRONCE | | ORO | | BURDEOS | 3004 |
| ROJO | 3000 | CREMA | 1015 | VERDE | 6002 |
| GRIS | 7035 | VERDE | 6005 | PLATA | |

FAMILIA 2520



REMACHE FLOR ALA SUPER (ALUMINIO-INOX)

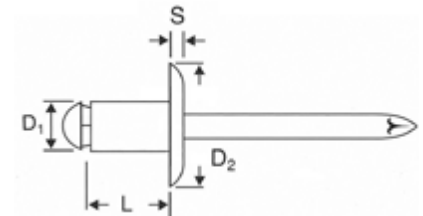

PEEL RIVET LARGE HEAD (ALUMINIUM-STAINLESS STEEL)

| CODIGO | BROCA Ø 5.3 D2: 14 /S:1.4 REFERENCIA | MEDIDA 5 D1 x L | ESPESOR | EMBALAJE | |
|--------|--|-----------------------|-----------|----------|----------|
| | | | | INTERIOR | EXTERIOR |
| 00280 | 25204910 | 4,9 x 10 | 4,0-8,0 | 500 | 9.000 |
| 00281 | 25204912 | 4,9 x 12 | 6,0-8,0 | 500 | 9.000 |
| 00282 | 25204914 | 4,9 x 14 | 8,0-10,0 | 500 | 9.000 |
| 00283 | 25204915 | 4,9 x 15 | 10,0-11,0 | 500 | 9.000 |
| 00284 | 25204916 | 4,9 x 16 | 11,0-12,0 | 500 | 9.000 |
| 00285 | 25204918 | 4,9 x 18 | 12,0-14,0 | 500 | 9.000 |
| 00286 | 25204921 | 4,9 x 21 | 14,0-16,0 | 250 | 4.500 |
| 00287 | 25204924 | 4,9 x 24 | 16,0-18,0 | 250 | 4.500 |
| 00288 | 25204927 | 4,9 x 27 | 18,0-21,0 | 250 | 4.500 |
| 00289 | 25204930 | 4,9 x 30 | 21,0-25,0 | 250 | 4.500 |
| 00290 | 25204935 | 4,9 x 35 | 25,0-30,0 | 250 | 4.500 |

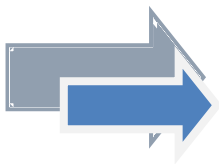

FABRICACION BAJO PEDIDO – CONSULTAR DISPONIBILIDAD

FAMILIA 2521



REMACHE FLOR ALA SUPER BLANCO

(ALUMINIO-INOX)

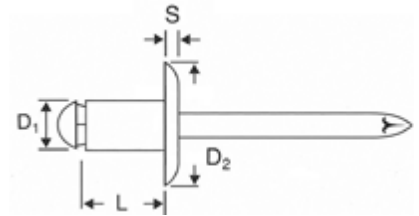

PEEL RIVET LARGE HEAD HEAD LACQUERED (ALUMINIUM-STAINLESS STEEL)

| CODIGO | BROCA ϕ 5.3 D2: 14 /S:1.4 REFERENCIA | MEDIDA 5 D1 x L | PRECIO €/1.000 | ESPESOR | EMBALAJE | |
|--------|---|-----------------------|-------------------|-----------|----------|----------|
| | | | | | INTERIOR | EXTERIOR |
| 00299 | 25214910 | 4,9 x 10 | | 4,0-8,0 | 500 | 9.000 |
| 00300 | 25214912 | 4,9 x 12 | | 6,0-8,0 | 500 | 9.000 |
| 00301 | 25214914 | 4,9 x 14 | | 8,0-10,0 | 500 | 9.000 |
| 00302 | 25214915 | 4,9 x 15 | | 10,0-11,0 | 500 | 9.000 |
| 00303 | 25214916 | 4,9 x 16 | | 11,0-12,0 | 500 | 9.000 |
| 00304 | 25214918 | 4,9 x 18 | | 12,0-14,0 | 500 | 9.000 |
| 00305 | 25214921 | 4,9 x 21 | | 14,0-16,0 | 250 | 4.500 |
| 00306 | 25214924 | 4,9 x 24 | | 16,0-18,0 | 250 | 4.500 |
| 00307 | 25214927 | 4,9 x 27 | | 18,0-21,0 | 250 | 4.500 |
| 00308 | 25214930 | 4,9 x 30 | | 21,0-25,0 | 250 | 4.500 |
| 00309 | 25214935 | 4,9 x 35 | | 25,0-30,0 | 250 | 4.500 |



FABRICACION BAJO PEDIDO – CONSULTAR DISPONIBILIDAD

| COLOR | RAL | COLOR | RAL | COLOR | RAL |
|----------|------|---------|------|---------|------|
| AMARILLO | 1021 | MARRON | 8014 | BLANCO | 9010 |
| AZUL | 5010 | NARANJA | 2004 | NEGRO | 9005 |
| BRONCE | | ORO | | BURDEOS | 3004 |
| ROJO | 3000 | CREMA | 1015 | VERDE | 6002 |
| GRIS | 7035 | VERDE | 6005 | PLATA | |

FAMILIA 2522



REMACHE FLOR ALA SUPER NEGRO

(ALUMINIO-INOX)

PEEL RIVET EXTRA LARGE HEAD HEAD LACQUERED

(ALUMINIUM-STAINLESS STEEL)

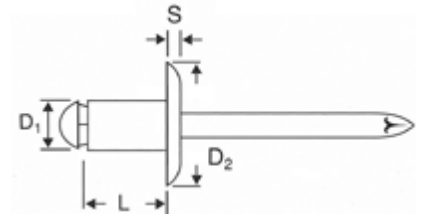

| CODIGO | BROCA Ø 5.5 D2:16 /S:1.4 REFERENCIA | MEDIDA 5 D1 x L | ESPESOR | EMBALAJE | |
|--------|---|-----------------------|-----------|----------|----------|
| | | | | INTERIOR | EXTERIOR |
| 00318 | 25224910 | 4,9 x 10 | 4,0-8,0 | 500 | 9.000 |
| 00319 | 25224912 | 4,9 x 12 | 6,0-8,0 | 500 | 9.000 |
| 00320 | 25224914 | 4,9 x 14 | 8,0-10,0 | 500 | 9.000 |
| 00321 | 25224915 | 4,9 x 15 | 10,0-11,0 | 500 | 9.000 |
| 00322 | 25224916 | 4,9 x 16 | 11,0-12,0 | 500 | 9.000 |
| 00323 | 25224918 | 4,9 x 18 | 12,0-14,0 | 500 | 9.000 |
| 00324 | 25224921 | 4,9 x 21 | 14,0-16,0 | 250 | 4.500 |
| 00325 | 25224924 | 4,9 x 24 | 16,0-18,0 | 250 | 4.500 |
| 00326 | 25224927 | 4,9 x 27 | 18,0-21,0 | 250 | 4.500 |
| 00327 | 25224930 | 4,9 x 30 | 21,0-25,0 | 250 | 4.500 |
| 00328 | 25224935 | 4,9 x 35 | 25,0-30,0 | 250 | 4.500 |



FABRICACION BAJO PEDIDO – CONSULTAR DISPONIBILIDAD

| COLOR | RAL | COLOR | RAL | COLOR | RAL |
|----------|------|---------|------|---------|------|
| AMARILLO | 1021 | MARRON | 8014 | BLANCO | 9010 |
| AZUL | 5010 | NARANJA | 2004 | NEGRO | 9005 |
| BRONCE | | ORO | | BURDEOS | 3004 |
| ROJO | 3000 | CREMA | 1015 | VERDE | 6002 |
| GRIS | 7035 | VERDE | 6005 | PLATA | |

FAMILIA 2300



REMACHE FLOR AVELLANADO (ALU/ACE)

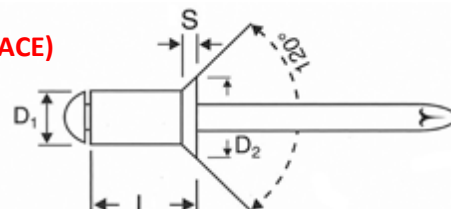

PEEL RIVET COUNTERSUNK HEAD (ALUMINIUM- STEEL)

| CODIGO | BROCA Ø4.5 D2:8 /S: REFERENCIA | MEDIDA 4 D1 x L | ESPESOR | EMBALAJE | |
|--------|--------------------------------------|-----------------------|-----------|----------|----------|
| | | | | INTERIOR | EXTERIOR |
| 00107 | 23003908 | 3,9 x 8 | 0,5-3,0 | 1.000 | 18.000 |
| 00108 | 23003910 | 3,9 x 10 | 3,0-5,0 | 500 | 9.000 |
| 00109 | 23003912 | 3,9 x 12 | 5,0-7,0 | 500 | 9.000 |
| 00110 | 23003914 | 3,9 x 14 | 7,0-9,0 | 500 | 9.000 |
| 00111 | 23003915 | 3,9 x 15 | 9,0-10,0 | 500 | 9.000 |
| 00112 | 23003916 | 3,9 x 16 | 10,0-11,0 | 500 | 9.000 |
| 00113 | 23003918 | 3,9 x 18 | 11,0-13,0 | 500 | 9.000 |
| 00114 | 23003920 | 3,9 x 20 | 13,0-15,0 | 500 | 9.000 |

| CODIGO | BROCA Ø5.5 D2:9.5 /S: REFERENCIA | MEDIDA 5 D1 x L | ESPESOR | EMBALAJE | |
|--------|--|-----------------------|-----------|----------|----------|
| | | | | INTERIOR | EXTERIOR |
| 00115 | 23004910 | 4,9 x 10 | 4,0-8,0 | 500 | 9.000 |
| 00116 | 23004912 | 4,9 x 12 | 6,0-8,0 | 500 | 9.000 |
| 00117 | 23004914 | 4,9 x 14 | 8,0-10,0 | 500 | 9.000 |
| 00118 | 23004915 | 4,9 x 15 | 10,0-11,0 | 500 | 9.000 |
| 00119 | 23004916 | 4,9 x 16 | 11,0-12,0 | 500 | 9.000 |
| 00120 | 23004918 | 4,9 x 18 | 12,0-14,0 | 500 | 9.000 |
| 00121 | 23004921 | 4,9 x 21 | 14,0-16,0 | 250 | 4.500 |
| 00122 | 23004924 | 4,9 x 24 | 16,0-18,0 | 250 | 4.500 |
| 00123 | 23004927 | 4,9 x 27 | 18,0-21,0 | 250 | 4.500 |
| 00124 | 23004930 | 4,9 x 30 | 21,0-25,0 | 250 | 4.500 |
| 00125 | 23004935 | 4,9 x 35 | 25,0-30,0 | 250 | 4.500 |

FABRICACION BAJO PEDIDO



CONSULTAR: LA MEDIDA Y EL COLOR QUE NECESITE

FAMILIA 2530



REMACHE FLOR AVELLANADO (ALUM.-INOX)

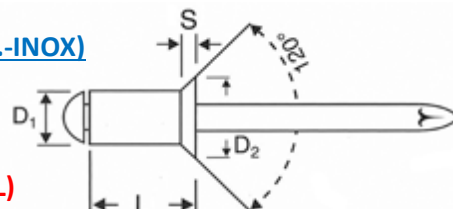

PEEL RIVET COUNTESUNK HEAD (ALUMINIUM-STAINLESS STEEL)

| CODIGO | BROCA Ø4.5 D2:8 /S: REFERENCIA | MEDIDA 4 D1 x L | ESPESOR | EMBALAJE | |
|--------|--------------------------------------|-----------------------|-----------|----------|----------|
| | | | | INTERIOR | EXTERIOR |
| 00329 | 25303908 | 3,9 x 8 | 0,5-3,0 | 1.000 | 18.000 |
| 00330 | 25303910 | 3,9 x 10 | 3,0-5,0 | 500 | 9.000 |
| 00331 | 25303912 | 3,9 x 12 | 5,0-7,0 | 500 | 9.000 |
| 00332 | 25303914 | 3,9 x 14 | 7,0-9,0 | 500 | 9.000 |
| 00333 | 25303915 | 3,9 x 15 | 9,0-10,0 | 500 | 9.000 |
| 00334 | 25303916 | 3,9 x 16 | 10,0-11,0 | 500 | 9.000 |
| 00335 | 25303918 | 3,9 x 18 | 11,0-13,0 | 500 | 9.000 |
| 00336 | 25303920 | 3,9 x 20 | 13,0-15,0 | 500 | 9.000 |

| CODIGO | BROCA Ø5.5 D2: 9.5 /S: REFERENCIA | MEDIDA 5 D1 x L | ESPESOR | EMBALAJE | |
|--------|---|-----------------------|-----------|----------|----------|
| | | | | INTERIOR | EXTERIOR |
| 00337 | 25304910 | 4,9 x 10 | 4,0-8,0 | 500 | 9.000 |
| 00338 | 25304912 | 4,9 x 12 | 6,0-8,0 | 500 | 9.000 |
| 00339 | 25304914 | 4,9 x 14 | 8,0-10,0 | 500 | 9.000 |
| 00340 | 25304915 | 4,9 x 15 | 10,0-11,0 | 500 | 9.000 |
| 00341 | 25304916 | 4,9 x 16 | 11,0-12,0 | 500 | 9.000 |
| 00342 | 25304918 | 4,9 x 18 | 12,0-14,0 | 500 | 9.000 |
| 00343 | 25304921 | 4,9 x 21 | 14,0-16,0 | 250 | 4.500 |
| 00344 | 25304924 | 4,9 x 24 | 16,0-18,0 | 250 | 4.500 |
| 00345 | 25304927 | 4,9 x 27 | 18,0-21,0 | 250 | 4.500 |
| 00346 | 25304930 | 4,9 x 30 | 21,0-25,0 | 250 | 4.500 |
| 00347 | 25304935 | 4,9 x 35 | 25,0-30,0 | 250 | 4.500 |



FABRICACION BAJO PEDIDO

CONSULTAR: LA MEDIDA Y EL COLOR QUE NECESITE

FAMILIA 3000

REMACHES MULTIGRIP (ALUMINIO-ACERO)

- RIVET MULTIGRIP ALU/STEEL

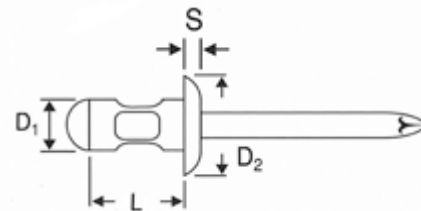

| CODIGO | BROCA Ø3.1 D2:6 /S:1.4 REFERENCIA | MEDIDA 3 D1 x L | ESPEJOR | EMBALAJE INTERIOR | EMBALAJE EXTERIOR. |
|--------|---|-----------------------|---------|----------------------|-----------------------|
| 23037 | 30003006 | 3 x 6 | 0,5-3,0 | 1.000 | 18.000 |
| 23038 | 30003008 | 3 x 8 | 0,5-5,0 | 1.000 | 18.000 |
| 23039 | 30003010 | 3 x 10 | 2,5-7,0 | 1.000 | 18.000 |
| 23040 | 30003012 | 3 x 12 | 4,5-9,0 | 1.000 | 18.000 |

| CODIGO | BROCA Ø3.3 D2: 6 /S:1.4 REFERENCIA | MEDIDA 3.2 D1 x L | ESPEJOR | EMBALAJE INTERIOR | EMBALAJE EXTERIOR |
|--------|--|-------------------------|----------|----------------------|----------------------|
| 23050 | 30003206 | 3.2 x 6 | 0,5-3,0 | 1.000 | 18.000 |
| 23003 | 30003208 | 3.2 x 8 | 0,5-5,0 | 1.000 | 18.000 |
| 53051 | 30003295 | 3.2 x 9.5 | 2,0-6,5 | 1.000 | 18.000 |
| 23052 | 30003210 | 3.2 x 10 | 2,5-7,0 | 1.000 | 18.000 |
| 23053 | 30003211 | 3.2 x 11 | 3,5-8,0 | 1.000 | 18.000 |
| 23054 | 30003212 | 3.2 x 12 | 4,5-9,0 | 1.000 | 18.000 |
| 23055 | 30003213 | 3.2 x 12.5 | 5,5-9,5 | 1.000 | 18.000 |
| 23056 | 30003214 | 3.2 x 14 | 6,5-11,0 | 1.000 | 18.000 |
| 23057 | 30003216 | 3.2 x 16 | 8,5-13,0 | 1.000 | 18.000 |

| CODIGO | BROCA Ø4.1 D2:8 /S:1.7 REFERENCIA | MEDIDA 4 D1 x L | ESPEJOR | EMBALAJE INTERIOR | EMBALAJE EXTERIOR |
|--------|---|-----------------------|-----------|----------------------|----------------------|
| 23041 | 30004006 | 4 x 6 | 0,5-2,5 | 1.000 | 18.000 |
| 23042 | 30004008 | 4 x 8 | 0,5-4,5 | 1.000 | 18.000 |
| 23043 | 30004095 | 4 x 9.5 | 1,0-6,0 | 1.000 | 18.000 |
| 23036 | 30004010 | 4 x 10 | 1,5-6,5 | 500 | 9.000 |
| 23044 | 30004012 | 4 x 12 | 3,5-8,5 | 500 | 9.000 |
| 23045 | 30004013 | 4 x 12.7 | 4,0-9,5 | 500 | 9.000 |
| 23046 | 30004014 | 4 x 14 | 5,5-10,5 | 500 | 9.000 |
| 23069 | 30004016 | 4 x 16 | 7,5-12,5 | 500 | 9.000 |
| 23047 | 30004017 | 4 x 17 | 8,5-13,5 | 500 | 9.000 |
| 23048 | 30004018 | 4 x 18 | 9,5-14,5 | 500 | 9.000 |
| 23049 | 30004020 | 4 x 20 | 11,5-16,5 | 500 | 9.000 |

MULTIGRIP (ALUMINIO-ACERO)

RIVET MULTIGRIP ALU/STEEL

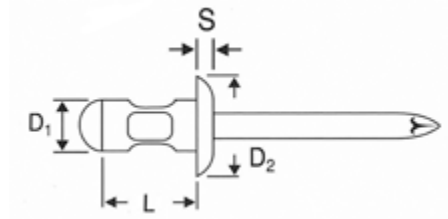

| CODIGO | BROCA Ø4.9 D2:9.5 /S:2 REFERENCIA | MEDIDA 4.8 D1 x L | ESPESOR | EMBALAJE INTERIOR | EMBALAJE EXTERIOR |
|--------|---|-------------------------|-----------|----------------------|----------------------|
| 23029 | 30004810 | 4.8 x 10 | 0,5-5,0 | 500 | 9.000 |
| 23058 | 30004811 | 4.8 x 10.3 | 0,5-5,5 | 500 | 9.000 |
| 23059 | 30004812 | 4.8 x 12 | 2,0-7,0 | 500 | 9.000 |
| 23060 | 30004814 | 4.8 x 14 | 4,0-9,0 | 500 | 9.000 |
| 23061 | 30004815 | 4.8 x 15.1 | 5,0-10,5 | 500 | 9.000 |
| 23062 | 30004816 | 4.8 x 16 | 6,0-11,0 | 500 | 9.000 |
| 23063 | 30004817 | 4.8 x 17 | 7,0-12,0 | 500 | 9.000 |
| 23064 | 30004818 | 4,8 x 18 | 8,0-13,0 | 500 | 9.000 |
| 23034 | 30004820 | 4.8 x 20 | 10,0-15,0 | 500 | 9.000 |
| 23065 | 30004822 | 4.8 x 22 | 12,0-17,0 | 500 | 9.000 |
| 23066 | 30004824 | 4.8 x 24 | 14,0-19,0 | 500 | 9.000 |
| 23035 | 30004825 | 4.8 x 24.8 | 14,5-19,5 | 500 | 9.000 |

FAMILIA 3100

MULTIGRIP (ALUMINIO-ACERO) ALA ANCHA

RIVET MULTIGRIP LARGE HEAD

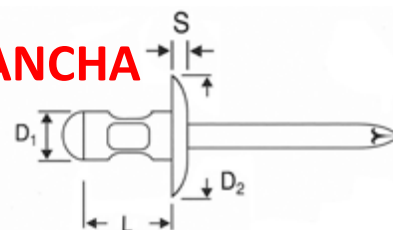

| CODIGO | BROCA Ø3.3 D2:9.5 /S:2 REFERENCIA | MEDIDA 3.2 D1 x L | ESPEJOR | EMBALAJE INTERIOR | EMBALAJE EXTERIOR |
|--------|--|-------------------------|----------|----------------------|----------------------|
| 23234 | 31003208 | 3.2 x 8 | 0,5-5,0 | 1.000 | 18.000 |
| 23235 | 31003295 | 3.2 x 9.5 | 2,0-6,5 | 1.000 | 18.000 |
| 23236 | 31003210 | 3.2 x 10 | 2,5-7,0 | 1.000 | 18.000 |
| 23237 | 31003211 | 3.2 x 11.1 | 3,5-8,0 | 1.000 | 18.000 |
| 23238 | 31003212 | 3.2 x 12 | 4,5-9,0 | 1.000 | 18.000 |
| 23239 | 31003214 | 3.2 x 14 | 6,5-11,0 | 1.000 | 18.000 |
| 23240 | 31003216 | 3.2 x 16 | 8,5-13,0 | 1.000 | 18.000 |

| CODIGO | BROCA Ø4.1 D2:12 /S:2.5 REFERENCIA | MEDIDA 4 D1 x L | ESPEJOR | EMBALAJE INTERIOR | EMBALAJE EXTERIOR |
|--------|---|-----------------------|-----------|----------------------|----------------------|
| 23241 | 31004008 | 4 x 8 | 0,5-4,5 | 500 | 9.000 |
| 23242 | 31004010 | 4 x 10 | 1,5-6,5 | 500 | 9.000 |
| 23243 | 31004011 | 4 x 11.1 | 2,5-7,5 | 500 | 9.000 |
| 23244 | 31004012 | 4 x 12 | 3,5-8,5 | 500 | 9.000 |
| 23245 | 31004013 | 4 x 12.7 | 4,0-9,5 | 500 | 9.000 |
| 23246 | 31004014 | 4 x 14 | 5,5-10,5 | 500 | 9.000 |
| 23247 | 31004016 | 4 x 16 | 7,5-12,5 | 500 | 9.000 |
| 23248 | 31004017 | 4 x 17 | 8,5-13,5 | 500 | 9.000 |
| 23249 | 31004018 | 4 x 18 | 9,5-14,5 | 500 | 9.000 |
| 23250 | 31004020 | 4 x 20 | 11,5-16,5 | 500 | 9.000 |

| CODIGO | BROCA Ø4.9 D2:14 /S:2.5 REFERENCIA | MEDIDA 4.8 D1 x L | EXPEJOR | EMBALAJE INTERIOR | EMBALAJE EXTERIOR |
|--------|--|-------------------------|-----------|----------------------|----------------------|
| 23251 | 31004810 | 4.8 x 10 | 0,5-5,0 | 500 | 9.000 |
| 23252 | 31004812 | 4.8 x 12 | 2,0-7,0 | 500 | 9.000 |
| 23253 | 31004814 | 4.8 x 14 | 4,0-9,0 | 500 | 9.000 |
| 23254 | 31004816 | 4.8 x 16 | 6,0-11,0 | 500 | 9.000 |
| 23233 | 31004818 | 4,8 x 18 | 8,0-13,0 | 500 | 9.000 |
| 23255 | 31004820 | 4.8 x 20 | 10,0-15,0 | 250 | 4.500 |

FAMILIA 3200

MULTIGRIP (ALUMINIO-ACERO) ALA SUPER

RIVET MULTIGRIP EXTRA LARGE HEAD

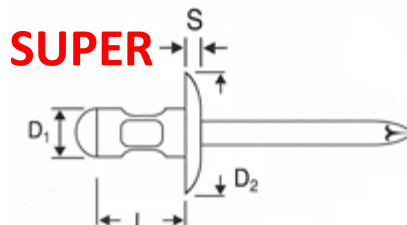

| CODIGO | BROCA Ø4.9 D2:16 /S:2.5 REFERENCIA | MEDIDA 4.8 D1 x L | ESPESOR | EMBALAJE INTERIOR | EMBALAJE EXTERIOR |
|--------|--|-------------------------|-----------|----------------------|----------------------|
| 23136 | 32004810 | 4.8 x 10 | 0,5-5,0 | 500 | 9.000 |
| 23137 | 32004811 | 4.8 x 10.5 | 0,5-5,5 | 500 | 9.000 |
| 23138 | 32004812 | 4.8 x 12 | 2,0-7,0 | 500 | 9.000 |
| 23139 | 32004814 | 4.8 x 14 | 4,0-9,0 | 500 | 9.000 |
| 23140 | 32004816 | 4.8 x 16 | 6,0-11,0 | 500 | 9.000 |
| 23141 | 32004817 | 4.8 x 17 | 7,0-12,0 | 500 | 9.000 |
| 23142 | 32004818 | 4,8 x 18 | 8,0-13,0 | 500 | 9.000 |
| 23143 | 32004820 | 4.8 x 20 | 10,0-15,0 | 250 | 4.500 |
| 23144 | 32004822 | 4.8 x 22 | 12,0-17,0 | 250 | 4.500 |
| 23145 | 32004824 | 4.8 x 24 | 14,0-19,0 | 250 | 4.500 |
| 23135 | 32004825 | 4.8 x 24.8 | 14,5-19,5 | 250 | 4.500 |
| 23146 | 32004827 | 4.8 x 27 | 16,0-22,0 | 250 | 4.500 |

CONSULTAR:

FAMILIA 3001 REM.MULTIGRIP LC.BLANCO

FAMILIA 3002 REM.MULTIGRIP LC.NEGRO

FAMILIA 3101 REM.MULTIGRIP ALA ANCHA BLANCO

FAMILIA 3102 REM.MULTIGRIP ALA ANCHA NEGRO

FAMILIA 3201 REM.MULTIGRIP ALA SUPER BLANCO

FAMILIA 3202 REM.MULTIGRIP ALA SUPER NEGRO

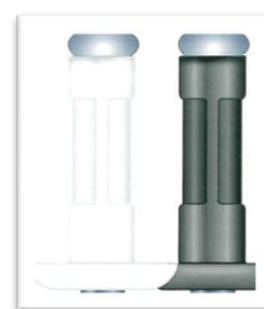

CONSULTAR: LA MEDIDA Y EL COLOR QUE NECESITE.

FAMILIA 4000

TREBOL ALUMINIO- ALUMINIO

TREBOL RIVET

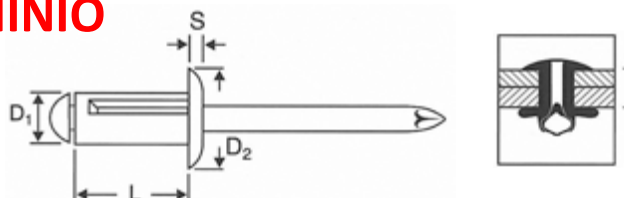

| CODIGO | BROCA Ø4.25 D2:8 /S:1.4 REFERENCIA | MEDIDA 4 D1 x L | EXPESOR | EMBALAJE INTERIOR | EMBALAJE EXTERIOR |
|--------|--|-----------------------|---------|----------------------|----------------------|
| 90200 | 40004014 | 4 x 13.6 | 1,0-3,0 | 500 | 9.000 |
| 90201 | 40004019 | 4 x 18.8 | 3,0-7,0 | 500 | 9.000 |

| CODIGO | BROCA Ø5 D2:9.6 /S:1.6 REFERENCIA | MEDIDA 4.8 D1 x L | EXPESOR | EMBALAJE INTERIOR | EMBALAJE EXTERIOR |
|--------|---|-------------------------|----------|----------------------|----------------------|
| 90202 | 40004815 | 4.8 x 15.3 | 1,0-3,0 | 500 | 9.000 |
| 90203 | 40004820 | 4.8 x 20.5 | 3,0-9,0 | 250 | 4.500 |
| 90204 | 40004824 | 4.8 x 24.5 | 5,0-12,0 | 250 | 4.500 |

FAMILIA 4001

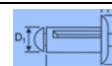

TREBOL ALUMINIO- ALUMINIO LC. BLANCO

TREBOL LACQUERED RIVET

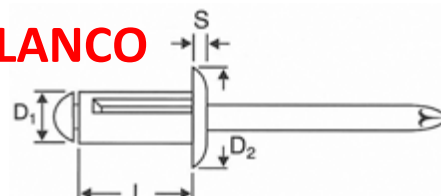

| CODIGO | BROCA Ø4.25 D2:8 /S:1.4 REFERENCIA | MEDIDA 4 D1 x L | ESPESOR | EMBALAJE INTERIOR | EMBALAJE EXTERIOR |
|--------|--|-----------------------|---------|----------------------|----------------------|
| 00596 | 40014014 | 4 x 13.6 | 1,0-3,0 | 500 | 9.000 |
| 00597 | 40014019 | 4 x 18.8 | 3,0-7,0 | 500 | 9.000 |

| CODIGO | BROCA Ø5 D2:9.6 /S:1.6 REFERENCIA | MEDIDA 4.8 D1 x L | ESPESOR | EMBALAJE INTERIOR | EMBALAJE EXTERIOR |
|--------|---|-------------------------|----------|----------------------|----------------------|
| 00598 | 40014815 | 4.8 x 15.3 | 1,0-3,0 | 500 | 9.000 |
| 00599 | 40014820 | 4.8 x 20.5 | 3,0-9,0 | 250 | 4.500 |
| 00600 | 40014824 | 4.8 x 24.5 | 5,0-12,0 | 250 | 4.500 |

FAMILIA 4002

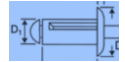

TREBOL ALUMINIO- ALUMINIO LC.NEGRO

TREBOL LACQUERED RIVET

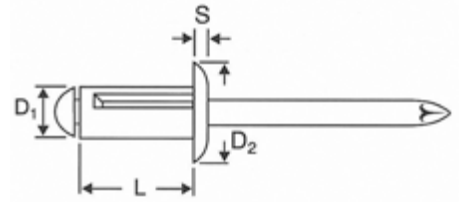

| CODIGO | BROCA Ø4.25 D2:8 /S:1.4 REFERENCIA | MEDIDA 4 D1 x L | ESPESOR | EMBALAJE INTERIOR | EMBALAJE EXTERIOR |
|--------|--|-----------------------|---------|----------------------|----------------------|
| 00601 | 40024014 | 4 x 13.6 | 1,0-3,0 | 500 | 9.000 |
| 00602 | 40024019 | 4 x 18.8 | 3,0-7,0 | 500 | 9.000 |

| CODIGO | BROCA Ø5 D2:9.6 /S:1.6 REFERENCIA | MEDIDA 4.8 D1 x L | EXPESOR | EMBALAJE INTERIOR | EMBALAJE EXTERIOR |
|--------|---|-------------------------|----------|----------------------|----------------------|
| 00603 | 40024815 | 4.8 x 15.3 | 1,0-3,0 | 500 | 9.000 |
| 00604 | 40024820 | 4.8 x 20.5 | 3,0-9,0 | 250 | 4.500 |
| 00605 | 40024824 | 4.8 x 24.5 | 5,0-12,0 | 250 | 4.500 |

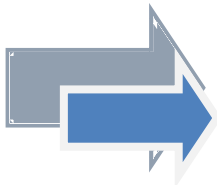

CONSULTAR: LA MEDIDA Y EL COLOR QUE NECESITE.

| COLOR | RAL | COLOR | RAL | COLOR | RAL |
|----------|------|---------|------|---------|------|
| AMARILLO | 1021 | MARRON | 8014 | BLANCO | 9010 |
| AZUL | 5010 | NARANJA | 2004 | NEGRO | 9005 |
| BRONCE | | ORO | | BURDEOS | 3004 |
| ROJO | 3000 | CREMA | 1015 | VERDE | 6002 |
| GRIS | 7035 | VERDE | 6005 | PLATA | |

FABRICACION BAJO PEDIDO

FAMILIA 6000

REMACHES DE GOLPE ALUMINIO-INOX CABEZA SUPER GRANDE Ø 16 -

RIVET TYPE STROKE ALA EXTRA WIDE ALUMINIUM HEAD / STAINLESS STEEL



| CODIGO | BROCA Ø4.9 D2:14.5 /S:2.2 REFERENCIA | MEDIDA 4,8 D1 x L | ESPEJOR Max. | EMBALAJE INTERIOR | EMBALAJE EXTERIOR |
|--------|--|-------------------------|-----------------|----------------------|----------------------|
| 91028 | 60004809 | 4.8 x 9 | 4.5-7.0 | 500 | 9.000 |
| 91029 | 60004811 | 4.8 x 11 | 6.5-9.5 | 500 | 9.000 |
| 91032 | 60004816 | 4.8 x 16 | 11.5-13.0 | 250 | 4.500 |
| 91034 | 60004820 | 4.8 x 20 | 15.5-17.0 | 250 | 4.500 |
| 91035 | 60004825 | 4.8 x 25 | 20.5-22.0 | 250 | 4.500 |
| 91037 | 60004830 | 4.8 x 30 | 25.5-27.0 | 250 | 4.500 |
| 91038 | 60004835 | 4,8 x 35 | 30.5-32.0 | 250 | 4.500 |
| 91039 | 60004840 | 4.8 x 40 | 35.5-37.0 | 200 | 3.600 |
| 91040 | 60004845 | 4.8 x 45 | 40.5-42.0 | 200 | 3.600 |
| 91041 | 60004850 | 4.8 x 50 | 45.5-47.0 | 200 | 3.600 |

ESTRUCTURAL

REMACHES DE ALTA RESITENCIA.

VENTAJAS: EVITA LAS VIBRACIONES, CAPACIDAD DE RELLENO – COMPENSA EL SOBREDIMENSIONADO O LA ALINEACION DEL AGUJERO.

APLICACIONES: ind. Automovilística, electrónica, construcción....

FAMILIA 5000

REMACHE ESTRUCTURAL TRIFORME ALU/ALU

RIVET STRUCTURAL TRIFORM ALU/ALU

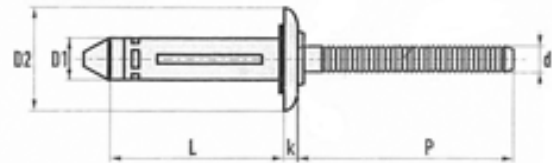

| CODIGO | BROCA Ø5.25 D2:11.7 /S:2.2 REFERENCIA | MEDIDA 5.2 D1 x L | ESPESOR | EMBALAJE | |
|--------|---|-------------------------|-----------|----------|----------|
| | | | | INTERIOR | EXTERIOR |
| 00860 | 50005217 | 5,2x17,5 | 0.5-4.8 | 250 | 4.500 |
| 00861 | 50005219 | 5,2x19 | 1.5-6.4 | 250 | 4.500 |
| 00862 | 50005222 | 5,2x22 | 4.8-9.5 | 250 | 4.500 |
| 00863 | 50005225 | 5,2x25 | 7.9-12.7 | 250 | 4.500 |
| 00864 | 50005229 | 5,2x29 | 11.1-15.9 | 250 | 4.500 |
| 00865 | 50005232 | 5,2x32 | 14.3-19.1 | 250 | 4.500 |

FAMILIA 5100

REMACHE ESTRUCTURAL MULTGRIP ACERO

RIVET STRUCTURAL MULTIGRIP STEEL

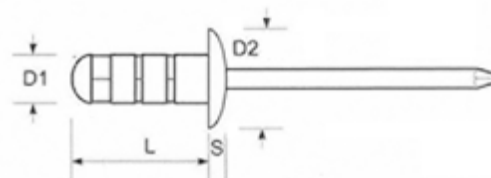

| CODIGO | BROCA Ø3.3 D2:6.5 /S:1.1 | MEDIDA 3.2 | ESPESOR | EMBALAJE | |
|--------|-----------------------------|---------------|---------|----------|----------|
| | REFERENCIA | D1 x L | | INTERIOR | EXTERIOR |
| 00866 | 51003290 | 3,2x9 | 1.0-3.0 | 1.000 | 18.000 |
| 00867 | 51003211 | 3,2x11 | 3.0-5.0 | 1.000 | 18.000 |
| 00868 | 51003214 | 3,2x14 | 5.0-7.0 | 1.000 | 18.000 |

| CODIGO | BROCA Ø4.1 D2:8.1 /S:1.2 | MEDIDA 4 | ESPESOR | EMBALAJE | |
|--------|-----------------------------|-------------|---------|----------|----------|
| | REFERENCIA | D1 x L | | INTERIOR | EXTERIOR |
| 00869 | 51004010 | 4x10 | 1.0-3.0 | 500 | 9.000 |
| 00870 | 51004012 | 4x12 | 3.0-5.0 | 500 | 9.000 |
| 00871 | 51004015 | 4x15 | 5.0-7.0 | 500 | 9.000 |

| CODIGO | BROCA Ø4.9 D2:9.5 /S:1.5 | MEDIDA 4.8 | ESPESOR | EMBALAJE | |
|--------|-----------------------------|---------------|---------|----------|----------|
| | REFERENCIA | D1 x L | | INTERIOR | EXTERIOR |
| 00872 | 51004812 | 4,8x12 | 1.5-3.5 | 500 | 9.000 |
| 00873 | 51004816 | 4,8x15,5 | 3.5-6.0 | 500 | 9.000 |
| 00874 | 51004818 | 4,8x18 | 6.0-8.5 | 500 | 9.000 |

| CODIGO | BROCA Ø6.1 D2:12 /S:1.95 | MEDIDA 6 | ESPESOR | EMBALAJE | |
|--------|-----------------------------|-------------|----------|----------|----------|
| | REFERENCIA | D1 x L | | INTERIOR | EXTERIOR |
| 00875 | 51006014 | 6x14 | 1.5-4.0 | 250 | 4.500 |
| 00876 | 51006017 | 6x17 | 3.0-6.0 | 250 | 4.500 |
| 00877 | 51006020 | 6x20 | 6.0-9.0 | 250 | 4.500 |
| 00878 | 51006023 | 6x23 | 9.0-12.0 | 250 | 4.500 |

FAMILIA 5110

REMACHE ESTRUCTURAL MULTGRIP INOX A2

RIVET STRUCTURAL MULTIGRIP STAINLESS STEEL

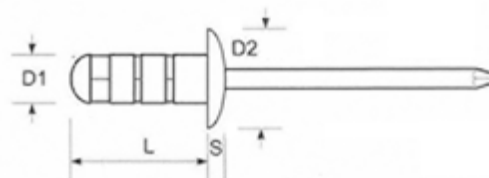

| CODIGO | BROCA Ø3.3 | MEDIDA | ESPEJOR | EMBALAJE | |
|--------|---------------|--------|---------|----------|----------|
| | D2:6.5 /S:1.1 | 3.2 | | INTERIOR | EXTERIOR |
| | REFERENCIA | D1 x L | | | |
| 00879 | 51103290 | 3,2x9 | 1.0-3.0 | 1.000 | 18.000 |
| 00880 | 51103211 | 3,2x11 | 3.0-5.0 | 1.000 | 18.000 |
| 00881 | 51103214 | 3,2x14 | 5.0-7.0 | 1.000 | 18.000 |

| CODIGO | BROCA Ø4.1 | MEDIDA | ESPEJOR | EMBALAJE | |
|--------|---------------|--------|---------|----------|----------|
| | D2:8.1 /S:1.2 | 4 | | INTERIOR | EXTERIOR |
| | REFERENCIA | D1 x L | | | |
| 00882 | 51104010 | 4x10 | 1.0-3.0 | 500 | 9.000 |
| 00883 | 51104013 | 4x12,5 | 3.0-5.0 | 500 | 9.000 |
| 00884 | 51104015 | 4x15 | 5.0-7.0 | 500 | 9.000 |

| CODIGO | BROCA Ø4.9 | MEDIDA | ESPEJOR | EMBALAJE | |
|--------|---------------|----------|---------|----------|----------|
| | D2:9.5 /S:1.5 | 4.8 | | INTERIOR | EXTERIOR |
| | REFERENCIA | D1 x L | | | |
| 00885 | 51104813 | 4,8x13 | 1.5-3.5 | 500 | 9.000 |
| 00886 | 51104815 | 4,8x15 | 3.5-6.0 | 500 | 9.000 |
| 00887 | 51104818 | 4,8x18,5 | 6.0-8.5 | 500 | 9.000 |

FAMILIA 5200

REMACHE ESTRUCTURAL ACERO

RIVET STRUCTURAL STEEL

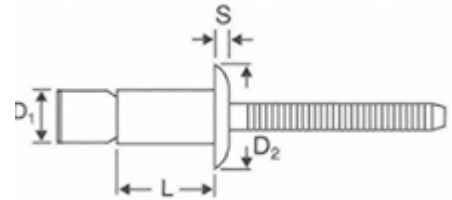

| CODIGO | BROCA Ø4.9 D2:10 /S:2.2 REFERENCIA | MEDIDA 4.8 D1 x L | ESPESOR | EMBALAJE | |
|--------|--|-------------------------|----------|----------|----------|
| | | | | INTERIOR | EXTERIOR |
| 00888 | 52004810 | 4,8x10 | 1.6-6.9 | 500 | 9.000 |
| 00889 | 52004814 | 4,8x14 | 1.6-11.0 | 500 | 9.000 |

| CODIGO | BROCA Ø6.6 D2:13.5 /S:3 REFERENCIA | MEDIDA 6 D1 x L | ESPESOR | EMBALAJE | |
|--------|--|-----------------------|----------|----------|----------|
| | | | | INTERIOR | EXTERIOR |
| 24050 | 52006414 | 6,4x14 | 2.0-9.5 | 250 | 4.500 |
| 24039 | 52006420 | 6,4x20 | 2.0-15.9 | 250 | 4.500 |

FAMILIA 5210

REMACHE ESTRUCTURAL ACERO CAB.AVELLANADA

RIVET STRUCTURAL STEEL COUNTERSUNK HEAD

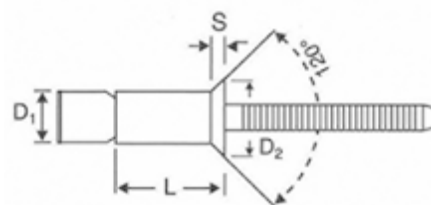

| CODIGO | BROCA Ø4.9 D2:9 /S:2.2 REFERENCIA | MEDIDA 4.8 D1 x L | ESPESOR | EMBALAJE | |
|--------|---|-------------------------|----------|----------|----------|
| | | | | INTERIOR | EXTERIOR |
| 00890 | 52104813 | 4,8x13 | 3.2-8.4 | 500 | 9.000 |
| 00891 | 52104817 | 4,8x17 | 7.7-12.7 | 500 | 9.000 |

| CODIGO | BROCA Ø6.6 D2:10.5 /S:2.4 REFERENCIA | MEDIDA 6.4 D1 x L | ESPESOR | EMBALAJE | |
|--------|--|-------------------------|-----------|----------|----------|
| | | | | INTERIOR | EXTERIOR |
| 00892 | 52106417 | 6,4x17 | 4.1-12.1 | 250 | 4.500 |
| 00893 | 52106423 | 6,4x23,5 | 10.5-18.4 | 250 | 4.500 |

FAMILIA 5220

REMACHE ESTRUCTURAL ALUMINIO

RIVET STRUCTURAL ALUMINIUM

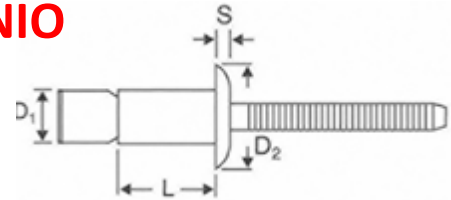

| CODIGO | BROCA Ø4.9 | MEDIDA | ESPESOR | EMBALAJE | |
|--------|--------------|--------|----------|----------|----------|
| | D2:10 /S:2.2 | 4.8 | | INTERIOR | EXTERIOR |
| | REFERENCIA | D1 x L | | | |
| 00894 | 52204810 | 4,8x10 | 1.6-6.9 | 500 | 9.000 |
| 00895 | 52204814 | 4,8x14 | 1.6-11.0 | 500 | 9.000 |

| CODIGO | BROCA Ø6.6 | MEDIDA | ESPESOR | EMBALAJE | |
|--------|--------------|--------|----------|----------|----------|
| | D2:13.5 /S:3 | 6 | | INTERIOR | EXTERIOR |
| | REFERENCIA | D1 x L | | | |
| 00896 | 52206414 | 6,4x14 | 2.0-9.5 | 250 | 4.500 |
| 00897 | 52206420 | 6,4x20 | 2.0-15.9 | 250 | 4.500 |

FAMILIA 5230

REMACHE ESTRUCTURAL ALUMINIO

CAB.AVELLANADA

RIVET STRUCTURAL ALUMINIUM COUNTERSUNK HEAD

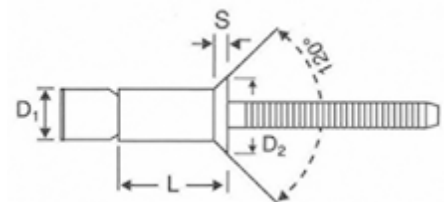

| CODIGO | BROCA Ø4.9 | MEDIDA | ESPESOR | EMBALAJE | |
|--------|--------------|--------|----------|----------|----------|
| | D2:10 /S:2.2 | 4.8 | | INTERIOR | EXTERIOR |
| | REFERENCIA | D1 x L | | | |
| 00898 | 52304813 | 4,8x13 | 3.2-8.4 | 500 | 9.000 |
| 00899 | 52304817 | 4,8x17 | 7.7-12.7 | 500 | 9.000 |

| CODIGO | BROCA Ø6.6 | MEDIDA | ESPESOR | EMBALAJE | |
|--------|------------------|----------|-----------|----------|----------|
| | D2:10.5.5 /S:2.4 | 6.4 | | INTERIOR | EXTERIOR |
| | REFERENCIA | D1 x L | | | |
| 00900 | 52306417 | 6,4x17 | 4.1-12.1 | 250 | 4.500 |
| 00901 | 52306423 | 6,4x23,5 | 10.5-18.4 | 250 | 4.500 |

FAMILIA 5240

REMACHE ESTRUCTURAL INOX A2

RIVET STRUCTURAL ATAINLESS STEEL

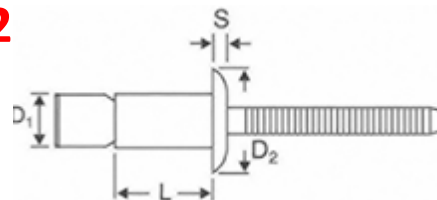

| CODIGO | BROCA Ø4.9 | MEDIDA | ESPESOR | EMBALAJE | |
|--------|--------------|--------|----------|----------|----------|
| | D2:10 /S:2.2 | 4.8 | | INTERIOR | EXTERIOR |
| | REFERENCIA | D1 x L | | | |
| 00902 | 52404810 | 4,8x10 | 1.6-6.9 | 500 | 9.000 |
| 00903 | 52404814 | 4,8x14 | 1.6-11.0 | 500 | 9.000 |

| CODIGO | BROCA Ø6.6 | MEDIDA | ESPESOR | EMBALAJE | |
|--------|--------------|--------|----------|----------|----------|
| | D2:13.5 /S:3 | 6.4 | | INTERIOR | EXTERIOR |
| | REFERENCIA | D1 x L | | | |
| 00904 | 52406414 | 6,4x14 | 2.0-9.5 | 250 | 4.500 |
| 00905 | 52406420 | 6,4x20 | 2.0-15.9 | 250 | 4.500 |

FAMILIA 5250

REMACHE ESTRUCTURAL INOX A2 CAB.AVELLANADA

RIVET STRUCTURAL STAINLESS STEEL COUNTERSUNK HEAD

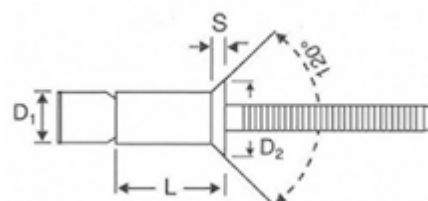

| CODIGO | BROCA Ø4.9 | MEDIDA | ESPESOR | EMBALAJE | |
|--------|--------------|--------|----------|----------|----------|
| | D2:10 /S:2.2 | 4.8 | | INTERIOR | EXTERIOR |
| | REFERENCIA | D1 x L | | | |
| 00906 | 52504813 | 4,8x13 | 3.2-8.4 | 500 | 9.000 |
| 00907 | 52504817 | 4,8x17 | 7.7-12.7 | 500 | 9.000 |

| CODIGO | BROCA Ø6.6 | MEDIDA | ESPESOR | EMBALAJE | |
|--------|------------------|----------|-----------|----------|----------|
| | D2:10.5.5 /S:2.4 | 6.4 | | INTERIOR | EXTERIOR |
| | REFERENCIA | D1 x L | | | |
| 00908 | 52506417 | 6,4x17 | 4.1-12.1 | 250 | 4.500 |
| 00909 | 52506423 | 6,4x23,5 | 10.5-18.4 | 250 | 4.500 |

FAMILIA 5300

REMACHE ESTRUCTURAL ACERO -1

RIVET STRUCTURAL STEEL - 1

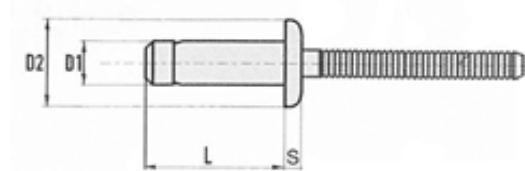

| CODIGO | BROCA Ø6.7 D2:13.5 /S:3 REFERENCIA | MEDIDA 6.4 D1 x L | ESPESOR | EMBALAJE | |
|--------|--|-------------------------|-----------|----------|----------|
| | | | | INTERIOR | EXTERIOR |
| 00910 | 53006410 | 6,4x10,5 | 2.8-4.8 | 250 | 4.500 |
| 00911 | 53006412 | 6,4x12,5 | 4.8-6.8 | 250 | 4.500 |
| 00912 | 53006414 | 6,4x14,5 | 6.8-8.8 | 250 | 4.500 |
| 00913 | 53006416 | 6,4x16,5 | 8.8-10.8 | 250 | 4.500 |
| 00914 | 53006418 | 6,4x18,5 | 10.8-12.8 | 250 | 4.500 |
| 00915 | 53006420 | 6,4x20,5 | 12.8-14.8 | 250 | 4.500 |

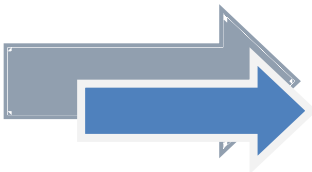

EN Ø 4.8
ACERO CAB. AVELLANADA
ALUMINIO
ALUMINIO CAB. AVELLANADA
INOX

EXPOSITORES



CODIGO 00001

| MEDIDAS | CANTIDAD | CANT.TOTAL |
|---------------------|----------|------------|
| 2.9 x 6 alu. (40) | 30 | 1.200 |
| 2.9 x 8 alu. (40) | 30 | 1.200 |
| 2.9 x 10 alu. (40) | 30 | .200 |
| 2.9 x 15 alu. (40) | 30 | 1.200 |
| 3.9 x 6 alu. (30) | 30 | 900 |
| 3.9 x 8 alu. (30) | 30 | 900 |
| 3.9 x 10 alu. (30) | 30 | 900 |
| 3.9 x 12 alu. (30) | 30 | 900 |
| 3.9 x 15 alu. (30) | 30 | 900 |
| 3.9 x 18 alu. (30) | 30 | 900 |
| 3.9 x 20 alu. (30) | 30 | 900 |
| 4.9 x 8 alu. (20) | 30 | 600 |
| 4.9 x 10 alu. (20) | 30 | 600 |
| 4.9 x 15 alu. (20) | 30 | 600 |
| 4.9 x 18 alu. (20) | 30 | 600 |
| 4.9 x 21 alu. (20) | 30 | 600 |
| 4.9 x 24 alu. (20) | 30 | 600 |
| 4.9 x35 alu. (20) | 30 | 600 |
| 4.9 x 40 alu. (20) | 30 | 600 |
| 3.9 x10 flor (30) | 30 | 900 |
| 4.9 x 12 flor (20) | 30 | 600 |
| C4 remachadora | 5 | 5 |
| R6 remachadora | 5 | 5 |
| 3.9 x 10 alu. (105) | 30 | 3.150 |
| 3.9 x 12 alu. (105) | 30 | 3.150 |
| 3.9 x 15 alu (105) | 30 | 3.150 |
| 4.9 x 10 alu. (105) | 30 | 3.150 |
| 4.9 x 12 alu. (105) | 30 | 3.150 |
| 4.9 x 15 alu. (105) | 30 | 3.150 |

EXPOSITOR DE SOBREMESA

CONSULTAR COMPOSICIONES:

REM.STANDARD

REM.CABEZA GRANDE / REM.CABEZA SUPER GRANDE

REM.LACADO

REM.FLOR



BLISTER



BLISTER PEQUEÑO
MINI BLISTER
SMALL PACK

BLISTER GRANDE
GRAND BLISTER
BIG PACK

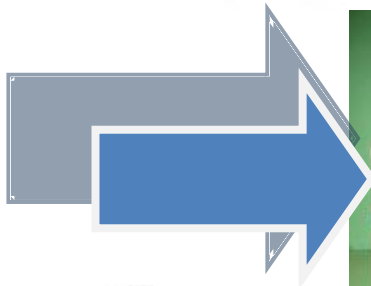
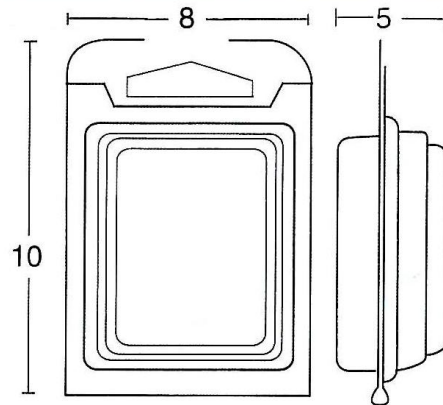
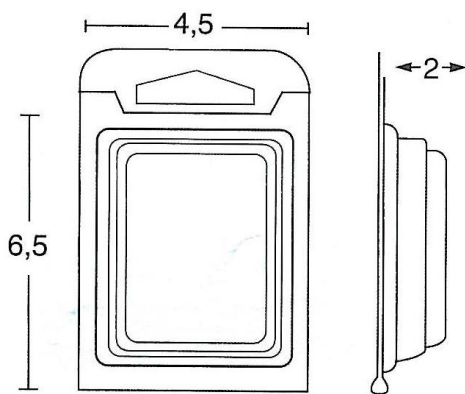

BLISTER REMACHES ACERO

BLISTER REMACHES LACADOS

BLISTER REMACHES AVELLANADOS

BLISTER TORNILLERIA (DIN 660,661,96,97 934,985,912...

BLISTER TUERCAS REMACHABLES

BLISTER GRANDE REMACHE ESTANDAR

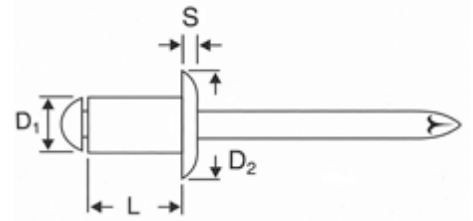

| CODIGO | REFERENCIA ∅ 3.2 mm. D2 = 6.5 mm. S = 1.0 mm | 3.2 D1 x L | ESPEJOR A REMACHAR | CONTENIDO BLISTER |
|--------|---|---------------|-----------------------|----------------------|
| 30203 | 100093206 | 3,2 x 6 | 1.5 – 3.5 | 100 |
| 30204 | 100093208 | 3,2 x 8 | 3.5 – 5.5 | 100 |
| 30205 | 100093210 | 3,2 x 10 | 5.5 – 7.0 | 100 |
| 30206 | 100093212 | 3,2 x 12 | 7.0 – 9.0 | 100 |
| 30207 | 100093215 | 3,2 x 15 | 9.0 – 12.0 | 100 |
| 30208 | 100093215 | 3,2 x 18 | 12.0 – 15.0 | 100 |

| CODIGO | REFERENCIA ∅ 4 mm. D2 = 8.1 mm. S = 1.2 mm. | 4 D1 x L | ESPEJOR A REMACHAR | CONTENIDO BLISTER |
|--------|--|-------------|-----------------------|----------------------|
| 30209 | 100093906 | 3,9 x 6 | 0.5 – 2.0 | 75 |
| 30210 | 100093908 | 3,9 x 8 | 2.0 – 4.0 | 75 |
| 30211 | 100093910 | 3,9 x 10 | 4.0 – 6.0 | 75 |
| 30212 | 100093912 | 3,9 x 12 | 6.0 – 8.0 | 75 |
| 30214 | 100093914 | 3,9 x 14 | 8.0 – 10.0 | 75 |
| 30215 | 100093916 | 3,9 x 16 | 10.0 – 12.0 | 75 |
| 30216 | 100093918 | 3,9 x 18 | 12.0 – 14.0 | 75 |
| 30217 | 100093920 | 3,9 x 20 | 14.0 – 16.0 | 75 |

| CODIGO | REFERENCIA ∅ 5 mm. D2 = 9.1 mm. S = 1.4 mm. | 5 D1 x L | ESPEJOR A REMACHAR | CONTENIDO BLISTER |
|--------|--|-------------|-----------------------|----------------------|
| 30228 | 100094906 | 4,9 x 6 | 0.5 – 2.0 | 50 |
| 30229 | 100094908 | 4,9 x 8 | 2.0 – 3.5 | 50 |
| 30230 | 100094910 | 4,9 x 10 | 4.0 – 6.0 | 50 |
| 30232 | 100094912 | 4,9 x 12 | 6.0 – 8.0 | 50 |
| 30233 | 100094914 | 4,9 x 14 | 8.0 – 10.0 | 50 |
| 30234 | 100094916 | 4,9 x 16 | 10.0 – 12.0 | 50 |
| 30235 | 100094918 | 4,9 x 18 | 12.0 – 14.0 | 50 |
| 30236 | 100094921 | 4,9 x 21 | 14.0 – 16.0 | 50 |
| 30237 | 100094924 | 4,9 x 24 | 16.0 – 18.0 | 50 |
| 30238 | 100094930 | 4,9 x 30 | 21.0 – 25.0 | 50 |
| 30239 | 100094935 | 4,9 x 35 | 25.0 – 30.0 | 50 |

BLISTER GRANDE REMACHE LACADO

BLANCO

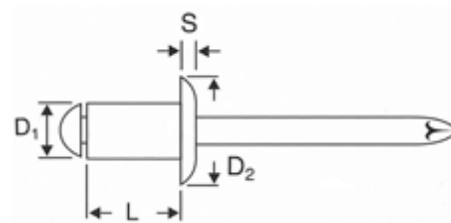

| CODIGO | REFERENCIA ∅ 3.2 mm. D2 = 6.5 mm. S = 1.0 mm. | 3.2 D1 x L | ESPEJOR A REMACHAR | CONTENIDO BLISTER |
|--------|--|---------------|-----------------------|----------------------|
| 72001 | 100193206 | 3,2 x 6 | 1.5 – 3.5 | 100 |
| 72003 | 100193208 | 3,2 x 8 | 3.5 – 5.5 | 100 |
| 72004 | 100193210 | 3,2 x 10 | 5.5 – 7.0 | 100 |
| 72005 | 100193212 | 3,2 x 12 | 7.0 – 9.0 | 100 |

| CODIGO | REFERENCIA ∅ 4 mm. D2 = 8.1 mm. S = 1.2 mm | 4 D1 x L | ESPEJOR A REMACHAR | CONTENIDO BLISTER |
|--------|---|-------------|-----------------------|----------------------|
| 72009 | 100193908 | 3,9 x 8 | 2.0 – 4.0 | 75 |
| 72010 | 100193910 | 3,9 x 10 | 4.0 – 6.0 | 75 |
| 72011 | 100193912 | 3,9 x 12 | 6.0 – 8.0 | 75 |
| 72012 | 100193915 | 3,9 x 15 | 8.0 – 10.0 | 75 |

| CODIGO | REFERENCIA ∅ 5 mm. D2 = 9.1 mm. S = 1.4 mm. | 5 D1 x L | ESPEJOR A REMACHAR | CONTENIDO BLISTER |
|--------|---|-------------|-----------------------|----------------------|
| 72029 | 100194910 | 4,9 x 10 | 4.0 – 6.0 | 50 |
| 72030 | 100194912 | 4,9 x 12 | 6.0 – 8.0 | 50 |
| 72032 | 100194915 | 4,9 x 15 | 8.0 – 10.0 | 50 |
| 72034 | 100194920 | 4,9 x 20 | 10.0 – 12.0 | 50 |

BLISTER GRANDE REMACHE LACADO

NEGRO

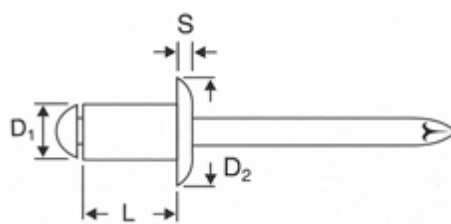

| CODIGO | REFERENCIA ∅ 3.2 mm. D2 = 6.5 mm. S = 1.0 mm. | 3.2 D1 x L | ESPEJOR A REMACHAR | CONTENIDO BLISTER |
|--------|--|---------------|-----------------------|----------------------|
| 72101 | 100293206 | 3,2 x 6 | 1.5 – 3.5 | 100 |
| 72103 | 100293208 | 3,2 x 8 | 3.5 – 5.5 | 100 |
| 72104 | 100293210 | 3,2 x 10 | 5.5 – 7.0 | 100 |
| 72105 | 100193212 | 3,2 x 12 | 7.0 – 9.0 | 100 |

| CODIGO | REFERENCIA ∅ 4 mm. D2 = 8.1 mm. S = 1.2 mm | 4 D1 x L | ESPEJOR A REMACHAR | CONTENIDO BLISTER |
|--------|---|-------------|-----------------------|----------------------|
| 72109 | 100293908 | 3,9 x 8 | 2.0 – 4.0 | 75 |
| 72110 | 100293910 | 3,9 x 10 | 4.0 – 6.0 | 75 |
| 72111 | 100293912 | 3,9 x 12 | 6.0 – 8.0 | 75 |
| 72112 | 100293915 | 3,9 x 15 | 8.0 – 10.0 | 75 |

| CODIGO | REFERENCIA ∅ 5 mm. D2 = 9.1 mm. S = 1.4 mm. | 5 D1 x L | ESPEJOR A REMACHAR | CONTENIDO BLISTER |
|--------|---|-------------|-----------------------|----------------------|
| 72129 | 100294910 | 4,9 x 10 | 4.0 – 6.0 | 50 |
| 72130 | 100294912 | 4,9 x 12 | 6.0 – 8.0 | 50 |
| 72132 | 100294915 | 4,9 x 15 | 8.0 – 10.0 | 50 |
| 72134 | 100294920 | 4,9 x 20 | 10.0 – 12.0 | 50 |

BLISTER GRANDE REMACHE CABEZA GRANDE

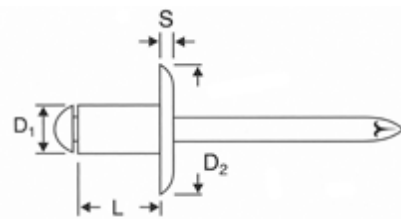

| CODIGO | REFERENCIA ∅ 4 mm. D2 = 10 mm. S = 1.2 mm. | 4 D1 x L | € / BLISTER | ESPEJOR A REMACHAR | CONTENIDO BLISTER |
|--------|---|-------------|-------------|-----------------------|----------------------|
| 32709 | 110093910 | 3,9 x 10 | 5,98 | 3.5 – 5.5 | 75 |
| 32710 | 110093912 | 3,9 x 12 | 5,98 | 5.5 – 7.0 | 75 |
| 32711 | 110093914 | 3,9 x 14 | 5,98 | 7.0 – 9.0 | 75 |
| 32712 | 110093916 | 3,9 x 16 | 5,98 | 9.0 – 12.0 | 75 |
| 32713 | 110093918 | 3,9 x 18 | 5,98 | 12.0 – 14.0 | 75 |
| 32714 | 110093920 | 3,9 x 20 | 5,98 | 14.0 – 16.0 | 75 |

| CODIGO | REFERENCIA ∅ 5 mm. D2 = 14 mm. S = 1.4 mm. | 5 D1 x L | € / BLISTER | ESPEJOR A REMACHAR | CONTENIDO BLISTER |
|--------|---|-------------|-------------|-----------------------|----------------------|
| 32728 | 110094910 | 4,9 x 10 | 5,98 | 4.0 – 6.0 | 50 |
| 32729 | 110094912 | 4,9 x 12 | 5,98 | 6.0 – 8.0 | 50 |
| 32730 | 110094914 | 4,9 x 14 | 5,98 | 8.0 – 10.0 | 50 |
| 32731 | 110094916 | 4,9 x 16 | 5,98 | 10.0 – 12.0 | 50 |
| 32732 | 110094918 | 4,9 x 18 | 5,98 | 12.0 – 14.0 | 50 |
| 32733 | 110094921 | 4,9 x 21 | 5,98 | 14.0 – 16.0 | 50 |
| 32734 | 110094924 | 4,9 x 24 | 5,98 | 16.0 – 18.0 | 50 |
| 32735 | 110094927 | 4,9 x 27 | 5,98 | 18.0 – 21.0 | 50 |
| 32736 | 110094930 | 4,9 x 30 | 5,98 | 21.0 – 25.0 | 50 |



BLISTER GRANDE REMACHE FLOR

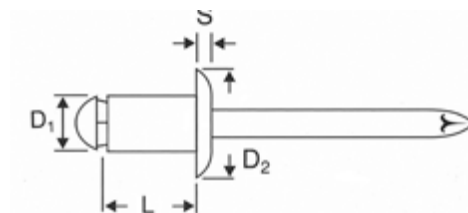

| CODIGO | REFERENCIA ∅ 5 mm. D2 = 14 mm. S = 1.4 mm. | 4 D1 x L | ESPEJOR A REMACHAR | CONTENIDO BLISTER |
|--------|---|-------------|-----------------------|----------------------|
| 39109 | 200093908 | 3,9 x 8 | 0.5 - 3.0 | 75 |
| 39110 | 200093910 | 3,9 x 10 | 3.0 - 5.0 | 75 |
| 39111 | 200093912 | 3,9 x 12 | 5.0 - 7.0 | 75 |
| 39115 | 200093915 | 3,9 x 15 | 9.0 - 10.0 | 75 |
| 39116 | 200093924 | 3,9 x 24 | 10.0 - 11.0 | 75 |
| 39117 | 200093927 | 3,9 x 27 | 11.0 - 13.0 | 75 |

| CODIGO | REFERENCIA ∅ 5 mm. D2 = 14 mm. S = 1.4 mm. | 5 D1 x L | ESPEJOR A REMACHAR | CONTENIDO BLISTER |
|--------|---|-------------|-----------------------|----------------------|
| 39128 | 200094908 | 4,9 x 8 | 0.5 - 3.0 | 50 |
| 39129 | 200094910 | 4,9 x 10 | 3.0 - 5.0 | 50 |
| 39130 | 200094912 | 4,9 x 12 | 5.0 - 7.0 | 50 |
| 39125 | 200094915 | 4,9 x 15 | 9.0 - 10.0 | 50 |
| 39132 | 200094916 | 4,9 x 16 | 10.0 - 11.0 | 50 |
| 39135 | 200094924 | 4,9 x 24 | 11.0 - 13.0 | 50 |

BLISTER GRANDE REMACHE ACERO

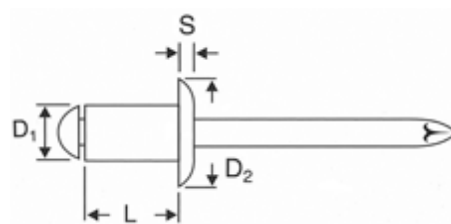

| CODIGO | REFERENCIA ∅ 3.2 mm. D2 = 6.5 mm. S = 1.0 mm. | 3.2 D1 x L | ESPEJOR A REMACHAR | CONTENIDO BLISTER |
|--------|--|---------------|-----------------------|----------------------|
| 35201 | 140093206 | 3,2 x 6 | 1.5 – 3.5 | 100 |
| 35202 | 140093208 | 3,2 x 8 | 3.5 – 5.5 | 100 |
| 35206 | 140093210 | 3,2 x 10 | 5.5 – 7.0 | 100 |
| 35207 | 140093210 | 3,2 x 12 | 7.0 – 9.0 | 100 |

| CODIGO | REFERENCIA ∅ 4 mm. D2 = 8.1 mm. S = 1.2 mm | 4 D1 x L | ESPEJOR A REMACHAR | CONTENIDO BLISTER |
|--------|---|-------------|-----------------------|----------------------|
| 35208 | 140093806 | 3,8 x 6 | 0.5 – 2.0 | 75 |
| 35209 | 140093808 | 3,8 x 8 | 2.0 – 4.0 | 75 |
| 35210 | 140093810 | 3,8 x 10 | 4.0 – 6.0 | 75 |
| 35211 | 140093812 | 3,8 x 12 | 6.0 – 8.0 | 75 |
| 35212 | 140093814 | 3,8 x 14 | 8.0 – 10.0 | 75 |
| 35219 | 140093816 | 3,8 x 16 | 10.0 – 12.0 | 75 |

| CODIGO | REFERENCIA ∅ 5 mm. D2 = 9.1 mm. S = 1.4 mm. | 5 D1 x L | ESPEJOR A REMACHAR | CONTENIDO BLISTER |
|--------|--|-------------|-----------------------|----------------------|
| 35229 | 140094810 | 4,8 x 10 | 4.0 – 6.0 | 50 |
| 35230 | 140094812 | 4,8 x 12 | 6.0 – 8.0 | 50 |
| 35231 | 140094814 | 4,8 x 14 | 8.0 – 10.0 | 50 |
| 35232 | 140094816 | 4,8 x 16 | 10.0 – 12.0 | 50 |

BLISTER GRANDE REMACHE INOX A/2

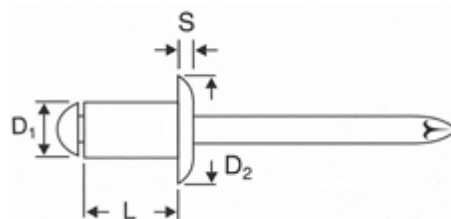

| CODIGO | REFERENCIA ∅ 3.2 mm. D2 = 6.5 mm. S = 1.1 mm. | 3.2 D1 x L | ESPEJOR A REMACHAR | CONTENIDO BLISTER |
|--------|--|---------------|-----------------------|----------------------|
| 37203 | 150093206 | 3,2 x 6 | 1.5 – 3.5 | 100 |
| 37204 | 150093208 | 3,2 x 8 | 3.5 – 5.5 | 100 |
| 37205 | 150093210 | 3,2 x 10 | 5.5 – 7.0 | 100 |

| CODIGO | REFERENCIA ∅ 4 mm. D2 = 8.1 mm. S = 1.2 mm. | 4 D1 x L | ESPEJOR A REMACHAR | CONTENIDO BLISTER |
|--------|--|-------------|-----------------------|----------------------|
| 37208 | 150093806 | 3,8 x 6 | 0.5 – 2.0 | 50 |
| 37209 | 150093808 | 3,8 x 8 | 2.0 – 4.0 | 50 |
| 37210 | 150093810 | 3,8 x 10 | 4.0 – 6.0 | 50 |
| 37211 | 150093812 | 3,8 x 12 | 6.0 – 8.0 | 50 |
| 37212 | 150093814 | 3,8 x 14 | 8.0 – 10.0 | 50 |
| 37214 | 150093816 | 3,8 x 16 | 10.0 – 12.0 | 50 |

| CODIGO | REFERENCIA ∅ 5 mm. D2 = 9.1 mm. S = 1.4 mm. | 5 D1 x L | ESPEJOR A REMACHAR | CONTENIDO BLISTER |
|--------|--|-------------|-----------------------|----------------------|
| 37228 | 150094808 | 4,8 x 8 | 2.0 – 4.0 | 50 |
| 37229 | 150094810 | 4,8 x 10 | 4.0 – 6.0 | 50 |
| 37230 | 150094812 | 4,8 x 12 | 6.0 – 8.0 | 50 |
| 37231 | 150094814 | 4,8 x 14 | 8.0 – 10.0 | 50 |
| 37232 | 150094816 | 4,8 x 16 | 10.0 – 12.0 | 50 |

BLISTER GRANDE TUERCA REMACHABLE ACERO CON CABEZA

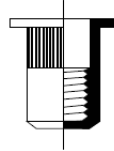
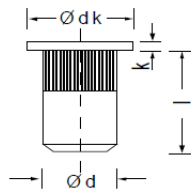

| CODIGO | REFERENCIA | METRICA mm | l mm (+0.5/-0) | ESPEJOR | CONTENIDO |
|--------|------------|------------|----------------|-----------|-----------|
| 99503 | 76100093 | M3 (5.0) | 10.5 | 0.5 – 2.5 | 80 |
| 99504 | 76100094 | M4 (6.0) | 11.0 | 0.5 – 3.0 | 70 |
| 99505 | 76100095 | M5 (7.0) | 13.0 | 0.5 – 3.0 | 60 |
| 99506 | 76100096 | M6 (9.0) | 16.0 | 0.5 – 3.0 | 50 |
| 99508 | 76100098 | M8 (11.0) | 17.5 | 0.5 – 3.0 | 50 |
| 99510 | 761000910 | M10 (12.0) | 19.0 | 0.5 – 3.0 | 40 |
| 99512 | 761000912 | M12 (16.0) | 25.0 | 1.0 – 4.0 | 40 |

BLISTER GRANDE TUERCA REMACHABLE ACERO SIN CABEZA

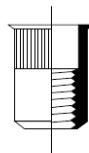
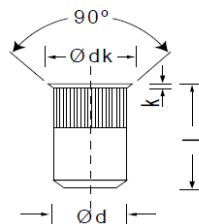

| CODIGO | REFERENCIA | METRICA mm | l mm (+0.5/-0) | ESPEJOR | CONTENIDO |
|--------|------------|------------|----------------|-----------|-----------|
| 95503 | 76103093 | M3 (5.0) | 9.5 | 0.5 – 2.5 | 80 |
| 95504 | 76103094 | M4 (6.0) | 10.0 | 0.5 – 3.0 | 80 |
| 95505 | 76103095 | M5 (7.0) | 11.5 | 0.5 – 3.0 | 70 |
| 95506 | 76103096 | M6 (9.0) | 14.0 | 0.5 – 3.0 | 60 |
| 95508 | 76103098 | M8 (11.0) | 15.5 | 0.5 – 3.0 | 50 |
| 95010 | 761030910 | M10 (12.0) | 19.5 | 0.8 – 3.5 | 40 |

BLISTER GRANDE TUERCA REMACHABLE INOX CON CABEZA

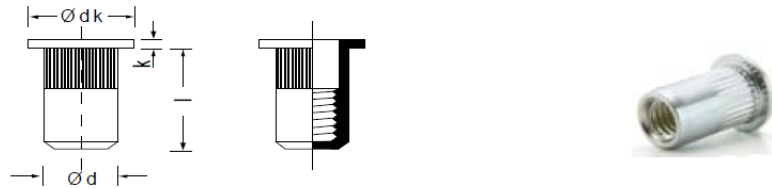

| CODIGO | REFERENCIA | METRICA mm | l mm (+0.5/-0) | ESPEJOR | CONTENIDO |
|--------|------------|---------------|-------------------|-----------|-----------|
| 99604 | 76200094 | M4 (6.0) | 11.0 | 0.5 – 3.0 | 80 |
| 99605 | 76200095 | M5 (7.0) | 13.0 | 0.5 – 3.0 | 70 |
| 99606 | 76200096 | M6 (9.0) | 16.0 | 0.5 – 3.0 | 60 |
| 99608 | 76200098 | M8 (11.0) | 17.5 | 0.5 – 3.0 | 50 |
| 99610 | 762000910 | M10 (13.0) | 19.0 | 0.5 – 3.0 | 50 |

BLISTER GRANDE TUERCA REMACHABLE INOX SIN CABEZA

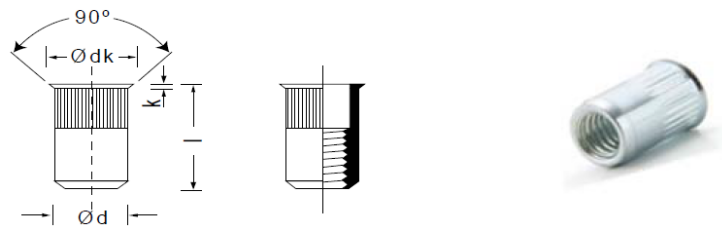

| CODIGO | REFERENCIA | METRICA mm | l mm (+0.5/-0) | ESPEJOR | CONTENIDO |
|--------|------------|---------------|-------------------|-----------|-----------|
| 95604 | 76203094 | M4 (6.0) | 10.0 | 0.5 – 2.5 | 80 |
| 95605 | 76203095 | M5 (7.0) | 11.5 | 0.5 – 3.0 | 80 |
| 95606 | 76203096 | M6 (9.0) | 14.0 | 0.5 – 3.0 | 70 |
| 95608 | 76203098 | M8 (11.0) | 15.5 | 0.5 – 3.0 | 60 |
| 95610 | 762030910 | M10 (13.0) | 19.5 | 0.8 – 3.5 | 50 |

BLISTER GRANDE TUERCA REMACHABLE ALUMINIO CON CABEZA

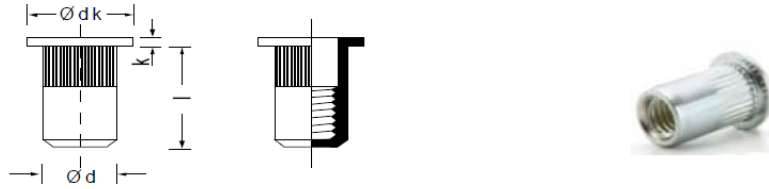

| CODIGO | REFERENCIA | METRICA mm | l mm (+0.5/-0) | ESPESOR | CONTENIDO |
|--------|------------|------------|----------------|-----------|-----------|
| 99903 | 76400093 | M3 (5.0) | 10.5 | 0.5 – 2.5 | 80 |
| 99904 | 76400094 | M4 (6.0) | 11.0 | 0.5 – 3.0 | 70 |
| 99905 | 76400095 | M5 (7.0) | 13.0 | 0.5 -3.0 | 60 |
| 99906 | 76400096 | M6 (9.0) | 16.0 | 0.5 -3.0 | 50 |
| 99908 | 76400098 | M8 (11.0) | 17.5 | 0.5 – 3.0 | 50 |
| 99910 | 764000910 | M10 (12.0) | 19.0 | 0.5 – 3.0 | 40 |
| 99912 | 764000912 | M12 (16.0) | 25.0 | 1.0 – 4.0 | 40 |

BLISTER GRANDE TUERCA REMACHABLE ALUMINIO SIN CABEZA

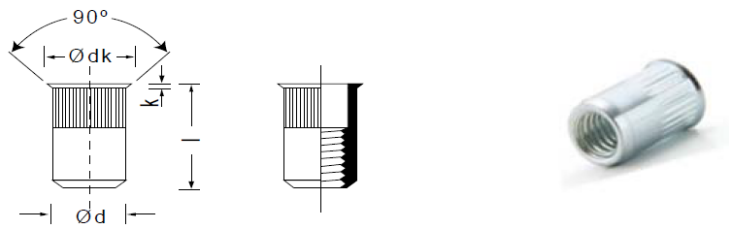

| CODIGO | REFERENCIA | METRICA mm | l mm (+0.5/-0) | ESPESOR | CONTENIDO |
|--------|------------|------------|----------------|-----------|-----------|
| 95903 | 76403093 | M3 (5.0) | 9.5 | 0.5 – 2.5 | 80 |
| 95904 | 76403094 | M4 (6.0) | 10.0 | 0.5 – 3.0 | 80 |
| 95905 | 76403095 | M5 (7.0) | 11.5 | 0.5 – 3.0 | 70 |
| 95906 | 76403096 | M6 (9.0) | 14.0 | 0.5 – 3.0 | 60 |
| 95908 | 76403098 | M8 (11.0) | 15.5 | 0.5 – 3.0 | 50 |

BLISTER PEQUEÑO REMACHE ESTANDAR

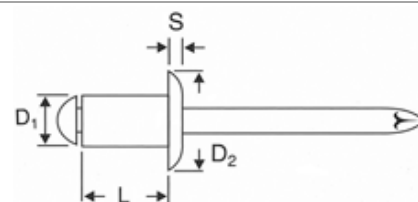

| CODIGO | REFERENCIA ∅ 3.2 mm. D2 = 6.5 mm. S = 1.0 mm. | 3.2 D1 x L | ESPEJOR A REMACHAR | CONTENIDO BLISTER |
|--------|--|---------------|-----------------------|----------------------|
| 30103 | 100083206 | 3,2 x 6 | 1.5 – 3.5 | 40 |
| 30104 | 100083208 | 3,2 x 8 | 3.5 – 5.5 | 40 |
| 30105 | 100083210 | 3,2 x 10 | 5.5 – 7.0 | 40 |
| 30106 | 100083212 | 3,2 x 12 | 7.0 – 9.0 | 40 |
| 30107 | 100083215 | 3,2 x 15 | 9.0 – 12.0 | 40 |
| 30108 | 100083218 | 3,2 x 18 | 12.0 – 15.0 | 40 |

| CODIGO | REFERENCIA ∅ 4 mm. D2 = 8.1 mm. S = 1.2 mm. | 4 D1 x L | ESPEJOR A REMACHAR | CONTENIDO BLISTER |
|--------|--|-------------|-----------------------|----------------------|
| 30109 | 100083906 | 3,9 x 6 | 0.5 – 2.0 | 30 |
| 30110 | 100083908 | 3,9 x 8 | 2.0 – 4.0 | 30 |
| 30111 | 100083910 | 3,9 x 10 | 4.0 – 6.0 | 30 |
| 30112 | 100083912 | 3,9 x 12 | 6.0 – 8.0 | 30 |
| 30113 | 100083914 | 3,9 x 14 | 8.0 – 10.0 | 30 |
| 30114 | 100083916 | 3,9 x 16 | 10.0 – 12.0 | 30 |
| 30115 | 100083918 | 3,9 x 18 | 12.0 – 14.0 | 30 |
| 30116 | 100083920 | 3,9 x 20 | 14.0 – 16.0 | 30 |

| CODIGO | REFERENCIA ∅ 5 mm. D2 = 9.1 mm. S = 1.4 mm. | 5 D1 x L | ESPEJOR A REMACHAR | CONTENIDO BLISTER |
|--------|--|-------------|-----------------------|----------------------|
| 30128 | 100084906 | 4,9 x 6 | 0.5 – 2.0 | 20 |
| 30129 | 100084908 | 4,9 x 8 | 2.0 – 3.5 | 20 |
| 30130 | 100084910 | 4,9 x 10 | 4.0 – 6.0 | 20 |
| 30131 | 100084912 | 4,9 x 12 | 6.0 – 8.0 | 20 |
| 30132 | 100084914 | 4,9 x 14 | 8.0 – 10.0 | 20 |
| 30133 | 100084916 | 4,9 x 16 | 10.0 – 12.0 | 20 |
| 30134 | 100084918 | 4,9 x 18 | 12.0 – 14.0 | 20 |
| 30135 | 100084921 | 4,9 x 21 | 14.0 – 16.0 | 15 |
| 30136 | 100084924 | 4,9 x 24 | 16.0 – 18.0 | 15 |
| 30107 | 100084930 | 4,9 x 30 | 21.0 – 25.0 | 15 |
| 30108 | 100084935 | 4,9 x 35 | 25.0 – 30.0 | 15 |

BLISTER PEQUEÑO REMACHE ALUMINIO LACADO

BLANCO

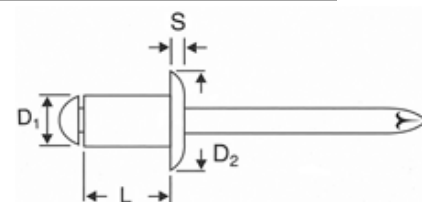

| CODIGO | REFERENCIA ∅ 3.2 mm. D2 = 6.5 mm. S = 1.0 mm. | 3.2 D1 x L | ESPEJOR A REMACHAR | CONTENIDO BLISTER |
|--------|--|---------------|-----------------------|----------------------|
| 71001 | 100183206 | 3,2 x 6 | 1.5 – 3.5 | 40 |
| 71003 | 100183208 | 3,2 x 8 | 3.5 – 5.5 | 40 |
| 71004 | 100183210 | 3,2 x 10 | 5.5 – 7.0 | 40 |
| 71005 | 100183212 | 3,2 x 12 | 7.0 – 9.0 | 40 |

| CODIGO | REFERENCIA ∅ 4 mm. D2 = 8.1 mm. S = 1.2 mm. | 4 D1 x L | ESPEJOR A REMACHAR | CONTENIDO BLISTER |
|--------|--|-------------|-----------------------|----------------------|
| 71009 | 100183908 | 3,9 x 8 | 2.0 – 4.0 | 30 |
| 71010 | 100183910 | 3,9 x 10 | 4.0 – 6.0 | 30 |
| 71011 | 100183912 | 3,9 x 12 | 6.0 – 8.0 | 30 |
| 71012 | 100183914 | 3,9 x 14 | 8.0 – 10.0 | 30 |

| CODIGO | REFERENCIA ∅ 5 mm. D2 = 9.1 mm. S = 1.4 mm. | 5 D1 x L | ESPEJOR A REMACHAR | CONTENIDO BLISTER |
|--------|--|-------------|-----------------------|----------------------|
| 71029 | 100184910 | 4,9 x 10 | 4.0 – 6.0 | 20 |
| 71030 | 100184912 | 4,9 x 12 | 6.0 – 8.0 | 20 |
| 71032 | 100184915 | 4,9 x 15 | 8.0 – 10.0 | 20 |
| 71034 | 100184915 | 4,9 x 20 | 10.0 – 12.0 | 15 |

BLISTER PEQUEÑO REMACHE ALUMINIO LACADO

NEGRO

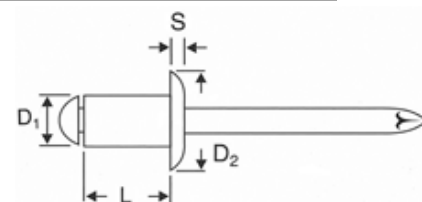

| CODIGO | REFERENCIA ∅ 3.2 mm. D2 = 6.5 mm. S = 1.0 mm. | 3.2 D1 x L | ESPEJOR A REMACHAR | CONTENIDO BLISTER |
|--------|--|---------------|-----------------------|----------------------|
| 71101 | 100283206 | 3,2 x 6 | 1.5 – 3.5 | 40 |
| 71103 | 100283208 | 3,2 x 8 | 3.5 – 5.5 | 40 |
| 71104 | 100283210 | 3,2 x 10 | 5.5 – 7.0 | 40 |
| 71105 | 100283212 | 3,2 x 12 | 7.0 – 9.0 | 40 |

| CODIGO | REFERENCIA ∅ 4 mm. D2 = 8.1 mm. S = 1.2 mm. | 4 D1 x L | ESPEJOR A REMACHAR | CONTENIDO BLISTER |
|--------|--|-------------|-----------------------|----------------------|
| 71109 | 100283908 | 3,9 x 8 | 2.0 – 4.0 | 30 |
| 71110 | 100283910 | 3,9 x 10 | 4.0 – 6.0 | 30 |
| 71111 | 100283912 | 3,9 x 12 | 6.0 – 8.0 | 30 |
| 71112 | 100283914 | 3,9 x 14 | 8.0 – 10.0 | 30 |

| CODIGO | REFERENCIA ∅ 5 mm. D2 = 9.1 mm. S = 1.4 mm. | 5 D1 x L | ESPEJOR A REMACHAR | CONTENIDO BLISTER |
|--------|--|-------------|-----------------------|----------------------|
| 71129 | 100284910 | 4,9 x 10 | 4.0 – 6.0 | 20 |
| 71130 | 100284912 | 4,9 x 12 | 6.0 – 8.0 | 20 |
| 71132 | 100284915 | 4,9 x 15 | 8.0 – 10.0 | 20 |
| 71134 | 100284915 | 4,9 x 20 | 10.0 – 12.0 | 15 |

BLISTER PEQUEÑO REMACHE CABEZA GRANDE

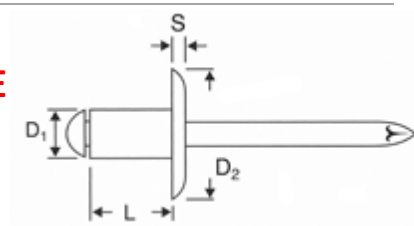

| CODIGO | REFERENCIA ∅ 4 mm. D2 = 10 mm. S = 1.2 mm. | 4 D1 x L | ESPEJOR A REMACHAR | CONTENIDO BLISTER |
|---------------|--|--------------------|-------------------------------------|------------------------------------|
| 30709 | 110083910 | 3,9 x 10 | 3.5 – 5.5 | 40 |
| 30710 | 110083912 | 3,9 x 12 | 5.5 – 7.0 | 40 |
| 30711 | 110083914 | 3,9 x 14 | 7.0 – 9.0 | 40 |
| 30712 | 110083916 | 3,9 x 16 | 9.0 – 12.0 | 40 |
| 30713 | 110083918 | 3,9 x 18 | 12.0 – 14.0 | 40 |
| 30714 | 110083920 | 3,9 x 20 | 14.0 – 16.0 | 40 |

| CODIGO | REFERENCIA ∅ 5 mm. D2 = 14 mm. S = 1.4 mm. | 5 D1 x L | ESPEJOR A REMACHAR | CONTENIDO BLISTER |
|---------------|--|--------------------|-------------------------------------|------------------------------------|
| 30728 | 110084910 | 4,9 x 10 | 4.0 – 6.0 | 15 |
| 30729 | 110084912 | 4,9 x 12 | 6.0 – 8.0 | 15 |
| 30730 | 110084914 | 4,9 x 14 | 8.0 – 10.0 | 15 |
| 30731 | 110084916 | 4,9 x 16 | 10.0 – 12.0 | 15 |
| 30732 | 110084918 | 4,9 x 18 | 12.0 – 14.0 | 15 |
| 30733 | 110084921 | 4,9 x 21 | 14.0 – 16.0 | 15 |
| 30734 | 110084924 | 4,9 x 24 | 16.0 – 18.0 | 15 |
| 30735 | 110084927 | 4,9 x 27 | 18.0 – 21.0 | 15 |
| 30736 | 110084930 | 4,9 x 30 | 21.0 – 25.0 | 15 |

BLISTER PEQUEÑO REMACHE FLOR

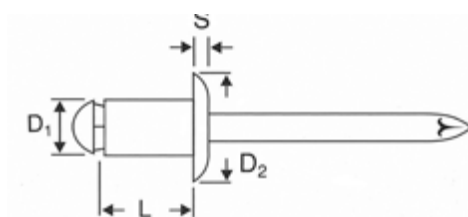

| CODIGO | REFERENCIA ∅ 5 mm. D2 = 14 mm. S = 1.4 mm | 4 D1 x L | ESPEJOR A REMACHAR | CONTENIDO BLISTER |
|--------|--|-------------|-----------------------|----------------------|
| 39009 | 200083908 | 3,9 x 8 | 0.5 - 3.0 | 30 |
| 39010 | 200083910 | 3,9 x 10 | 3.0 - 5.0 | 30 |
| 39011 | 200083912 | 3,9 x 12 | 5.0 - 7.0 | 30 |
| 39015 | 200083915 | 3,9 x 15 | 9.0 - 10.0 | 30 |
| 39016 | 200083924 | 3,9 x 24 | 10.0 -11.0 | 30 |
| 39017 | 200083927 | 3,9 x 27 | 11.0 -13.0 | 30 |

| CODIGO | REFERENCIA ∅ 5 mm. D2 = 14 mm. S = 1.4 mm. | 5 D1 x L | ESPEJOR A REMACHAR | CONTENIDO BLISTER |
|--------|---|-------------|-----------------------|----------------------|
| 39028 | 200084908 | 4,9 x 8 | 0.5 - 3.0 | 20 |
| 39029 | 200084910 | 4,9 x 10 | 3.0 - 5.0 | 20 |
| 39030 | 200084912 | 4,9 x 12 | 5.0 - 7.0 | 20 |
| 39025 | 200084915 | 4,9 x 15 | 9.0 - 10.0 | 15 |
| 39032 | 200084916 | 4,9 x 16 | 10.0 -11.0 | 15 |
| 39035 | 200084924 | 4,9 x 24 | 11.0 -13.0 | 15 |
| 39038 | 200084935 | 4,9 x 35 | 25.0 - 30.0 | 15 |

BLISTER PEQUEÑO REMACHE ACERO

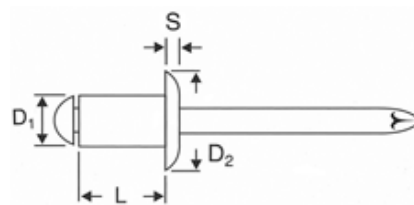

| CODGIGO | REFERENCIA ∅ 3.2 mm. D2 = 6.5 mm. S = 1.0 mm. | 3.2 D1 x L | ESPEJOR A REMACHAR | CONTENIDO BLISTER |
|---------|--|---------------|-----------------------|----------------------|
| 35101 | 140083206 | 3,2 x 6 | 1.5 – 3.5 | 40 |
| 35102 | 140083208 | 3,2 x 8 | 3.5 – 5.5 | 40 |
| 35106 | 140083210 | 3,2 x 10 | 5.5 – 7.0 | 40 |
| 35107 | 140083212 | 3,2 x 12 | 7.0 – 9.0 | 40 |

| CODIGO | REFERENCIA ∅ 4 mm. D2 = 8.1 mm. S = 1.2 mm. | 4 D1 x L | ESPEJOR A REMACHAR | CONTENIDO BLISTER |
|--------|--|-------------|-----------------------|----------------------|
| 35108 | 140083806 | 3,8 x 6 | 0.5 – 2.0 | 30 |
| 35109 | 140083808 | 3,8 x 8 | 2.0 – 4.0 | 30 |
| 35110 | 140083810 | 3,8 x 10 | 4.0 – 6.0 | 30 |
| 35111 | 140083812 | 3,8 x 12 | 6.0 – 8.0 | 30 |
| 35112 | 140083814 | 3,8 x 14 | 8.0 – 10.0 | 30 |
| 35119 | 140083816 | 3,8 x 16 | 10.0 – 12.0 | 30 |

| CODIGO | REFERENCIA ∅ 5 mm. D2 = 9.1 mm. S = 1.4 mm. | 5 D1 x L | ESPEJOR A REMACHAR | CONTENIDO BLISTER |
|--------|--|-------------|-----------------------|----------------------|
| 35129 | 140084810 | 4,8 x 10 | 4.0 – 6.0 | 20 |
| 35130 | 140084812 | 4,8 x 12 | 6.0 – 8.0 | 20 |
| 35131 | 140084814 | 4,8 x 14 | 8.0 – 10.0 | 15 |
| 35132 | 140084816 | 4,8 x 16 | 10.0 – 12.0 | 15 |

BLISTER PEQUEÑO REMACHE INOX A/2

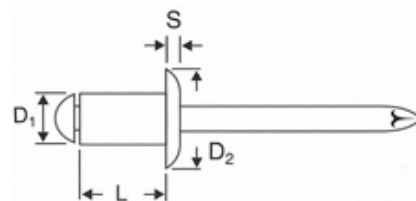

| CODIGO | REFERENCIA ∅ 3.2 mm. D2 = 6.5 mm. S = 1.1 mm. | 3.2 D1 x L | ESPEJOR A REMACHAR | CONTENIDO BLISTER |
|--------|--|---------------|-----------------------|----------------------|
| 37003 | 150083206 | 3,2 x 6 | 1.5 – 3.5 | 40 |
| 37004 | 150083208 | 3,2 x 8 | 3.5 – 5.5 | 40 |
| 37005 | 150083210 | 3,2 x 10 | 5.5 – 7.0 | 40 |

| CODIGO | REFERENCIA ∅ 4 mm. D2 = 8.1 mm. S = 1.2 mm. | 4 D1 x L | ESPEJOR A REMACHAR | CONTENIDO BLISTER |
|--------|--|-------------|-----------------------|----------------------|
| 37008 | 150083806 | 3,8 x 6 | 0.5 – 2.0 | 30 |
| 37009 | 150083808 | 3,8 x 8 | 2.0 – 4.0 | 30 |
| 37010 | 150083810 | 3,8 x 10 | 4.0 – 6.0 | 30 |
| 37011 | 150083812 | 3,8 x 12 | 6.0 – 8.0 | 30 |
| 37012 | 150083814 | 3,8 x 14 | 8.0 – 10.0 | 30 |
| 37014 | 150083816 | 3,8 x 16 | 10.0 – 12.0 | 30 |

| CODIGO | REFERENCIA ∅ 5 mm. D2 = 9.1 mm. S = 1.4 mm. | 5 D1 x L | ESPEJOR A REMACHAR | CONTENIDO BLISTER |
|--------|--|-------------|-----------------------|----------------------|
| 37028 | 150084808 | 4,8 x 8 | 2.0 – 4.0 | 20 |
| 37029 | 150084810 | 4,8 x 10 | 4.0 – 6.0 | 20 |
| 37030 | 150084812 | 4,8 x 12 | 6.0 – 8.0 | 15 |
| 37031 | 150084814 | 4,8 x 14 | 8.0 – 10.0 | 15 |
| 37032 | 150084816 | 4,8 x 16 | 10.0 – 12.0 | 15 |

BLISTER PEQUEÑO TUERCA REMACHABLE ACERO CON CABEZA

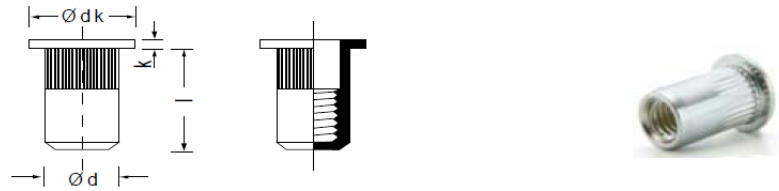

| CODIGO | REFERENCIA | METRICA mm | l mm (+0.5/-0) | ESPESOR | CONTENIDO |
|--------|------------|---------------|-------------------|-----------|-----------|
| 37503 | 76100083 | M3 (5.0) | 10.5 | 0.5 – 2.5 | 10 |
| 37504 | 76100084 | M4 (6.0) | 11.0 | 0.5 – 3.0 | 10 |
| 37505 | 76100085 | M5 (7.0) | 13.0 | 0.5 – 3.0 | 10 |
| 37506 | 76100086 | M6 (9.0) | 16.0 | 0.5 – 3.0 | 10 |
| 37508 | 76100088 | M8 (11.0) | 17.5 | 0.5 – 3.0 | 10 |
| 37510 | 761000810 | M10 (12.0) | 19.0 | 0.5 – 3.0 | 10 |
| 37512 | 761000812 | M12 (16.0) | 25.0 | 1.0 – 4.0 | 10 |

BLISTER PEQUEÑO TUERCA REMACHABLE ACERO SIN CABEZA

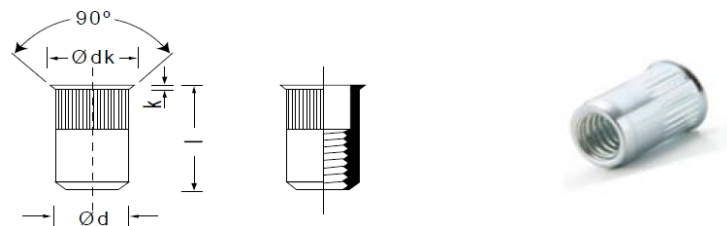

| CODIGO | REFERENCIA | METRICA mm | l mm (+0.5/-0) | ESPESOR | CONTENIDO |
|--------|------------|---------------|-------------------|-----------|-----------|
| 35503 | 76103083 | M3 (5.0) | 9.5 | 0.5 – 2.5 | 10 |
| 35504 | 76103084 | M4 (6.0) | 10.0 | 0.5 – 3.0 | 10 |
| 35505 | 76103085 | M5 (7.0) | 11.5 | 0.5 – 3.0 | 10 |
| 35506 | 76103086 | M6 (9.0) | 14.0 | 0.5 – 3.0 | 10 |
| 35508 | 76103088 | M8 (11.0) | 15.5 | 0.5 – 3.0 | 10 |
| 35510 | 761030810 | M10 (12.0) | 19.5 | 0.8 – 3.5 | 10 |

BLISTER PEQUEÑO TUERCA REMACHABLE INOX CON CABEZA

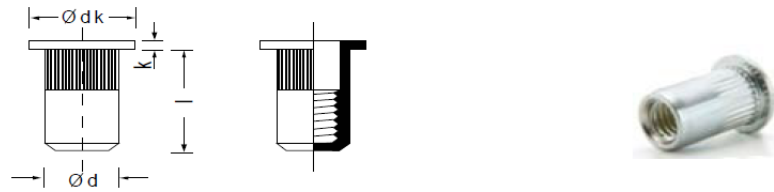

| CODIGO | REFERENCIA | METRICA mm | l mm (+0.5/-0) | ESPELOR | CONTENIDO |
|--------|------------|------------|----------------|-----------|-----------|
| 37604 | 76200084 | M4 (6.0) | 11.0 | 0.5 – 3.0 | 10 |
| 37605 | 76200085 | M5 (7.0) | 13.0 | 0.5 – 3.0 | 10 |
| 37606 | 76200086 | M6 (9.0) | 16.0 | 0.5 – 3.0 | 10 |
| 37608 | 76200088 | M8 (11.0) | 17.5 | 0.5 – 3.0 | 10 |
| 37610 | 762000810 | M10 (13.0) | 19.0 | 0.5 – 3.0 | 10 |

BLISTER PEQUEÑO TUERCA REMACHABLE INOX SIN CABEZA

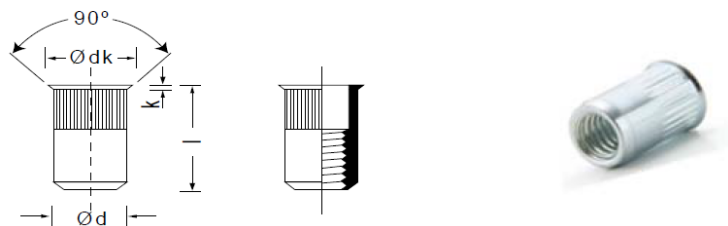

| CODIGO | REFERENCIA | METRICA mm | l mm (+0.5/-0) | ESPELOR | CONTENIDO |
|--------|------------|------------|----------------|-----------|-----------|
| 35604 | 76203084 | M4 (6.0) | 10.0 | 0.5 – 2.5 | 10 |
| 35605 | 76203085 | M5 (7.0) | 11.5 | 0.5 – 3.0 | 10 |
| 35606 | 76203086 | M6 (9.0) | 14.0 | 0.5 – 3.0 | 10 |
| 35608 | 76203088 | M8 (11.0) | 15.5 | 0.5 – 3.0 | 10 |
| 35610 | 762030810 | M10 (13.0) | 19.5 | 0.8 – 3.5 | 10 |

BLISTER PEQUEÑO TUERCA REMACHABLE ALUMINIO CON CABEZA

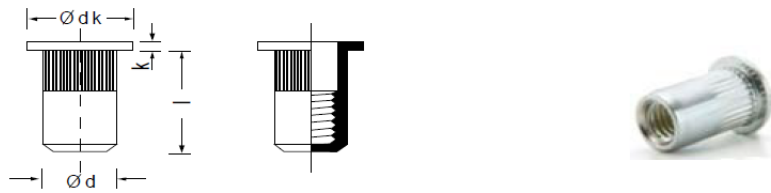

| CODIGO | REFERENCIA | METRICA mm | l mm (+0.5/-0) | ESPESOR | CONTENIDO |
|--------|------------|------------|----------------|-----------|-----------|
| 37903 | 76400083 | M3 (5.0) | 10.5 | 0.5 - 2.5 | 10 |
| 37904 | 76400084 | M4 (6.0) | 11.0 | 0.5 - 3.0 | 10 |
| 37905 | 76400085 | M5 (7.0) | 13.0 | 0.5 - 3.0 | 10 |
| 37906 | 76400086 | M6 (9.0) | 16.0 | 0.5 - 3.0 | 10 |
| 37908 | 76400088 | M8 (11.0) | 17.5 | 0.5 - 3.0 | 10 |
| 37910 | 764000810 | M10 (12.0) | 19.0 | 0.5 - 3.0 | 10 |
| 37912 | 764000812 | M12 (16.0) | 25.0 | 1.0 - 4.0 | 10 |

BLISTER PEQUEÑO TUERCA REMACHABLE ALUMINIO SIN CABEZA

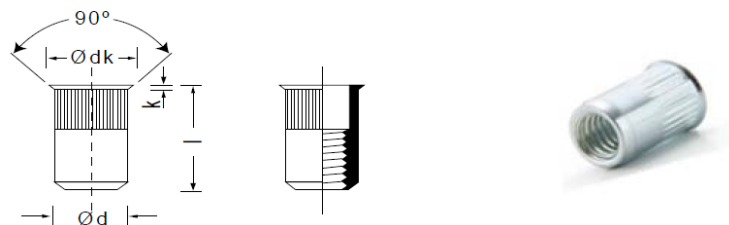

| CODIGO | REFERENCIA | METRICA mm | l mm (+0.5/-0) | ESPESOR | CONTENIDO |
|--------|------------|------------|----------------|-----------|-----------|
| 35903 | 76403083 | M3 (5.0) | 9.5 | 0.5 - 2.5 | 10 |
| 35904 | 76403084 | M4 (6.0) | 10.0 | 0.5 - 3.0 | 10 |
| 35905 | 76403085 | M5 (7.0) | 11.5 | 0.5 - 3.0 | 10 |
| 35906 | 76403086 | M6 (9.0) | 14.0 | 0.5 - 3.0 | 10 |
| 35908 | 76403088 | M8 (11.0) | 15.5 | 0.5 - 3.0 | 10 |



- 1 JUEGO REM. STANDARD +**
- 1 REMACHADORA B-3**
- 2 BLISTER DE 3 x 6 REM STANDARD (50 p)**
- 2 BLISTER DE 3 x 10 REM STANDARD (50p)**
- 2 BLISTER DE 4 x 8 REM STANDARD (40 p)**
- 2 BLISTER DE 4 x 10 REM STANDARD (40 p)**
- 2 BLISTER DE 4 x 12 REM STANDARD (40 p)**

REFERENCIA:JBR001
CODIGO:01263



- 1 JUEGO REM. STANDARD + REMACHADORA**
- 1 REMACHADORA C-4**
- 2 BLISTER DE 3 x 6 REM STANDARD (50 p)**
- 2 BLISTER DE 3 x 10 REM STANDARD (50p)**
- 2 BLISTER DE 4 x 8 REM STANDARD (40 p)**
- 2 BLISTER DE 4 x 10 REM STANDARD (40 p)**
- 2 BLISTER DE 4 x 12 REM STANDARD (40 p)**
- 2 BLISTER DE 5 x 10 REM STANDARD (30 p)**

CODIGO: JC4001
CODIGO: 01264



- 1 JUEGO REM. STANDARD + REMACHADORA**
- 1 REMACHADORA R-6**
- 2 BLISTER DE 3.2 x 6 REM STANDARD (50 p)**
- 2 BLISTER DE 3.2 x 10 REM STANDARD (50p)**
- 2 BLISTER DE 4 x 8 REM STANDARD (40 p)**
- 2 BLISTER DE 4 x 12 REM STANDARD (40 p)**
- 2 BLISTER DE 5 x 10 REM STANDARD (30 p)**
- 2 BLISTER DE 5 x 15 REM STANDARD (30 p)**

REFERENCIA:JR6001
CODIGO 01265



- 1 JUEGO T/REMACHABLE + REMACHADORA**
- 1 REMACHADORA DE TUERCAS**
- 2 BLISTER T/REMACHABLE AC. M5 CON CABEZA (40 p)**
- 2 BLISTER T/REMACHABLE AC. M6 CON CABEZA(30 p)**
- 2 BLISTER T/REMACHABLE AC. M8 CON CABEZA (20 p)**

REFERENCIA:JR6101
CODIGO 01266



1 CAJON CON 66 BLISTER

- CAJON DE REMACHES STANDARD**
- 6 BLISTER DE 3.2 x 6 REM STANDARD (50 p)
 - 6 BLISTER DE 3.2 x 8 REM STANDARD (50 p)
 - 6 BLISTER DE 3.2 x 10 REM STANDARD (50p)
 - 6 BLISTER DE 4 x 6 REM STANDARD (40 p)
 - 6 BLISTER DE 4 x 8 REM STANDARD (40 p)
 - 6 BLISTER DE 4 x 10 REM STANDARD (40p)
 - 6 BLISTER DE 4 x 12 REM STANDARD (40 p)
 - 6 BLISTER DE 5 x 8 REM STANDARD (30 p)
 - 6 BLISTER DE 5 x 10 REM STANDARD (30 p)
 - 6 BLISTER DE 5 x 12 REM STANDARD (30p)
 - 6 BLISTER DE 5 x 15 REM STANDARD (30 p)

NOTA: CONSULTAR CAJONES DE BLISTER PARA REMACHES LACADOS, ALA ANCHA, ALA SUPER, FLOR, ACERO, INOX ...

REFERENCIA:J66B01

CODIGO: 01267



1 CAJON CON 66 BLISTER

- CAJON DE TUERCAS REMACHABLES**
- 11 BLISTER T/REMACHABLE AC. M3 CON CABEZA (50 p)
 - 11 BLISTER T/REMACHABLE AC. M4 CON CABEZA(50 p)
 - 11 BLISTER T/REMACHABLE AC. M5 CON CABEZA (40 p)
 - 11 BLISTER T/REMACHABLE AC. M6 CON CABEZA(30 p)
 - 11 BLISTER T/REMACHABLE AC. M8 CON CABEZA (20 p)
 - 11 BLISTER T/REMACHABLE AC. M10 CON CABEZA (15 p)

NOTA: CONSULTAR CAJONES DE BLISTER PARA TUERCAS REMACHABLES INOX, ALUM, SIN CABEZA, CABEZA AVELLANADA, CIEGAS, HEXAGONALES, SEMIHEXAGONALES...

REFERENCIA:J66BT1

CODIGO: 01268

REMACHES MACIZOS Y SEMITUBULARES

REMACHES MACIZOS

REMACHES SEMITUBULARES

REMACHES PARA CUBAS

FITAS

PASADORES PARA BISAGRAS

PIEZAS ESTAMPADAS (MUEBLES DE COCINA...)

FABRICACION DE PIEZAS ESPECIALES (PLANO / MUESTRA)

MATERIALES: ACERO/ALUMINIO/INOX/LATON/COBRE...

CONSULTAR PRECIO Y DISPONIBILIDAD (AMPLIA GAMA EN STOCK)

FABRICACION BAJO PEDIDO.



REMACHE MACIZO

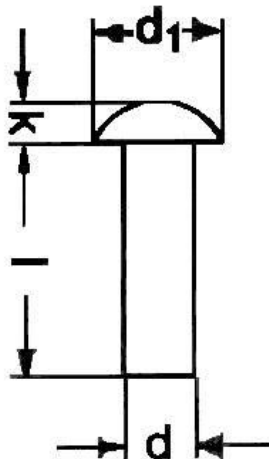

REMACHE MACIZO CABEZA REDONDA

(Diferentes materiales (acero, aluminio...), fabricación bajo plano o muestra, disponibilidad en STOCK de un surtido de medidas).

REMACHE MACIZO CABEZA AVELLANADO

(Diferentes materiales (acero, aluminio...)

, fabricación bajo plano o muestra, consulte disponibilidad).

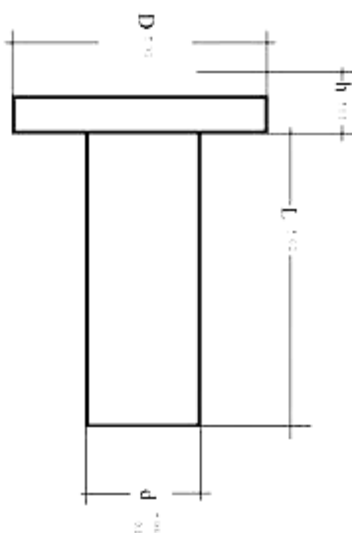
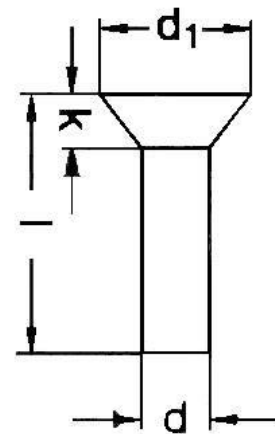

REMACHE MACIZO CABEZA PLANA

(Diferentes materiales (acero, aluminio...)

, fabricación bajo plano o muestra,

consulte disponibilidad).



REMACHES SEMITUBULARES

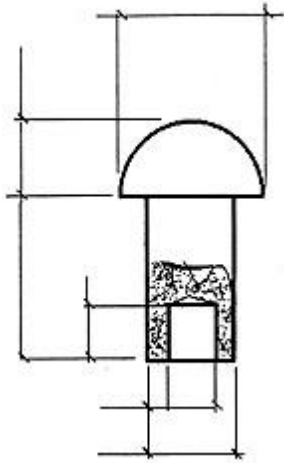

REMACHE SEMITUBULAR CABEZA REDONDA

(Diferentes materiales (aluminio, acero...), fabricación bajo plano o muestra, consulte disponibilidad)

REMACHE SEMITUBULAR CABEZA AVELLANADO

(Diferentes materiales (aluminio,acero...)

, fabricación bajo plano o muestra, consulte disponibilidad).

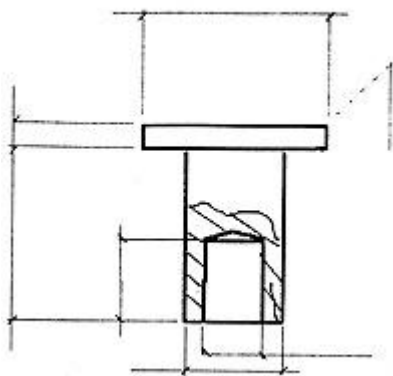
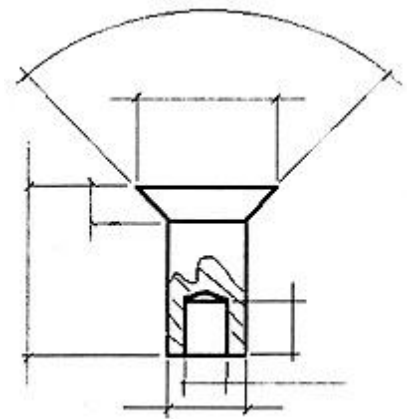

REMACHE SEMITUBULAR CABEZA PLANA

(Diferentes materiales (aluminio, acero...)

, fabricación bajo plano o muestra, consulte disponibilidad).



CABECEADORA NEUMATICA

REMACHES MACIZOS Y REMACHES SEMITUBULARES

REFERENCIA CNMS080

CODIGO 30028



INSERTO FINAL 8BUTEROLA): REDONDO Y HEXAGONAL

Nº DE GOLPES: 6500 /FUERZA: 1.2 J / CONSUMO DE AIRE: 5.6 L/SEC

DIAMETRO PISTON: 16 mm / CARRERA DEL EMBOLO: 45 mm

LONGITUD: 193 mm / PESO: 0.8 KGS / MANGUERA: 8mm

ROSCA DE CONESION: G ¼" i / VIBRACION: 3.3 m/s²

TIEMPO DE TRABAJO Max.: 18 H. / NIVEL DE RUIDO: 98dB (A)

APLICACIONES

REMACHE MACIZO DE ACERO HASTA Ø 5 mm (max.)

REMACHE SEMITUBULAR DE ACERO HASTA Ø 6 mm (max.)

REMACHE MACIZO DE ALUMINIO HASTA Ø 6 mm (max.)

REMACHE SEMITUBULAR DE ALUMINIO HASTA Ø 8 mm (max.)

REMACHE MACIZO COBRE HASTA Ø 5 mm (max.)

REMACHE SEMITUBULAR COBRE HASTA Ø 6 mm (max.)

REMACHE MACIZO LATON HASTA Ø 5 mm (max.)

REMACHE SEMITUBULAR LATON HASTA Ø 6 mm (max.)

LAS BUTEROLAS (INSERTOS) SE PREPARAN PARA REMACHAR MACIZOS Y SEMITUBULARES SEGÚN LOS DIAMETROS.

TUERCAS REMACHABLES

ACERO / ALUMINIO / INOX A2 / INOX A4



| DESCRIPCION | ACERO | ALUM. | INOX A2 | INOX A4 |
|---|-------|-------|---------|---------|
| TUERCA REMACHABLE CON CABEZA | X | X | X | X |
| TUERCA REMACHABLE CON CABEZA AVELLANADA | X | X | X | X |
| TUERCA REMACHABLE SIN CABEZA | X | X | X | |
| TUERCA REMACHABLE CON CABEZA CIEGA | X | X | | |
| TUERCA REMACHABLE CON CABEZA AVELLANADA CIEGA | X | | | |
| TUERCA REMACHABLE CON CABEZA HEXAGONAL | X | | | |
| TUERCA REMACHABLE SIN CABEZA HEXAGONAL | X | | | |
| TUERCA REMACHABLE SEMIHEXAGONAL CON CABEZA | X | | X | |
| TUERCA REMACHABLE SEMIHEXAGONAL SIN CABEZA | X | | X | |

TUERCA REMACHABLE ACERO CON CABEZA

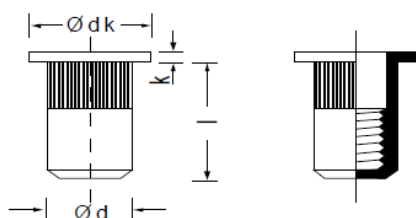

RIVET NUT FALT HEAD STEEL



| CODIGO | REFERENCIA | METRICA mm  | l mm (+0.5/ -0) | ESPESOR | dk mm (+0/- 0.5) | K ≤ mm | d mm (+0/- 0.2) |
|--------|------------|--|-----------------------|----------|---------------------------|--------------|--------------------------|
| 00844 | 76100031 | M3 (5.0) | 10,5 | 0,5-2,5 | 7,0 | 0,9 | 4,9 |
| 00845 | 76100032 | M3 (5,0) | 11,5 | 2,5-4,0 | 7,0 | 0,9 | 4,9 |
| 00846 | 76100041 | M4 (6,0) | 11,0 | 0,5-3,0 | 9,0 | 1,1 | 5,9 |
| 00847 | 76100042 | M4 (6,0) | 14,0 | 3,5-5,5 | 9,0 | 1,1 | 5,9 |
| 00848 | 76100051 | M5 (7,0) | 13,0 | 0,5-3,0 | 10,0 | 1,1 | 6,9 |
| 00849 | 76100052 | M5 (7,0) | 16,0 | 3,0-5,5 | 10,0 | 1,1 | 6,9 |
| 00850 | 76100053 | M5 (7,0) | 19,0 | 5,5-8,0 | 10,1 | 1,1 | 6,9 |
| 00851 | 76100061 | M6 (9.0) | 16.0 | 0,5-3,0 | 12.0 | 1.6 | 8.9 |
| 00852 | 76100062 | M6 (9.0) | 18.5 | 3,0-5,5 | 12.0 | 1.6 | 8.9 |
| 00853 | 76100063 | M6 (9.0) | 21.0 | 5,5-8,0 | 12.0 | 1.6 | 8.9 |
| 00854 | 76100081 | M8 (11.0) | 17.5 | 0.5-3.0 | 15.0 | 1.6 | 10.9 |
| 00855 | 76100082 | M8 (11.0) | 20.0 | 3.0-5.5 | 15.0 | 1.6 | 10.9 |
| 00856 | 76100083 | M8 (11.0) | 22.5 | 5.5-8.0 | 15.0 | 1.6 | 10.9 |
| 00857 | 76100084 | M8 (11.0) | 25.0 | 8.0-10.5 | 15.0 | 1.6 | 10.9 |
| 00858 | 761000101 | M10 (13.0) | 19.0 | 0.5-3.0 | 16.0 | 2.1 | 11.9 |
| 00859 | 761000102 | M10 (13.0) | 24.0 | 3.0-6.0 | 16.0 | 2.1 | 11.9 |
| 00934 | 761000103 | M10 (13.0) | 27.0 | 6.0-9.0 | 16.0 | 2.1 | 11.9 |
| 00935 | 761000104 | M10 (12.0) | 30.0 | 9.0-12.0 | 16.0 | 2.1 | 11.9 |
| 00936 | 761000121 | M12 (16.0) | 25.0 | 1.0-4.0 | 22.0 | 2.1 | 15.9 |
| 00937 | 761000122 | M12 (16.0) | 28.0 | 4.0-7.0 | 22.0 | 2.1 | 15.9 |
| 00938 | 761000123 | M12 (16.0) | 31.0 | 7.0-10.0 | 22.0 | 2.1 | 15.9 |

DATOS MECANICOS



| METRICA |  (Nm) |  |  |
|---------|---|---|---|
| M3 | 3,0 | 4.900 | 990 |
| M4 | 4,5 | 7.840 | 1.660 |
| M5 | 7,8 | 11.070 | 2.760 |
| M6 | 20,0 | 17.640 | 3.430 |
| M8 | 29,0 | 27.440 | 4.410 |
| M10 | 32,0 | 29.400 | 4.900 |
| M12 | 43,7 | 48.020 | 6.860 |

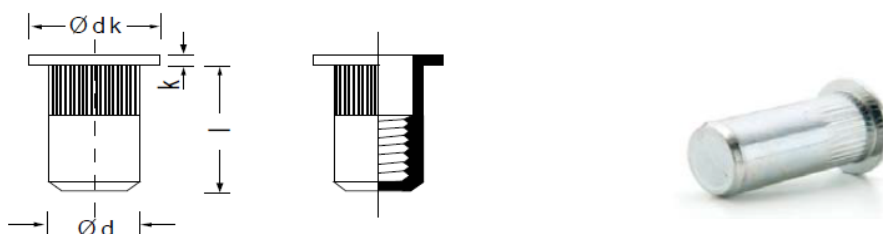

TUERCA REMACHABLE ACERO CON CABEZA CIEGAS- RIVET NUT FALT HEAD STEEL CLOSED END



| CODIGO | REFERENCIA | METRICA mm  | l mm (+0.5/ -0) | ESPESOR | D2 mm (+0/- 0.5) | K ≤ mm | D1 mm (+0/- 0.2) |
|--------|------------|--|-----------------------|----------|---------------------------|--------------|---------------------------|
| 00940 | 76100131 | M3 (5.0) | 15.0 | 0,5-2,5 | 7,0 | 0,9 | 4,9 |
| 00941 | 76100132 | M3 (5,0) | 16.0 | 2,5-4,0 | 7,0 | 0,9 | 4,9 |
| 00942 | 76100141 | M4 (6,0) | 16,0 | 0,5-3,0 | 9,0 | 1,1 | 5,9 |
| 00943 | 76100142 | M4 (6,0) | 19,0 | 3,5-5,5 | 9,0 | 1,1 | 5,9 |
| 00944 | 76100151 | M5 (7,0) | 18,5 | 0,5-3,0 | 10,0 | 1,1 | 6,9 |
| 00945 | 76100152 | M5 (7,0) | 21,5 | 3,0-5,5 | 10,0 | 1,1 | 6,9 |
| 00946 | 76100153 | M5 (7,0) | 24,5 | 5,5-8,0 | 10,1 | 1,1 | 6,9 |
| 00947 | 76100161 | M6 (9.0) | 21.5 | 0,5-3,0 | 12.0 | 1.6 | 8.9 |
| 00948 | 76100162 | M6 (9.0) | 24.0 | 3,0-5,5 | 12.0 | 1.6 | 8.9 |
| 00949 | 76100163 | M6 (9.0) | 26.5 | 5,5-8,0 | 12.0 | 1.6 | 8.9 |
| 00950 | 76100181 | M8 (11.0) | 26.0 | 0.5-3.0 | 15.0 | 1.6 | 10.9 |
| 00951 | 76100182 | M8 (11.0) | 28.5 | 3.0-5.5 | 15.0 | 1.6 | 10.9 |
| 00952 | 76100183 | M8 (11.0) | 31.0 | 5.5-8.0 | 15.0 | 1.6 | 10.9 |
| 00953 | 76100184 | M8 (11.0) | 33.5 | 8.0-10.5 | 15.0 | 1.6 | 10.9 |
| 00954 | 761001101 | M10 (12.0) | 28.0 | 0.5-3.0 | 16.0 | 2.1 | 11.9 |
| 00955 | 761001102 | M10 (12.0) | 33.0 | 3.0-6.0 | 16.0 | 2.1 | 11.9 |
| 00956 | 761001103 | M10 (12.0) | 36.0 | 6.0-9.0 | 16.0 | 2.1 | 11.9 |
| 00957 | 761001104 | M10 (12.0) | 39.0 | 9.0-12.0 | 16.0 | 2.1 | 11.9 |

DATOS MECANICOS



| METRICA |  (Nm) |  |  |
|---------|---|---|---|
| M3 | 3,0 | 4.900 | 990 |
| M4 | 4,5 | 7.840 | 1.660 |
| M5 | 7,8 | 11.070 | 2.760 |
| M6 | 20,0 | 17.640 | 3.430 |
| M8 | 29,0 | 27.440 | 4.410 |
| M10 | 32,0 | 29.400 | 4.900 |
| M12 | 43,7 | 48.020 | 6.860 |

TUERCA REMACHABLE ACERO CON CABEZA AVELLANADA - RIVET NUT COUNTERSUNK HEAD STEEL

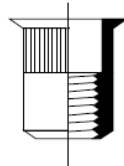
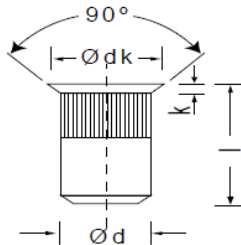

| CODIGO | REFERENCIA | METRICA mm | l mm (+0.5/ -0) | ESPESOR | dk mm (+0/- 0.5) | K ≤ mm | d mm (+0/- 0.2) |
|--------|------------|---------------|-----------------------|----------|---------------------------|--------------|--------------------------|
| 00958 | 76102031 | M3 (5.0) | 11.5 | 1,5-3,5 | 7,5 | 0,9 | 4,9 |
| 00959 | 76102032 | M3 (5,0) | 12.5 | 3,5-5,0 | 7,5 | 0,9 | 4,9 |
| 00960 | 76102041 | M4 (6,0) | 12.5 | 1,5-4,0 | 8.5 | 1,1 | 5,9 |
| 00961 | 76102042 | M4 (6,0) | 15.0 | 4,0-6,5 | 8.5 | 1,1 | 5,9 |
| 00962 | 76102051 | M5 (7,0) | 13,5 | 1,5-4,0 | 9.5 | 1,1 | 6,9 |
| 00963 | 76102052 | M5 (7,0) | 16.0 | 4,0-6,5 | 9.5 | 1,1 | 6,9 |
| 00964 | 76102053 | M5 (7,0) | 18,5 | 6,5-9,0 | 9.5 | 1,1 | 6,9 |
| 00965 | 76102061 | M6 (9.0) | 15.5 | 1,5-4,0 | 11.5 | 1.6 | 8.9 |
| 00966 | 76102062 | M6 (9.0) | 18.0 | 4,0-6,5 | 11.5 | 1.6 | 8.9 |
| 00967 | 76102063 | M6 (9.0) | 20.0 | 6,5-9,0 | 11.5 | 1.6 | 8.9 |
| 00968 | 76102081 | M8 (11.0) | 18.5 | 1.5-4.0 | 13.5 | 1.6 | 10.9 |
| 00969 | 76102082 | M8 (11.0) | 21.0 | 4.0-6.5 | 13.5 | 1.6 | 10.9 |
| 00970 | 76102083 | M8 (11.0) | 23.5 | 6.5-9.0 | 13.5 | 1.6 | 10.9 |
| 00971 | 761020101 | M10 (12.0) | 21.0 | 2.0-4.5 | 14.5 | 1.7 | 11.9 |
| 00972 | 761020102 | M10 (12.0) | 24.0 | 4.5-7.5 | 14.5 | 1.7 | 11.9 |
| 00973 | 761020103 | M10 (12.0) | 27.0 | 7.5-10.5 | 14.5 | 1.7 | 11.9 |
| 00974 | 761020121 | M12 (16.0) | 24.5 | 2.0-4.5 | 19.0 | 1.9 | 15.9 |
| 00975 | 761020122 | M12 (16.0) | 27.5 | 4.5-7.5 | 19.0 | 1.9 | 15.9 |
| 00976 | 761020123 | M12 (16.0) | 31.0 | 7.5-10.5 | 19.0 | 1.9 | 15.9 |

DATOS MECANICOS



| METRICA | (Nm) | | |
|---------|----------|--------|-------|
| M3 | 3,0 | 4.900 | 990 |
| M4 | 4,5 | 7.840 | 1.660 |
| M5 | 7,8 | 11.070 | 2.760 |
| M6 | 20,0 | 17.640 | 3.430 |
| M8 | 29,0 | 27.440 | 4.410 |
| M10 | 32,0 | 29.400 | 4.900 |
| M12 | 43,7 | 48.020 | 6.860 |

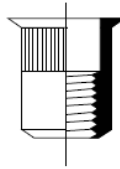
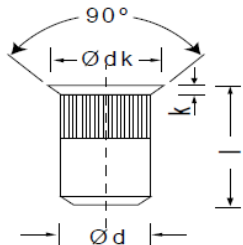

TUERCA REMACHABLE ACERO CON CABEZA AVELLANADA CIEGA – RIVET NUT COUNTERSUNK HEAD STEEL CLOSED END



| CODIGO | REFERENCIA | METRICA mm  | l mm (+0.5/-0) | ESPESOR | dk mm (+0/-0.5) | K ≤ mm | d mm (+0/-0.2) |
|--------|------------|--|-------------------|----------|-----------------------|--------------|----------------------|
| 00977 | 76102131 | M3 (5.0) | 16.0 | 1,5-3,5 | 7,5 | 0,9 | 4,9 |
| 00978 | 76102132 | M3 (5,0) | 17.0 | 3,5-5,0 | 7,5 | 0,9 | 4,9 |
| 00979 | 76102141 | M4 (6,0) | 17.5 | 1,5-4,0 | 8.5 | 1,1 | 5,9 |
| 00980 | 76102142 | M4 (6,0) | 20.0 | 4,0-6,5 | 8.5 | 1,1 | 5,9 |
| 00981 | 76102151 | M5 (7,0) | 20.0 | 1,5-4,0 | 9.5 | 1,1 | 6,9 |
| 00982 | 76102152 | M5 (7,0) | 22.5 | 4,0-6,5 | 9.5 | 1,1 | 6,9 |
| 00983 | 76102153 | M5 (7,0) | 25.0 | 6,5-9,0 | 9.5 | 1,1 | 6,9 |
| 00984 | 76102161 | M6 (9.0) | 23.0 | 1,5-4,0 | 11.5 | 1.6 | 8.9 |
| 00985 | 76102162 | M6 (9.0) | 25.5 | 4,0-6,5 | 11.5 | 1.6 | 8.9 |
| 00986 | 76102163 | M6 (9.0) | 28.0 | 6,5-9,0 | 11.5 | 1.6 | 8.9 |
| 00987 | 76102181 | M8 (11.0) | 27.0 | 1.5-4.0 | 13.5 | 1.6 | 10.9 |
| 00988 | 76102182 | M8 (11.0) | 29.5 | 4.0-6.5 | 13.5 | 1.6 | 10.9 |
| 00989 | 76102183 | M8 (11.0) | 32.0 | 6.5-9.0 | 13.5 | 1.6 | 10.9 |
| 00990 | 761021101 | M10 (13.0) | 30.0 | 2.0-4.5 | 14.5 | 1.7 | 11.9 |
| 00991 | 761021102 | M10 (13.0) | 33.0 | 4.5-7.5 | 14.5 | 1.7 | 11.9 |
| 00992 | 761021103 | M10 (13.0) | 36.0 | 7.5-10.5 | 14.5 | 1.7 | 11.9 |
| 00993 | 761021121 | M12 (16.0) | 34.5 | 2.0-4.5 | 19.0 | 1.9 | 15.9 |
| 00994 | 761021122 | M12 (16.0) | 37.5 | 4.5-7.5 | 19.0 | 1.9 | 15.9 |
| 00995 | 761021123 | M12 (16.0) | 40.5 | 7.5-10.5 | 19.0 | 1.9 | 15.9 |

DATOS MECANICOS



| METRICA |  (Nm) |  |  |
|---------|---|---|---|
| M3 | 3,0 | 4.900 | 990 |
| M4 | 4,5 | 7.840 | 1.660 |
| M5 | 7,8 | 11.070 | 2.760 |
| M6 | 20,0 | 17.640 | 3.430 |
| M8 | 29,0 | 27.440 | 4.410 |
| M10 | 32,0 | 29.400 | 4.900 |
| M12 | 43,7 | 48.020 | 6.860 |

TUERCA REMACHABLE ACERO SIN CABEZA

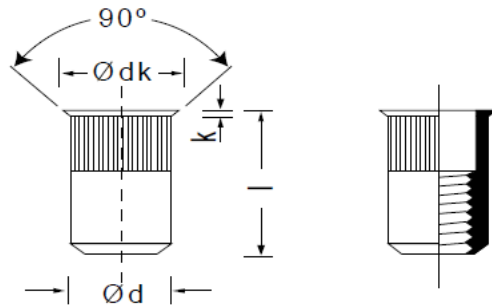

RIVET NUT REDUCED HEAD STEEL



| CODIGO | REFERENCIA | METRICA mm  | l mm (+0.5/ -0) | ESPESOR | dk mm (+0/- 0.5) | K ≤ mm | d mm (+0/- 0.2) |
|--------|------------|--|-----------------------|---------|------------------------|--------------|-----------------------|
| 00996 | 76103031 | M3 (5.0) | 9,5 | 0,5-2,5 | 6,0 | 0,7 | 4,9 |
| 00997 | 76103041 | M4 (6.0) | 10,0 | 0,5-3,0 | 7,0 | 0,7 | 5,9 |
| 00998 | 76103051 | M5 (7.0) | 11,5 | 0,5-3,0 | 8,0 | 0,7 | 6,9 |
| 00999 | 76103061 | M6 (9.0) | 14,0 | 0,5-3,0 | 10,0 | 0,7 | 8,9 |
| 01000 | 76103081 | M8 (11.0) | 15,5 | 0,5-3,0 | 12,0 | 0,7 | 10,9 |
| 01001 | 76103010 | M10(12.0) | 19,5 | 0,8-3,5 | 13,5 | 0,9 | 11,9 |

DATOS MECANICOS



| METRICA |  (Nm) |  |  |
|---------|---|---|---|
| M3 | 3,0 | 3.900 | 900 |
| M4 | 4,0 | 6.470 | 1.620 |
| M5 | 5,0 | 9.090 | 2.190 |
| M6 | 15,0 | 16.660 | 2.350 |
| M8 | 18,0 | 21.610 | 2.840 |
| M10 | 30,5 | 31.750 | 4.260 |

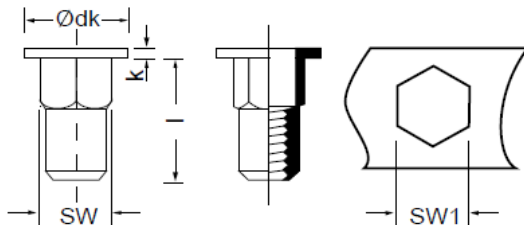

TUERCA REMACHABLE ACERO CON CABEZA SEMIHEXAGONAL - RIVET NUT FLAT HEAD STEEL SEMI-HEX



| CODIGO | REFERENCIA | METRICA mm | l mm (+0.5/ -0) | ESPEJOR | dk mm (+0/- 0.5) | K ≤ mm | d mm (+0/- 0.2) |
|--------|------------|---------------|-----------------------|---------|------------------------|--------------|-----------------------|
| 01002 | 76140041 | M4 (7.1) | 13.0 | 0.5-3.0 | 9.5 | 1.1 | 6.0 |
| 01003 | 76140051 | M5 (7.1) | 14.5 | 0.5-3.0 | 10.5 | 1.1 | 7.0 |
| 01004 | 76140061 | M6 (9.1) | 17.0 | 0.5-3.0 | 12.5 | 1.6 | 14.0 |
| 01005 | 76140081 | M8 (11.1) | 19.0 | 0.5-3.0 | 14.5 | 1.6 | 22.0 |
| 01006 | 76140010 | M10 (13.1) | 24.0 | 0.8-4.0 | 16.5 | 2.1 | 35.0 |

DATOS MECANICOS



| METRICA |  (Nm) |  |  |
|---------|---|---|---|
| M4 | 5.0 | 4.900 | 3.400 |
| M5 | 7.0 | 8.800 | 1.900 |
| M6 | 14.0 | 16.600 | 2.900 |
| M8 | 22.0 | 21.500 | 3.000 |
| M10 | 35.0 | 29.400 | 3.400 |

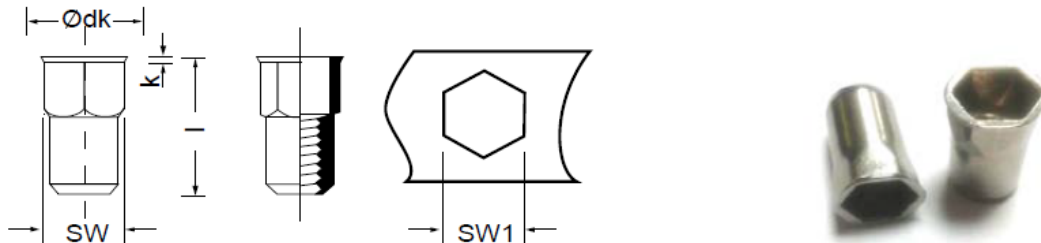

TUERCA REMACHABLE ACERO SIN CABEZA SEMIHEXAGONAL - RIVET NUT REDUCED HEAD STEEL SEMI-HEX



| CODIGO | REFERENCIA | METRICA mm  | l mm (+0.5/ -0) | ESPESOR | dk mm (+0/- 0.5) | K mm | sw mm (+0/- 0.2) |
|--------|------------|--|-----------------------|---------|---------------------------|---------|---------------------------|
| 01007 | 76143031 | M3 (5.1) | 10,5 | 0,5-2,5 | 6,5 | 0,8 | 5,0 |
| 01008 | 76143041 | M4 (6.1) | 12,5 | 0,5-3,0 | 7,0 | 0,8 | 6,0 |
| 01009 | 76143051 | M5 (7.1) | 14,0 | 0,5-3,0 | 8,0 | 0,8 | 7,0 |
| 01010 | 76143061 | M6 (9.1) | 16,0 | 0,5-3,0 | 10,0 | 0,8 | 9,0 |
| 01011 | 76143081 | M8 (11.1) | 17,0 | 0,5-3,0 | 12,0 | 0,8 | 11,0 |
| 01012 | 76143010 | M10(13.1) | 20,5 | 0,8-4,0 | 14,5 | 0,8 | 13,0 |

DATOS MECANICOS



| METRICA |  (Nm) |  |  |
|---------|---|---|---|
| M4 | 3,0 | 2.900 | 900 |
| M5 | 5,0 | 3.530 | 1.470 |
| M6 | 7,0 | 4.900 | 1.760 |
| M7 | 14,0 | 14.700 | 2.940 |
| M8 | 21,0 | 21.560 | 3.020 |
| M10 | 35,0 | 29.400 | 3.400 |

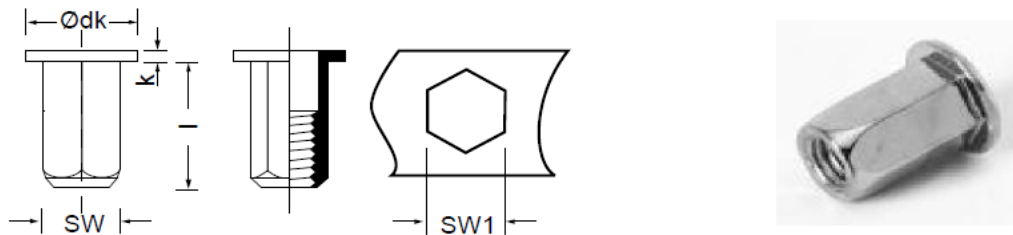

TUERCA REMACHABLE ACERO CON CABEZA HEXAGONAL

- RIVET NUT FLAT HEAD STEEL HEXAGON BODY





| CODIGO | REFERENCIA | METRICA mm  | l mm (+0.5/-0) | ESPEJOR | dk mm (+0/-0.5) | K ≤ mm | sw mm (+0/-0.2) |
|--------|------------|--|-------------------|---------|-----------------------|--------------|-----------------------|
| 01013 | 76150041 | M4 (7.1) | 13,0 | 0,5-3,0 | 9,5 | 1,1 | 6,0 |
| 01014 | 76150051 | M5 (7.1) | 14,5 | 0,5-3,0 | 10,5 | 1,1 | 7,0 |
| 01015 | 76150061 | M6 (9.1) | 17,0 | 0,5-3,0 | 12,5 | 1,6 | 9,0 |
| 01016 | 76150081 | M8 (11.1) | 19,0 | 0,5-3,0 | 14,5 | 1,6 | 11,0 |
| 01017 | 76150010 | M10(13.1) | 24,0 | 0,8-4,0 | 16,5 | 2,1 | 13,0 |

DATOS MECANICOS →

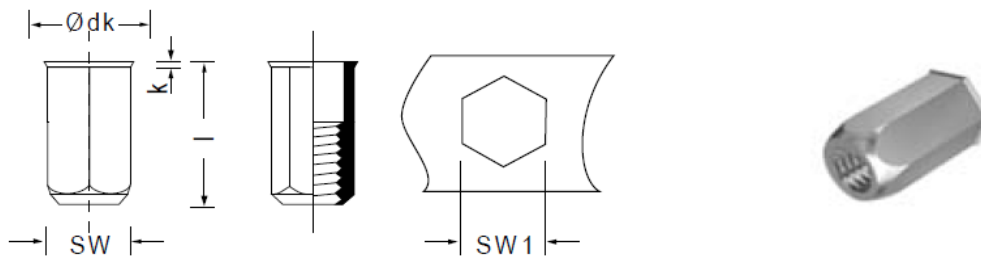

| METRICA |  (Nm) |  |  |
|---------|---|---|---|
| M4 | 5,0 | 4.900 | 3.400 |
| M5 | 7,0 | 8.800 | 1.900 |
| M6 | 14,0 | 16.600 | 2.900 |
| M8 | 22,0 | 21.500 | 3.000 |
| M10 | 35,0 | 29.400 | 3.400 |

TUERCA REMACHABLE ACERO SIN CABEZA
HEXAGONAL — RIVET NUT REDUCED HEAD STEEL HEXAGON BODY



| CODIGO | REFERENCIA | METRICA mm  | l mm (+0.5/-0) | ESPEJOR | DK mm (+0/-0.5) | K ≤ mm | SW mm (+0/-0.2) |
|--------|------------|--|-------------------|---------|--------------------|--------------|-----------------------|
| 01018 | 76153041 | M4 (7.1) | 13,0 | 0,5-3,0 | 9,5 | 1,1 | 6,0 |
| 01019 | 76153051 | M5 (7.1) | 14,5 | 0,5-3,0 | 10,5 | 1,1 | 7,0 |
| 01020 | 76153061 | M6 (9.1) | 17,0 | 0,5-3,0 | 12,5 | 1,6 | 9,0 |
| 01021 | 76153081 | M8 (11.1) | 19,0 | 0,5-3,0 | 14,5 | 1,6 | 11,0 |
| 01022 | 76153010 | M10(13.1) | 24,0 | 0,8-4,0 | 16,5 | 2,1 | 13,0 |

DATOS MECANICOS

| METRICA |  (Nm) |  |  |
|---------|---|---|---|
| M4 | 5,0 | 4.900 | 3.400 |
| M5 | 7,0 | 8.800 | 1.900 |
| M6 | 14,0 | 16.600 | 2.900 |
| M8 | 22,0 | 21.500 | 3.000 |
| M10 | 35,0 | 29.400 | 3.400 |

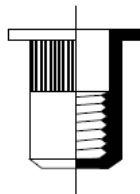
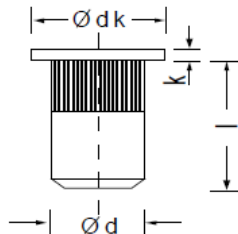

TUERCA REMACHABLE INOX CON CABEZA

RIVET NUT FLAT HEAD STAINLESS STEEL



| CODIGO | REFERENCIA | METRICA mm  | l mm (+0.5/ -0) | ESPESOR | Dk mm (+0/ -0.5) | K ≤ mm | d mm (+0/-0.2) |
|--------|------------|--|-----------------------|---------|---------------------------|--------------|-------------------|
| 01023 | 76200041 | M4 (6.0) | 11.0 | 0.5-3.0 | 9.0 | 1.1 | 5.9 |
| 01024 | 76200042 | M4 (6.0) | 14.0 | 3.0-4.5 | 9.0 | 1.1 | 5.9 |
| 01025 | 76200051 | M5 (7.0) | 13.0 | 0.5-3.0 | 10.0 | 1.1 | 6.9 |
| 01026 | 76200052 | M5 (7.0) | 16.0 | 3.0-5.5 | 10.0 | 1.1 | 6.9 |
| 01027 | 76200053 | M5 (7.0) | 19.0 | 5.5-8.0 | 10.0 | 1.1 | 6.9 |
| 01028 | 76200061 | M6 (9.0) | 16.0 | 0.5-3.0 | 12.0 | 1.6 | 8.9 |
| 01029 | 76200062 | M6 (9.0) | 18.5 | 3.0-5.5 | 12.0 | 1.6 | 8.9 |
| 01030 | 76200081 | M8 (11.0) | 17.5 | 0.5-3.0 | 15.0 | 1.6 | 10.9 |
| 01031 | 76200082 | M8 (11.0) | 20.0 | 3.0-5.5 | 15.0 | 1.6 | 10.9 |
| 01032 | 762000101 | M10(13.0) | 19.0 | 0.5-3.0 | 16.0 | 2.1 | 12.9 |
| 01033 | 762000102 | M10(13.0) | 24.0 | 3.0-6.0 | 16.0 | 2.1 | 12.9 |

DATOS MECANICOS

| METRICA |  (Nm) |  |  |
|---------|---|---|---|
| M4 | 7.0 | 7.800 | 2.600 |
| M5 | 12.0 | 11.760 | 3.920 |
| M6 | 22.2 | 20.580 | 5.630 |
| M8 | 30.5 | 26.460 | 7.800 |
| M10 | 39.0 | 35.280 | 8.800 |

*TAMBIEN DISPONIBLES EN CIEGAS

TUERCA REMACHABLE INOX CON CABEZA AVELLANADA — **RIVET NUT COUNTERSUNK HEAD STAINLESS STEEL**

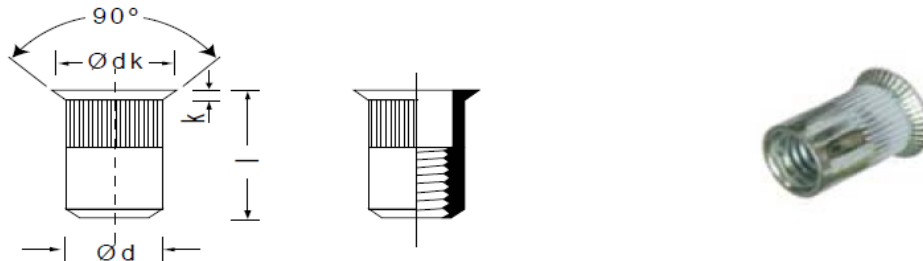

| CODIGO | REFERENCIA | METRICA mm | l mm (+0.5/ -0) | ESPELOR | dk mm (+0/-0.5) | K ≤ mm | d mm (+0/ -0.2) |
|--------|------------|---------------|-----------------------|---------|--------------------|--------------|-----------------------|
| 01034 | 76202031 | M3 (5.0) | 11.5 | 1.5-3.5 | 7.5 | 1.5 | 4.9 |
| 01035 | 76202032 | M3 (5.0) | 12.5 | 3.5-4.5 | 7.5 | 1.5 | 4.9 |
| 01036 | 76202041 | M4 (6.0) | 12.5 | 1.5-4.0 | 8.5 | 1.5 | 5.9 |
| 01037 | 76202051 | M5 (7.0) | 13.0 | 1.5-4.0 | 9.5 | 1.5 | 6.9 |
| 01038 | 76202052 | M5 (7.0) | 16.0 | 4.0-6.5 | 9.5 | 1.5 | 6.9 |
| 01039 | 76202061 | M6 (9.0) | 15.5 | 1.5-4.0 | 11.5 | 1.5 | 8.9 |
| 01040 | 76202062 | M6 (9.0) | 18.0 | 4.0-6.5 | 11.5 | 1.5 | 8.9 |
| 01041 | 76202081 | M8 (11.0) | 18.5 | 1.5-4.0 | 13.5 | 1.5 | 10.9 |
| 01042 | 76202082 | M8 (11.0) | 21.0 | 4.0-6.5 | 13.5 | 1.5 | 10.9 |
| 01043 | 762020101 | M10(13.0) | 21.0 | 2.0-4.5 | 15.5 | 1.8 | 12.9 |
| 01044 | 762020102 | M10(13.0) | 24.0 | 4.5-7.5 | 15.5 | 1.8 | 12.9 |
| 01045 | 762020121 | M12(16.0) | 24.5 | 2.0-4.5 | 19.0 | 2.0 | 15.9 |
| 01046 | 762020122 | M12(16.0) | 27.5 | 4.5-7.5 | 19.0 | 2.0 | 15.9 |

DATOS MECANICOS

| METRICA | ↑ (Nm) | ↕ | ↔ |
|---------|-----------|--------|-------|
| M3 | 3.5 | 5.800 | 1.400 |
| M4 | 9.0 | 10.130 | 3.720 |
| M5 | 10.5 | 12.250 | 4.020 |
| M6 | 21.0 | 20.580 | 5.560 |
| M8 | 31.0 | 30.840 | 7.640 |
| M10 | 33.0 | 34.300 | 8.110 |
| M12 | 50.0 | 59.900 | 9.800 |

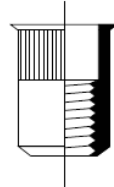
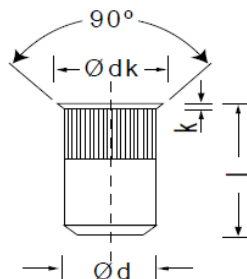

TUERCA REMACHABLE INOX SIN CABEZA

RIVET NUT REDUCED COUNTERSUNK STAINLESS STEEL





| CODIGO | REFERENCIA | METRICA mm  | l mm (+0.5/ -0) | ESPESOR | dk mm (+0/- 0.5) | K ≤ mm | d mm (+0/-0.2) |
|--------|------------|--|-----------------------|---------|---------------------------|--------------|-------------------|
| 01047 | 76203041 | M4 (6.0) | 10.0 | 0-5.2.5 | 7.0 | 0.9 | 5.9 |
| 01048 | 76203051 | M5 (7.0) | 11.5 | 0.5-3.0 | 8.0 | 0.9 | 6.9 |
| 01049 | 76203061 | M6 (9.0) | 14.0 | 0.5-3.0 | 10.0 | 0.9 | 8.9 |
| 01050 | 76203081 | M8 (11.0) | 15.5 | 0.5-3.0 | 12.0 | 0.9 | 10.9 |
| 01051 | 76203010 | M10(13.0) | 19.5 | 0.8-3.5 | 14.5 | 1.1 | 12.9 |

DATOS MECANICOS

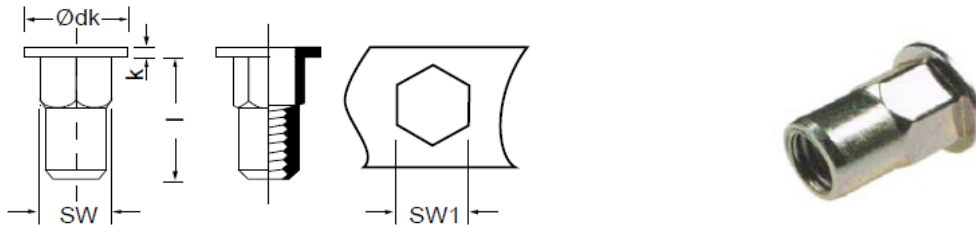

| METRICA |  (Nm) |  |  |
|---------|---|---|---|
| M4 | 9.0 | 9.860 | 2.940 |
| M5 | 10.5 | 11.760 | 4.030 |
| M6 | 21.0 | 18.620 | 5.230 |
| M8 | 31.0 | 25.480 | 5.400 |
| M10 | 32.0 | 33.320 | 5.880 |

TUERCA REMACHABLE INOX CON CABEZA SEMIHEXAGONAL - RIVET NUT FLAT HEAD STAINLESS STEEL SEMI-HEX.





| CODIGO | REFERENCIA | METRICA mm  | l mm (+0.5/-0) | ESPEJOR | dk mm (+0/-0.5) | K ≤ mm | SW mm (+0/-0.2) |
|--------|------------|--|-------------------|---------|-----------------------|--------------|--------------------|
| 01052 | 76240041 | M4 (6.1) | 11.5 | 0.5-2.5 | 9.3 | 1.1 | 6.0 |
| 01053 | 76240051 | M5 (7.1) | 13.5 | 0.5-3.0 | 10.3 | 1.1 | 7.0 |
| 01054 | 76240061 | M6 (9.1) | 15.5 | 0.5-3.0 | 12.3 | 1.6 | 9.0 |
| 01055 | 76240081 | M8 (11.1) | 17.5 | 0.5-3.0 | 14.3 | 1.6 | 11.0 |
| 01056 | 76240010 | M10(13.1) | 24.0 | 0.8-4.0 | 16.3 | 2.1 | 13.0 |

DATOS MECANICOS →

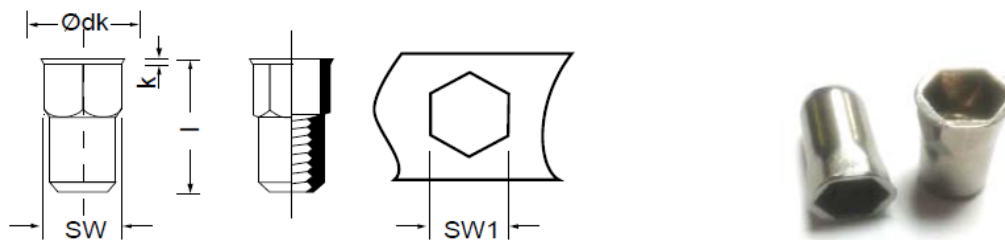

| METRICA |  (Nm) |  |  |
|---------|---|---|---|
| M4 | 12.0 | 10.190 | 2.680 |
| M5 | 14.0 | 12.740 | 3.430 |
| M6 | 26.0 | 19.600 | 4.700 |
| M8 | 39.0 | 37.420 | 6.680 |
| M10 | 45.0 | 63.700 | 7.840 |

TUERCA REMACHABLE INOX SIN CABEZA SEMIHEXAGONAL — RIVET NUT REDUCED HEAD STAINLESS STEEL SEMI-HEX.



| CODIGO | REFERENCIA | METRICA mm  | l mm (+0.5/ -0) | ESPESOR | dk mm (+0/ -0.5) | K mm ≤ | SW mm (+0/-0.2) |
|--------|------------|--|-----------------------|---------|---------------------------|--------------|--------------------|
| 01057 | 76243041 | M4 (6.0) | 12.5 | 0.5-2.5 | 7.0 | 0.9 | 6.0 |
| 01058 | 76243051 | M5 (7.0) | 14.0 | 0.5-3.0 | 8.0 | 0.9 | 7.0 |
| 01059 | 76243061 | M6 (9.0) | 16.0 | 0.5-3.0 | 10.0 | 0.9 | 9.0 |
| 01060 | 76243081 | M8 (11.0) | 17.0 | 0.5-3.0 | 12.0 | 0.9 | 11.0 |
| 01061 | 76243010 | M10(13.0) | 20.5 | 0.8-4.0 | 14.5 | 1.1 | 13.0 |

DATOS MECANICOS →

| METRICA |  (Nm) |  |  |
|---------|---|---|---|
| M4 | 12.0 | 8.240 | 2.950 |
| M5 | 12.0 | 11.760 | 2.950 |
| M6 | 21.0 | 21.560 | 3.820 |
| M8 | 30.0 | 24.500 | 3.920 |
| M10 | 40.0 | 47.040 | 5.010 |

TUERCA REMACHABLE INOX A4 CON CABEZA

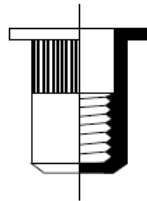
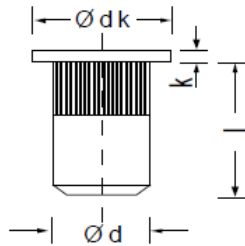

RIVET NUT FLAT HEAD STAINLESS STEEL A4



| CODIGO | REFERENCIA | METRICA mm  | l mm (+0/-1.3) | ESPESOR | Dk mm (+0/-0.6) | K ≤ mm | d mm (+0/-0.2) |
|--------|------------|---|-------------------|---------|-----------------------|--------------|-------------------|
| 01062 | 76300051 | M5 (7,0) | 13,0 | 0,5-3,0 | 10,0 | 1,1 | 6,9 |
| 01063 | 76300061 | M6 (9,0) | 16,0 | 0,5-3,0 | 12,0 | 1,6 | 8,9 |
| 01064 | 76300081 | M8 (11,0) | 17,5 | 0,5-3,0 | 15,0 | 1,6 | 10,9 |

DATOS MECANICOS



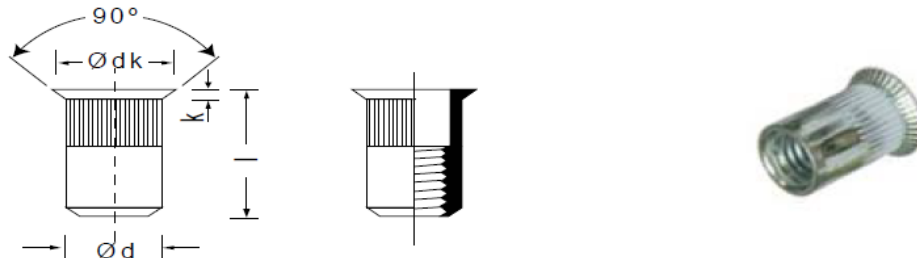

| METRICA |  (Nm) |  |  |
|---------|---|---|---|
| M5 | 12.00 | 11.760 | 3.920 |
| M6 | 22.2 | 20.580 | 5.630 |
| M8 | 30,5 | 26.460 | 7.800 |

TUERCA REMACHABLE INOX A4 CABEZA AVELLANDA – RIVET NUT COUNTERSUNK HEAD STAINLESS STEEL A4



| CODIGO | REFERENCIA | METRICA mm  | l mm (+0/ -1.3) | ESPESOR | dk mm (+0/ -0.6) | K mm | dmm (+0/ -0.2) |
|--------|------------|--|-----------------------|---------|---------------------------|---------|----------------------|
| 01065 | 76302061 | M5 (7.0) | 13,5 | 1,5-4,0 | 10,0 | 1,5 | 6,9 |
| 01066 | 76302061 | M6 (9,0) | 15,5 | 1,5-4,0 | 12,0 | 1,5 | 8,9 |
| 01067 | 76302081 | M8(11,0) | 18,5 | 1,5-4,0 | 15,0 | 1,5 | 10,9 |

DATOS MECANICOS →

| METRICA |  (Nm) |  |  |
|---------|---|---|---|
| M5 | 10.5 | 12.250 | 4.020 |
| M6 | 21.0 | 20.580 | 5.560 |
| M8 | 31,0 | 30.840 | 7.640 |

TUERCA REMACHABLE ALUMINIO CON CABEZA

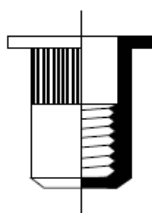
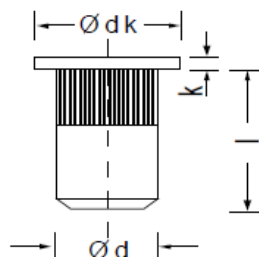



RIVET NUT FLAT HEAD ALUMINUM



| CODIGO | REFERENCIA | METRICA mm  | l mm (+0.5/ -0) | ESPESOR | DKmm (+0/- 0.5) | K ≤ mm | d mm (+0/- 0.2) |
|--------|------------|--|-----------------------|----------|-----------------------|--------------|--------------------------|
| 01068 | 76400031 | M3 (5.0) | 10.5 | 0.5-2.5 | 7,0 | 0,9 | 4,9 |
| 01069 | 76400032 | M3 (5,0) | 11.5 | 2.5-3.5 | 7,0 | 0,9 | 4,9 |
| 01070 | 76400041 | M4 (6,0) | 11.0 | 0.5-3.0 | 9,0 | 1,1 | 5,9 |
| 01071 | 76400042 | M4 (6,0) | 14.0 | 3.0-4.5 | 9,0 | 1,1 | 5,9 |
| 01072 | 76400051 | M5 (7,0) | 13.0 | 0.5-3.0 | 10,0 | 1,1 | 6,9 |
| 01073 | 76400052 | M5 (7,0) | 16.0 | 3.0-5.5 | 10,0 | 1,1 | 6,9 |
| 01074 | 76400053 | M5 (7,0) | 19.0 | 5.5-8.8 | 10,0 | 1,1 | 6,9 |
| 01075 | 76400061 | M6 (9,0) | 16.0 | 0.5-3.0 | 12,0 | 1,6 | 8,9 |
| 01076 | 76400062 | M6 (9,0) | 18.5 | 3.0-5.5 | 12,0 | 1,6 | 8,9 |
| 01077 | 76400063 | M6 (9,0) | 21.0 | 5.5-8.8 | 12,0 | 1,6 | 8,9 |
| 01078 | 76400081 | M8 (11,0) | 17.5 | 0.5-3.0 | 15,0 | 1,6 | 10,9 |
| 01079 | 76400082 | M8 (11,0) | 20.0 | 3.0-5.5 | 15,0 | 1,6 | 10,9 |
| 01080 | 76400083 | M8 (11,0) | 22.5 | 5.5-8.0 | 15,0 | 1,6 | 10,9 |
| 01081 | 76400084 | M8 (11,0) | 25.0 | 8.0-10.5 | 15,0 | 1,6 | 10,9 |
| 01082 | 764000101 | M10 (12,0) | 19.0 | 0.8-3.0 | 16,0 | 2,1 | 11,9 |
| 01083 | 764000102 | M10 (12,0) | 24.0 | 3.0-6.0 | 16,0 | 2,1 | 11,9 |
| 01084 | 764000103 | M10 (12,0) | 27.0 | 6.0-9.0 | 16,0 | 2,1 | 11,9 |
| 01085 | 764000104 | M10 (12,0) | 30.0 | 9.0-12.0 | 16,0 | 2,1 | 11,9 |
| 01086 | 764000121 | M12 (16,0) | 25.0 | 1.0-4.0 | 22,0 | 2,1 | 15,9 |
| 01087 | 764000122 | M12 (16,0) | 28.0 | 4.0-7.0 | 22,0 | 2,1 | 15,9 |
| 01088 | 764000123 | M12 (16,0) | 31.0 | 7.0-10.0 | 22,0 | 2,1 | 15,9 |

DATOS MECANICOS



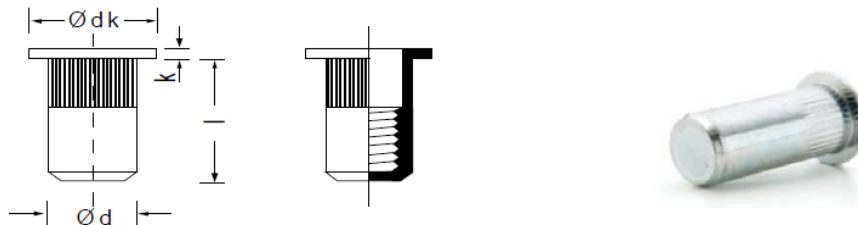

| METRICA |  (Nm) |  |  |
|---------|---|---|---|
| M3 | 2,0 | 2.000 | 700 |
| M4 | 4,0 | 2.840 | 1.070 |
| M5 | 5,0 | 4.900 | 1.170 |
| M6 | 14,6 | 9.300 | 2.280 |
| M8 | 14,6 | 14.750 | 2.450 |
| M10 | 20,0 | 21.500 | 3.820 |
| M12 | 23,0 | 27.400 | 4.400 |

TUERCA REMACHABLE ALUMINIO CON CABEZA CIEGAS — RIVET NUT FLAT HEAD ALLUMINIUM CLOSED END



| CODIGO | REFERENCIA | METRICA mm  | l mm (+0.5/-0) | ESPELOR | D2 mm (+0/-0.5) | K ≤ mm | D1 mm (+0/-0.2) |
|--------|------------|--|-------------------|----------|-----------------------|--------------|-----------------------|
| 01089 | 76400131 | M3 (5.0) | 15.0 | 0,5-2,5 | 7,0 | 0,9 | 4,9 |
| 01090 | 76400132 | M3 (5,0) | 16.0 | 2,5-3.5 | 7,0 | 0,9 | 4,9 |
| 01091 | 76400141 | M4 (6,0) | 16,0 | 0,5-3,0 | 9,0 | 1,1 | 5,9 |
| 01092 | 76400142 | M4 (6,0) | 19,0 | 3,5-4,5 | 9,0 | 1,1 | 5,9 |
| 01093 | 76400151 | M5 (7,0) | 18,5 | 0,5-3,0 | 10,0 | 1,1 | 6,9 |
| 01094 | 76400152 | M5 (7,0) | 21,5 | 3,0-5,5 | 10,0 | 1,1 | 6,9 |
| 01095 | 76400153 | M5 (7,0) | 24,5 | 5,5-8,0 | 10,1 | 1,1 | 6,9 |
| 01096 | 76400161 | M6 (9.0) | 21.5 | 0,5-3,0 | 12.0 | 1.6 | 8.9 |
| 01097 | 76400162 | M6 (9.0) | 24.0 | 3,0-5,5 | 12.0 | 1.6 | 8.9 |
| 01098 | 76400163 | M6 (9.0) | 26.5 | 5,5-8,0 | 12.0 | 1.6 | 8.9 |
| 01099 | 76400181 | M8 (11.0) | 26.0 | 0.5-3.0 | 15.0 | 1.6 | 10.9 |
| 01100 | 76400182 | M8 (11.0) | 28.5 | 3.0-5.5 | 15.0 | 1.6 | 10.9 |
| 01101 | 76400183 | M8 (11.0) | 31.5 | 5.5-8.0 | 15.0 | 1.6 | 10.9 |
| 01102 | 76400184 | M8 (11.0) | 33.5 | 8.0-10.5 | 15.0 | 1.6 | 10.9 |
| 01103 | 764001101 | M10 (12.0) | 28.0 | 0.5-3.0 | 16.0 | 2.1 | 11.9 |
| 01104 | 764001102 | M10 (12.0) | 33.0 | 3.0-6.0 | 16.0 | 2.1 | 11.9 |
| 01105 | 764001103 | M10 (12.0) | 36.0 | 6.0-9.0 | 16.0 | 2.1 | 11.9 |
| 01106 | 764001104 | M10 (12.0) | 39.0 | 9.0-12.0 | 16.0 | 2.1 | 11.9 |

DATOS MECANICOS →

| METRICA |  (Nm) |  |  |
|---------|---|---|---|
| M3 | 2,0 | 2.000 | 700 |
| M4 | 4,0 | 2.800 | 1.000 |
| M5 | 5,0 | 4.900 | 1.100 |
| M6 | 11,0 | 9.300 | 2.200 |
| M8 | 14,6 | 14.700 | 2.400 |
| M10 | 19,9 | 21.500 | 3.800 |

TUERCA REMACHABLE ALUMINIO CABEZA
AVELLANADA — RIVET NUT COUNTERSUN ALLUMINIUM

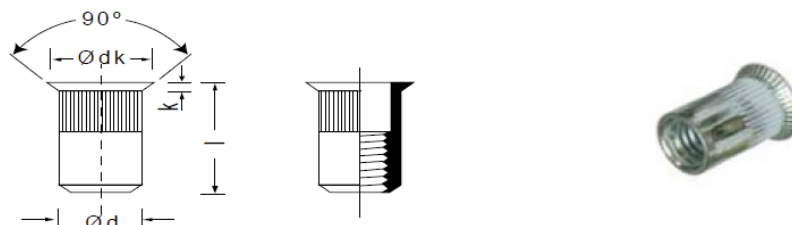

| CODIGO | REFERENCIA | METRICA mm | l mm (+0.5/ -0) | ESPEJOR | dk mm (+0.2/ -0.5) | K < mm | d mm (+0/ -0.2) |
|--------|------------|---------------|-----------------------|----------|--------------------------|--------------|-----------------------|
| 01107 | 76402031 | M3 (5.0) | 11,5 | 1,5-3,5 | 7,5 | 1,5 | 4,9 |
| 01108 | 76402032 | M3 (5.0) | 12,5 | 3,5-4,5 | 7,5 | 1,5 | 4,9 |
| 01109 | 76402041 | M4 (6.0) | 12,5 | 1,5-4,0 | 8,5 | 1,5 | 5,9 |
| 01110 | 76402042 | M4 (6.0) | 15,0 | 4,0-5,5 | 8,5 | 1,5 | 5,9 |
| 01111 | 76402051 | M5 (7.0) | 13,5 | 1,5-4,0 | 9,5 | 1,5 | 6,9 |
| 01112 | 76402052 | M5 (7.0) | 16,0 | 4,0-6,5 | 9,5 | 1,5 | 6,9 |
| 01113 | 76402053 | M5 (7.0) | 18,5 | 6,5-9,0 | 9,5 | 1,5 | 6,9 |
| 01114 | 76402061 | M6 (9.0) | 15,5 | 1,5-4,0 | 11,5 | 1,5 | 8,9 |
| 01115 | 76402032 | M6 (9.0) | 18,0 | 4,0-6,5 | 11,5 | 1,5 | 8,9 |
| 01116 | 76402063 | M6 (9.0) | 20,5 | 6,5-9,0 | 11,5 | 1,5 | 8,9 |
| 01117 | 76402081 | M8 (11.0) | 18,5 | 1,5-4,0 | 13,5 | 1,5 | 10,9 |
| 01118 | 76402082 | M8 (11.0) | 21,0 | 4,0-6,5 | 13,5 | 1,5 | 10,9 |
| 01119 | 76402083 | M8 (11.0) | 23,5 | 6,5-9,0 | 13,5 | 1,5 | 10,9 |
| 01120 | 764020101 | M10(12.0) | 21.0 | 2.5-4.5 | 14.5 | 1.7 | 11.9 |
| 01121 | 764020102 | M10(12.0) | 24.0 | 4.5-7.5 | 14.5 | 1.7 | 11.9 |
| 01122 | 764020103 | M10(12.0) | 27.0 | 7.5-10.5 | 14.5 | 1.7 | 11.9 |
| 01123 | 764020121 | M12(16.0) | 24.5 | 2.5-4.5 | 19.0 | 1.9 | 15.9 |
| 01124 | 764020122 | M12(16.0) | 27.5 | 4.5-7.5 | 19.0 | 1.9 | 15.9 |
| 00125 | 764020123 | M12(16.0) | 31.0 | 7.5-10.5 | 19.0 | 1.9 | 15.9 |

DATOS MECANICOS



| METRICA | (Nm) | ↑ ↓ | ↔ |
|---------|------|--------|-------|
| M3 | 2,0 | 2.000 | 700 |
| M4 | 4,0 | 2.840 | 1.070 |
| M5 | 5,0 | 4.900 | 1.170 |
| M6 | 11,3 | 9.300 | 2.280 |
| M8 | 14,6 | 14.700 | 2.400 |
| M10 | 20,0 | 21.500 | 3.820 |
| M12 | 23,0 | 27.400 | 4.400 |

TUERCA REMACHABLE ALUMINIO SIN CABEZA

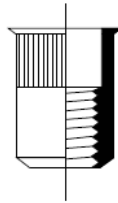
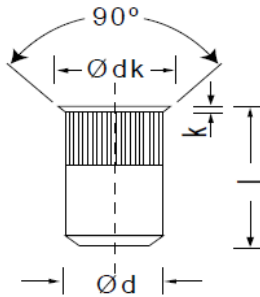

RIVET NUT REDUCED COUNTERSUNK ALLUMINIUM



| CODIGO | REFERENCIA | METRICA mm  | l mm (+0.5/ -0) | ESPESOR | dk mm (+0/- 0.5) | K ≤ mm | d mm (+0/-0.2) |
|--------|------------|--|-----------------------|---------|------------------------|--------------|-------------------|
| 01126 | 76403031 | M3 (5.0) | 9,5 | 0,5-2,5 | 6,0 | 0,7 | 4,9 |
| 01127 | 76403041 | M4 (6.0) | 10,0 | 0,5-3,0 | 7,0 | 0,7 | 5,9 |
| 01128 | 76403051 | M5 (7.0) | 11,5 | 0,5-3,0 | 8,0 | 0,7 | 6,9 |
| 01129 | 76403061 | M6 (9.0) | 14,0 | 0,5-3,0 | 10,0 | 0,7 | 8,9 |
| 01130 | 76403081 | M8 (11.0) | 15,5 | 0,5-3,0 | 12,0 | 0,7 | 10,9 |

DATOS MECANICOS



| METRICA |  (Nm) |  |  |
|---------|---|---|---|
| M3 | 2,0 | 1.700 | 700 |
| M4 | 4,0 | 2.840 | 1.080 |
| M5 | 4,5 | 5.250 | 1.180 |
| M6 | 9,6 | 9.680 | 1.960 |
| M8 | 10,9 | 15.680 | 2.060 |

REMACHADORAS PARA REMACHES MANUALES, OLENEUMATICAS Y BATERIA



REMACHADORAS MANUALES PARA REMACHES**MODELO C4 – REFERENCIA 7000C4 – CODIGO 30001**

| DIAMETRO | REM. STANDARD | ACERO | INOX |
|----------|---------------|-------|------|
| 2.4 | X | X | X |
| 3 | X | X | X |
| 3.2 | X | X | X |
| 4 | X | X | X |
| 4.8 | X | X | X |



PESO: 510 gramos

MODELO R6 – REFERENCIA 7000R6 – CODIGO 30006

| DIAMETRO | REM. STANDARD | ACERO | INOX |
|----------|---------------|-------|------|
| 2.4 | X | X | X |
| 3 | X | X | X |
| 3.2 | X | X | X |
| 4 | X | X | X |
| 4.8 | X | X | X |
| 6 | X | X | X |
| 6.4 | X | X | X |



PESO: 1.810 gramos

MODELO X7 – REFERENCIA 7000X7 – CODIGO 30005

| DIAMETRO | REM. STANDARD | ACERO | INOX |
|----------|---------------|-------|------|
| 2.4 | X | X | X |
| 3 | X | X | X |
| 3.2 | X | X | X |
| 4 | X | X | X |
| 4.8 | X | X | X |
| 6 | X | X | X |
| 6.4 | X | X | X |

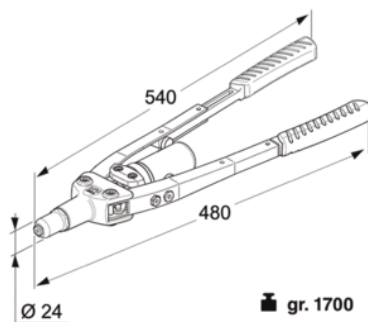
**PESO: 1.930 gramos****MODELO RRK33F – REFERENCIA 7000K33F – CODIGO 01328****REMACHADORA MANUAL PARA REMACHE ESTRUCTURAL****REMACHADORA**para la instalación de Farbolt, Tamp y otros remaches estructurales con \varnothing 4,8 y \varnothing 6,4.**EL K33F**

es una máquina con palancas telescópicas alargables diseñadas para aumentar la relación de palanca y, por tanto, disminuir el esfuerzo para posar el remache.

REMACHADORA OLENEUMATICA REMACHES

MODELO RR210 – REFERENCIA 7000RR210 – CODIGO 30018

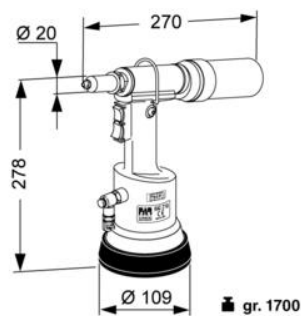

Remachadora oleoneumática con retención del remache y recuperación del vástago para remaches en todas las aleaciones Ø 2.4-5 (Ø solo en aluminio)

Remaches estándar Ø 4,8 sólo en aluminio.

| DIAMETRO | REM.STANDARD |
|----------|--------------|
| 2.4 | X |
| 3 | X |
| 3.2 | X |
| 4 | X |
| 4.8 | X |

REMACHADORA OLENEUMATICA REMACHES

MODELO RR181– REFERENCIA 7000RR180 – CODIGO 30021

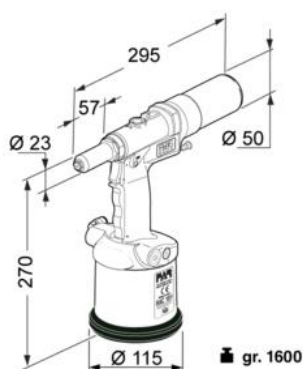

REMACHADORA OLEONEUMATICA

con sistema de seguridad para la recuperación del vástago, diseñada para colocación de remaches estándar de 2,4 à 6 mm (Ø 6 de aluminio) y remaches de alto rendimiento hasta 4,8 mm de diámetro.

LA REMACHADORA

con un peso de 1,6 kg, puede suministrar una fuerza de 10600N con una carrera de 20,5 mm. Luz y ergonómica, equipada con una conexión para el aire comprimido en ambos lados de la herramienta

| DIAMETRO | REM.STANDARD |
|----------|--------------|
| 2.4 | X |
| 3 | X |
| 3.2 | X |
| 4 | X |
| 4.8 | X |
| 6 | X |

Remaches estándar Ø 6 sólo en aluminio.

REMACHADORA OLENEUMATICA REMACHES

MODELO RR171 – REFERENCIA 7000RR171 – CODIGO 30006

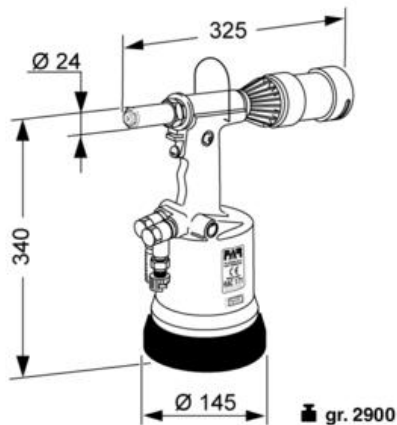

**REMACHADORA OLENEUMATICA CON RETENCION DEL REMACHE Y RECUPERACION DEL VASTAGO,
PARA REMACHES DE TODAS LA ALEACIONES \varnothing 4.8 ---- 7.8 (SOLO ALUMINIO/ACERO)
PUEDE REMACHAR REMACHE ESTRUCTURAL**

| DIAMETRO | REM.STANDARD |
|----------|--------------|
| 4.8 | X |
| 6 | X |
| 6.4 | X |
| 7.8 | X |

REMACHADORA BATERIA REMACHES

MODELO RR311 – REFERENCIA 7000RR310 – CODIGO 30007

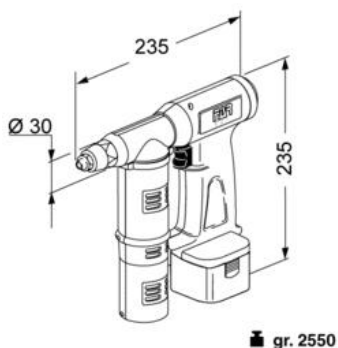

PRESENTACION EN MALETA

Remaches estándar Ø 6 sólo en aluminio.

Remachadora de batería profesional por la colocación de remaches de Ø 2,4 hasta Ø 4,8 en todas aleaciones y de Ø 6mm de aluminio.

La remachadora, se suministra en un maletín de plástico resistente completo con dos baterías de 12 voltios y un cargador-3 Ah.

| DIAMETRO | REM.STANDARD |
|----------|--------------|
| 2.4 | X |
| 3 | X |
| 3.2 | X |
| 4 | X |
| 4.8 | X |
| 6 | X |

REMACHADORAS PARA TUERCAS MANUALES Y OLENEUMATICAS



REMACHADORA MANUAL TUERCAS REMACHABLES

MODELO RT17 – REFERENCIA 7100RT17 – CODIGO 30029

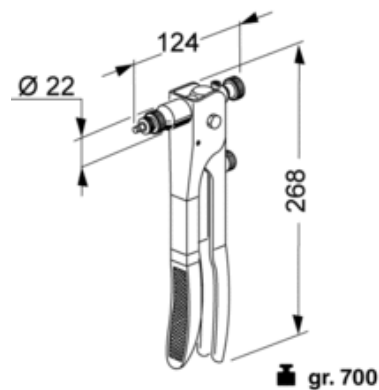

PRESENTACION:

MALETA CON TIRANTES Y TUERCAS

CAJA DE CARTON

| METRICA | ALUMINIO | ACERO | INOX |
|---------|----------|-------|------|
| M3 | X | X | X |
| M4 | X | X | X |
| M5 | X | X | X |
| M6 | X | X | |

REMACHADORA MANUAL TUERCAS REMACHABLES

MODELO RT21 – REFERENCIA 7100RT21 – CODIGO 30024

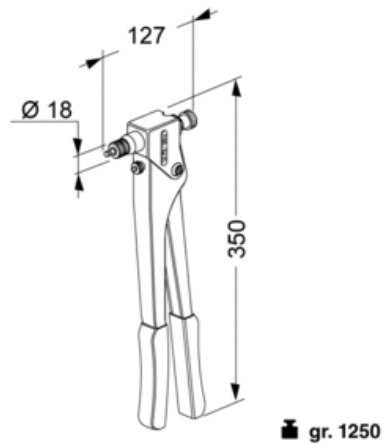

PRESENTACION:

MALETA CON TIRANTES Y TUERCAS

| METRICA | ALUMINIO | ACERO | INOX |
|---------|----------|-------|------|
| M3 | X | X | X |
| M4 | X | X | X |
| M5 | X | X | X |
| M6 | X | X | X |
| M8 | X | X | |

REMACHADORA MANUAL TUERCAS REMACHABLES

MODELO RT28 – REFERENCIA 7100RT28 – CODIGO 30025

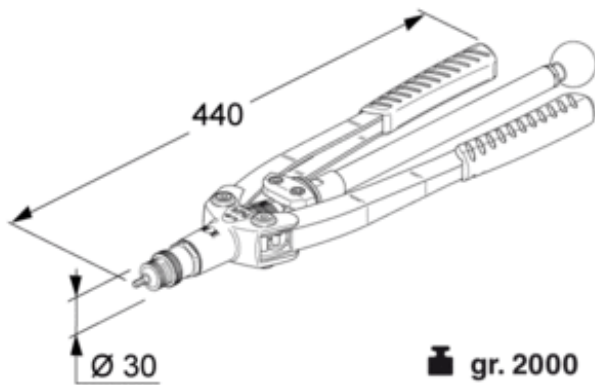

| METRICA | ALUMINIO | ACERO | INOX |
|---------|----------|-------|------|
| M3 | X | X | X |
| M4 | X | X | X |
| M5 | X | X | X |
| M6 | X | X | X |
| M8 | X | X | X |
| M10 | X | X | X |

REMACHADORA OLENEUMATICA PARA TUERCAS REMACHABLES

MODELO RT60 – REFERENCIA 7100RT60 – CODIGO 30026

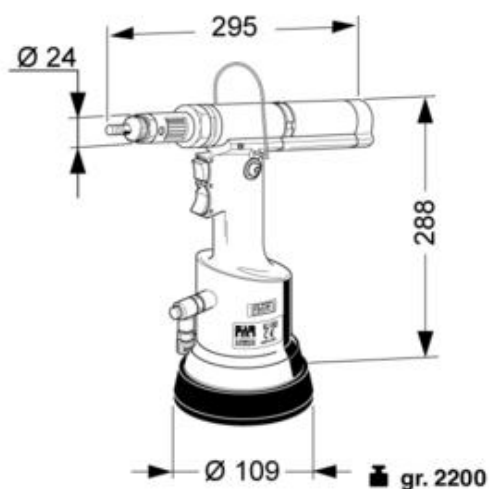

PRESENTACION:

MALETA CON TIRANTES Y TUERCAS

| METRICA | ALUMINIO | ACERO | INOX |
|---------|----------|-------|------|
| M3 | X | X | X |
| M4 | X | X | X |
| M5 | X | X | X |
| M6 | X | X | X |
| M8 | X | X | X |



REMACHADORA OLENEUMATICA PARA TUERCAS REMACHABLES

MODELO RT45 – REFERENCIA 7100RT45 – CODIGO 3002

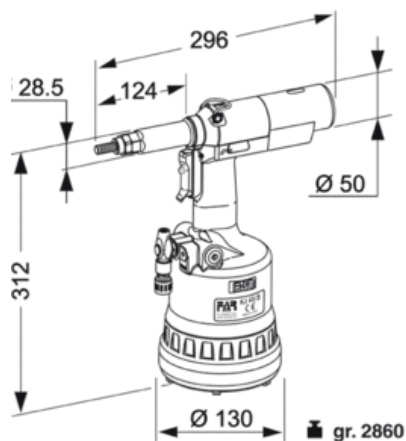

PRESENTACION:

MALETA CON TIRANTES Y TUERCAS

| METRICA | ALUMINIO | ACERO | INOX |
|---------|----------|-------|------|
| M3 | X | X | X |
| M4 | X | X | X |
| M5 | X | X | X |
| M6 | X | X | X |
| M8 | X | X | X |
| M10 | X | X | X |
| M12 | X | X | X |



REMACHES CYA, S.L

Ctra. Madrid km6 31591 Corella (Navarra)

www.remachescya.com

FABRICANTES DESDE 1971

Teléf.: 948.780.420

Fax: 948.780.203

remaches@remachescya.com

NOTAS:





FABRICANTES DESDE 1.971

REMACHES CYA, SL

CTRA. MADRID KM.6 - 31.591 CORELLA (NAVARRA)

APARTADO DE CORREOS Nº 25

TELEFONOS: 948.780.420/948.780.976/948.401.220

FAX: 948.780.203

Web: www.remachescya.com

MOVIL: 665 68 55 47



E-mail: remaches@remachescya.com

REDES SOCIALES:

