



CATÁLOGO GENERAL

GENERAL CATALOGUE
CATALOGUE GÉNÉRAL

V.7

Future needs tools



Certificación
Concedida a

INDUSTRIAS TAYG SLU

AVENIDA REAL DE MADRID NORTE, 70 - 46469 - BENIPARRELL - VALENCIA - ESPAÑA

Bureau Veritas Certification certifica que el Sistema de Gestión ha sido auditado y encontrado conforme con los requisitos de la norma:

NORMA

ISO 9001:2015

El Sistema de Gestión se aplica a:

DISEÑO Y FABRICACIÓN DE ARTÍCULOS DE PLÁSTICO PARA BRICOLAJE, FERRETERÍA Y ALIMENTACIÓN. COMERCIALIZACIÓN DE ARTÍCULOS PARA BRICOLAJE, FERRETERÍA Y ALIMENTACIÓN.

Número del certificado: ES121878-1
Aprobación original: 10-07-2009
Certificado en vigor: 09-07-2021
Caducidad del certificado: 08-07-2024

Este certificado está sujeto a los términos y condiciones generales y particulares de los servicios de certificación.

Bureau Veritas Barro S.L.
C/Valpente Primera 25-Da, Saffica Cava, 28108 Alcobendas - Madrid, España
91.855.6200

Certification
Awarded to

INDUSTRIAS TAYG SLU

AVENIDA REAL DE MADRID NORTE, 70 - 46469 - BENIPARRELL - VALENCIA - ESPAÑA

Bureau Veritas Certification certifies that the Management System has been audited and found to be in accordance with the requirements of standard:

STANDARD

ISO 9001:2015

Scope of certification:

DESIGN AND PRODUCTION OF PLASTIC ARTICLES FOR HARDWARE, D.I.Y. AND FOOD. COMMERCIALIZATION OF PRODUCTS FOR HARDWARE, D.I.Y. AND FOOD.

Certificate Number: ES121878-1
Original approval date: 10-07-2009
Effective date: 09-07-2021
Certificate expiration date: 08-07-2024

This certificate is valid subject to the general and specific terms and conditions of certification services.

Bureau Veritas Barro S.L.
C/Valpente Primera 25-Da, Saffica Cava, 28108 Alcobendas - Madrid, España
91.855.6200

Certificación
Concedida a

INDUSTRIAS TAYG SLU

AVENIDA REAL DE MADRID NORTE, 70 - 46469 - BENIPARRELL - VALENCIA - ESPAÑA

Bureau Veritas Certification certifica que el Sistema de Gestión ha sido auditado y encontrado conforme con los requisitos de la norma:

NORMA

ISO 14001:2015

El Sistema de Gestión se aplica a:

DISEÑO Y FABRICACIÓN DE ARTÍCULOS DE PLÁSTICO PARA BRICOLAJE, FERRETERÍA Y ALIMENTACIÓN. COMERCIALIZACIÓN DE ARTÍCULOS PARA BRICOLAJE, FERRETERÍA Y ALIMENTACIÓN.

Número del certificado: ES121877-1
Aprobación original: 09-07-2018
Certificado en vigor: 09-07-2021
Caducidad del certificado: 08-07-2024

Este certificado está sujeto a los términos y condiciones generales y particulares de los servicios de certificación.

Bureau Veritas Barro S.L.
C/Valpente Primera 25-Da, Saffica Cava, 28108 Alcobendas - Madrid, España
91.855.6200

Certification
Awarded to

INDUSTRIAS TAYG SLU

AVENIDA REAL DE MADRID NORTE, 70 - 46469 - BENIPARRELL - VALENCIA - ESPAÑA

Bureau Veritas Certification certifies that the Management System has been audited and found to be in accordance with the requirements of standard:

STANDARD

ISO 14001:2015

Scope of certification:

DESIGN AND PRODUCTION OF PLASTIC ARTICLES FOR HARDWARE, D.I.Y. AND FOOD. COMMERCIALIZATION OF PRODUCTS FOR HARDWARE, D.I.Y. AND FOOD.

Certificate Number: ES121877-1
Original approval date: 09-07-2018
Effective date: 09-07-2021
Certificate expiration date: 08-07-2024

This certificate is valid subject to the general and specific terms and conditions of certification services.

Bureau Veritas Barro S.L.
C/Valpente Primera 25-Da, Saffica Cava, 28108 Alcobendas - Madrid, España
91.855.6200

Certification
Attribuée à

INDUSTRIAS TAYG SLU

AVENIDA REAL DE MADRID NORTE, 70 - 46469 - BENIPARRELL - VALENCIA - ESPAÑA

Bureau Veritas certifie que le système de management a été évalué et jugé conforme aux exigences de la norme:

NORME:

ISO 9001:2015

Domaine d'activité du Système de Management:

PRODUCTION ET DESIGN D'ARTICLES EN PLASTIQUE POUR L'INDUSTRIE, LE BRICOLAGE ET L'ALIMENTAIRE. COMMERCIALISATION D'ARTICLES POUR L'INDUSTRIE, LE BRICOLAGE ET L'ALIMENTAIRE.

Numéro du certificat: ES121878-1
Approbation originale: 10-07-2009
Certificat en vigueur: 09-07-2021
Validité du certificat: 08-07-2024

Ce certificat est soumis aux termes et aux conditions générales et particulières des services de certification.

Bureau Veritas Barro S.L.
C/Valpente Primera 25-Da, Saffica Cava, 28108 Alcobendas - Madrid, España
91.855.6200

Zertifikat
Für

INDUSTRIAS TAYG SLU

AVENIDA REAL DE MADRID NORTE, 70 - 46469 - BENIPARRELL - VALENCIA - ESPAÑA

Bureau Veritas Certification bestätigt, dass das Management-System der oben genannten Organisation beurteilt wurde und die in den folgenden Normen und Regelwerken festgelegten Anforderungen erfüllt:

NORMEN

ISO 9001:2015

Anwendungsbereich:

DESIGN UND HERSTELLUNG VON KUNSTSTOFFARTIKELN FÜR EISENWAREN, HEIMWERKEN UND LEBENSMITTEL. VERMARKTUNG VON ARTIKELN FÜR EISENWAREN, HEIMWERKEN UND LEBENSMITTEL.

Zertifikat Nummer: ES121878-1
Datum der Erstzertifizierung: 10-07-2009
Gültig ab: 09-07-2021
Ablaufdatum des Zertifikats: 08-07-2024

Dieses Zertifikat ist gültig vorbehaltlich der allgemeinen und spezifischer Bedingungen von Zertifizierungsdiensten.

Bureau Veritas Barro S.L.
C/Valpente Primera 25-Da, Saffica Cava, 28108 Alcobendas - Madrid, España
91.855.6200

Certification
Attribuée à

INDUSTRIAS TAYG SLU

AVENIDA REAL DE MADRID NORTE, 70 - 46469 - BENIPARRELL - VALENCIA - ESPAÑA

Bureau Veritas certifie que le système de management a été évalué et jugé conforme aux exigences de la norme:

NORME

ISO 14001:2015

Domaine d'activité du Système de Management:

PRODUCTION ET DESIGN D'ARTICLES EN PLASTIQUE POUR L'INDUSTRIE, LE BRICOLAGE ET L'ALIMENTAIRE. COMMERCIALISATION D'ARTICLES POUR L'INDUSTRIE, LE BRICOLAGE ET L'ALIMENTAIRE.

Numéro du certificat: ES121877-1
Approbation originale: 09-07-2018
Certificat en vigueur: 09-07-2021
Validité du certificat: 08-07-2024

Ce certificat est soumis aux termes et aux conditions générales et particulières des services de certification.

Bureau Veritas Barro S.L.
C/Valpente Primera 25-Da, Saffica Cava, 28108 Alcobendas - Madrid, España
91.855.6200

Zertifikat
Für

INDUSTRIAS TAYG SLU

AVENIDA REAL DE MADRID NORTE, 70 - 46469 - BENIPARRELL - VALENCIA - ESPAÑA

Bureau Veritas Certification bestätigt, dass das Management-System der oben genannten Organisation beurteilt wurde und die in den folgenden Normen und Regelwerken festgelegten Anforderungen erfüllt:

NORMEN

ISO 14001:2015

Anwendungsbereich:

DESIGN UND HERSTELLUNG VON KUNSTSTOFFARTIKELN FÜR EISENWAREN, HEIMWERKEN UND LEBENSMITTEL. VERMARKTUNG VON ARTIKELN FÜR EISENWAREN, HEIMWERKEN UND LEBENSMITTEL.

Zertifikat Nummer: ES121877-1
Datum der Erstzertifizierung: 09-07-2018
Gültig ab: 09-07-2021
Ablaufdatum des Zertifikats: 08-07-2024

Dieses Zertifikat ist gültig vorbehaltlich der allgemeinen und spezifischer Bedingungen von Zertifizierungsdiensten.

Bureau Veritas Barro S.L.
C/Valpente Primera 25-Da, Saffica Cava, 28108 Alcobendas - Madrid, España
91.855.6200

SOBRE NOSOTROS

About us / A propos de nous / Wir über uns



Future needs tools

Desde hace más de 50 años, apostamos por la calidad con el producto, el servicio y el medio ambiente. Donde el diseño y la innovación han sido piezas clave de nuestro continuo crecimiento, sin olvidar la importancia de la relación entre la máxima calidad y el mejor servicio. Nuestra compañía tiene dimensión y gran potencial operativo, con una capacidad de transformación de más de 7.000 Tn al año. Impulsados hacia una visión global cada vez mayor, una red de agentes se distribuyen por todo el mundo, estando presentes en más de 40 países de todo el mundo.

Siempre orientados al producto para el profesional, el DIY y relacionado con la construcción, el trabajo profesional y el mundo del bricolaje.

We have been working for over 50 years to bring innovation into our product range. Where Design and innovation have always been key elements of our continual growth, while preserving the best quality and service.

Our company has capacity and great operative potential, with a transformation capacity of more than 7,000 tonnes per year.

Driven towards a growing international vision, a network of agents are distributed throughout the world, being present in more than 40 countries.

Always focused to the product for the professional, the DIY and related with construction, professional work and the world of DIY.

Depuis plus de 50 ans, on a parié pour la qualité du produit, le service et l'environement. Ou le design et l'innovation ont été des pièces clé de croissance continue, sans oublier l'importance de la relation entre la qualité maximale et le meilleur service .

Notre société est bien structurée et a un grand potentiel opératif, avec une capacité de transformation de plus de 7000 tones de polymère a l'année. Impulsée vers une vision globale toujours majeure, un réseau d'agents distribué dans le monde entier, étant présents dans plus de 40 pays.

Toujours orientés aux produits pour professionnels, la grande distribution de bricolage et en relation avec la construction.

Seit mehr als 50 Jahren setzen wir auf Innovation unserer Erzeugnisse. Design und Innovation waren immer entscheidend für unser kontinuierliches Wachstum unter Einhaltung bester Qualität und Serviceleistungen. Unser Unternehmen besitzt hohe Kapazitäten und ein starkes, operatives Potential und eine Verarbeitungskapazität von mehr als 7.000 Tonnen im Jahr.

Im Sinne einer immer größeren, internationalen Vision besitzen wir weltweit ein Netzwerk von Vertretern und sind so in mehr als 40 Ländern präsent.

Immer auf das Produkt für den Profi, den Heimwerker und verwandte ausgerichtet mit Bau, professioneller Arbeit und der Welt des DIY.

GUÍA

Guide / Guide / Leitfaden



MATERIALES

Materials / Matériaux / Materialien



Polipropileno / Polypropylene / Polypropylène / Polypropylen
Termoplástico tipo commodity (standard). Polímeros cristalizados aleatoriamente. Transparente.
A commodity (standard) thermoplastic. Randomly crystallised polymers. Transparent.
Produit de type thermoplastique (standard). Les polymères ont cristallisé au hasard. Transparent.
Thermoplast für Bedarfsartikel (Standard). Zufällig kristallisierte Polymere. Durchsichtig.



Poliestireno / Polystyrene / Poliestirène / Polystyrol
Termoplástico tipo commodity (standard). Polimerización del estireno.
A commodity (standard) thermoplastic. Polymerisation of styrene.
Produit de matériau thermoplastique (standard). Polymérisation du styrène.
Thermoplast für Bedarfsartikel (Standard). Polymerisierung des Styrols.



Policarbonato / Polycarbonate / Polycarbonate / Polycarbonat
Termoplástico de altas prestaciones (no es commodity). Alto impacto. Transparente.
High-pressure thermoplastic (non-commodity). High-impact. Transparent.
Thermoplastique de hautes prestations (n'est pas commodity). Haut impacte. Transparent.
Hoch leistungsfähiges Thermoplast (nicht für Bedarfsartikel). Sehr schlagzähe. Durchsichtig.



Polipropileno / Polypropylene / Polypropylène / Polypropylen
Termoplástico tipo commodity (standard). Copolímeros opacos (polimerización de propileno con etileno o con butadieno).
A commodity (standard) thermoplastic. Opaque copolymers (polymerization of propylene with ethylene or butadiene).
Produit de type thermoplastique (standard). Polymères opaques (polymerisation du propylène et de l'éthylène ou avec du butadiène).
Thermoplast für Bedarfsartikel (Standard). Matte Mischpolymere (Polymerisierung von Propylen mit Ethylen oder Butadien).



Poliétileno / Polyethylene / Polyéthylène / Polyethylen
Termoplástico tipo commodity (standard). Polimerización del etileno. Alta densidad, buena resistencia a los ataques químicos.
A commodity (standard) thermoplastic. Polymerisation of ethylene. High-density, good resistance to chemical attacks.
Produit de type thermoplastique (standard). Polymérisation de l'éthylène. Haute densité, bonne résistance aux attaques chimiques.
Thermoplast für Bedarfsartikel (Standard). Polymerisierung des Ethylens. Hohe Dichte, hohe Beständigkeit gegen chemische Einwirkung.



Poliéster / Polyester / Polyester / Polyester
Elastómero fibra sintética. Se clasifica en Denier (D) Mayor Denier, mayor espesor y mayor resistencia mecánica 300D - 600D - 900D.
Synthetic elastomer fibre. Classified in Denier (D) Greater Denier, thicker and greater mechanical resistance 300D - 600D - 900D.
Fibre synthétique élastomère. Il est classé dans Denier (D) Denier, épaisseur supérieure et résistance mécanique supérieure 300D - 600D - 900D.
Elastomer Kunstfaser. Wird nach Denier (D) klassifiziert. Je höher der Denier-Wert, desto größere Schichtdicke und höhere mechanische Festigkeit 300D - 600D - 900D.



Poliestireno / Polystyrene / Polystyrène / Polystyrol
Termoplástico tipo commodity (standard). Polimerización del estireno. Transparente.
A commodity (standard) thermoplastic. Polymerisation of styrene. Transparent.
Produit de type thermoplastique (standard). Polymérisation du styrène. Transparent.
Thermoplast für Bedarfsartikel (Standard). Polymerisierung des Styrols. Durchsichtig.



Poliétileno / Polyethylene / Polyéthylène / Polyethylen
Termoplástico tipo commodity (standard). Polimerización del etileno.
A commodity (standard) thermoplastic. Polymerisation of ethylene.
Produit de type thermoplastique (standard). Polymérisation de l'éthylène.
Thermoplast für Bedarfsartikel (Standard). Polymerisierung des Ethylens.



Poliestireno / Polystyrene / Poliestirène / Polystyrol
Termoplástico tipo commodity (standard). Polimerización del estireno. PS de alto impacto.
A commodity (standard) thermoplastic. Polymerisation of styrene. High-Impact PS.
Produit de type thermoplastique (standard). Polymérisation du styrène. PS à fort impact.
Thermoplast für Bedarfsartikel (Standard). Polymerisierung des Styrols. Sehr schlagzähes PS.



Poliuretano / Polyurethane / Poliuretane / Polyurethan
Material esponjas caja herramientas.
Spongy material toolboxes.
Materiel mousse boites a outils.
Material für die Schwämme der Werkzeugkästen



Cuero natural / Natural leather / Cuir naturel / Leder



CARACTERÍSTICAS

Features / Caractéristiques



Medidas en las tablas
Measurements in tables
Tableau de mesures
Largo (L) x ancho (W) x alto (H)



Soporta 120kg
Supports up to 120kg
Supporte 120kg



Personalizable
Customizable
Personnalisable



Asa de Seguridad Antiapertura
Anti Opening Lock System
Poignée de sécurité anti ouverture



Ligero
Lightweight
Léger



Impermeable
Waterproof
Imperméable



Protección contra rayos UVA
Protection against UV rays
Protection contre les rayons uva



Grandes formatos
Big sizes
Gran formats



Colores especiales disponibles en todos los colores RAL bajo pedido. Consultar
Special colours available in all RAL colours under request. Please send us your enquiry.
Couleurs spéciales disponibles dans toute gamme de coloris RAL, sur demande.



Apto para uso alimentario
Food graded
Apte pour l'utilisation alimentaire



Eficiencia logística
Logistic efficiency
Efficacité logistique



Tecnología de RFID
RFID technology
Technologie RFID



Tamaño 33L
Size 33L
Mesures 33L



Resistente
Resistant
Resistant



Soporta 40kg por estante
Up to 40 kg per shelf
Jusqu'à 40 kg par étagère



Montaje en 10 minutos
Assembly in 10 minutes
Assemblée en 10 minutes



No se necesitan herramientas para su montaje
No tools are needed for assembly
Aucun outil n'est nécessaire pour l'assemblage



Alta resistencia
High strength
Haute resistance



Protección para niños
Protection for children
Protection pour enfants



Homologados para transporte de mercancías peligrosas clases 3, 6.1, 8 y 9
Approved for transporting Class 3, 6.1, 8, 9 dangerous goods
Homologation pour le transport de marchandises dangereuses classées 3, 6.1, 8, 9



Uso industrial
Industrial use
Usage industriel



Personalizable con tecnología IML
Customizable with IML technology
Personnalisable avec la technologie IML

Tayg, en la vanguardia de la innovación, también se ha adaptado a la producción del siglo XXI con materiales que ponen en valor las normativas de reciclaje a nivel mundial. Lo ha hecho a través de la fabricación de productos que permiten un uso racional de los materiales de desecho y, a su vez, un rápido reciclaje.

Además, fieles a dicho compromiso por la sostenibilidad y el medio ambiente, también utiliza materiales reciclados — tanto, que cuenta con una planta propia para reciclar materia prima—, hace un consumo eficiente de la energía, realiza tratamiento de residuos, y controla las emisiones atmosféricas. Actualmente es una de las únicas plantas de inyección de plástico en Europa con la ISO 14001 de cuidado del medio ambiente. Tayg.

Future needs tools

Always at the forefront of innovation, Tayg has also adapted to 21st century production with materials that place value on global regulations on recycling. This has been made possible through the manufacturing of products that allow for the rational use of waste materials and, in turn, rapid recycling.

In addition, in line with that commitment to sustainability and the environment, the company also uses recycled materials —in fact, it has its own plant for recycling raw materials— makes efficient use of energy, treats waste, and controls atmospheric emissions. Currently is one of the unique plastic injection manufacturer in Europe with ISO14001 in care of the environment. Tayg

Future needs tools

Tayg est à l'avant-garde dans l'innovation. Nous adaptions nos procédés de fabrication des articles de bricolage et de quincaillerie à la production du XXIe s. avec des matériaux qui mettent en valeur les réglementations en matière de recyclage à l'échelle mondiale. Nous y parvenons au travers de la fabrication de produits qui permettent un usage rationnel des matériaux de recyclage et, à la fois, un recyclage rapide.

En outre, fidèles à cet engagement pour la durabilité et l'environnement, nous utilisons également des matériaux recyclés - au point de disposer de notre propre usine de recyclage de matières premières, nous faisons une consommation efficace de l'énergie, nous faisons le traitement des déchets et nous contrôlons les émissions atmosphériques. Tayg

Future needs tools

Tayg stellt die Avantgarde der Innovation dar und hat sich auch durch die Verwendung von Materialien, welche weltweit die Recyclingregelungen erfüllen, an die Produktion des 21. Jahrhunderts angepasst. Dies wird durch die Fertigung von Erzeugnissen ermöglicht, die eine zweckmäßige Nutzung der Abfallmaterialien und gleichzeitig ein rasches Recycling erlaubt.

Außerdem verwendet das Unternehmen im Sinne seines Engagements für Nachhaltigkeit und Umweltschutz auch Recyclingmaterial - und verfügt dafür über eine eigene Anlage zum Recycling von Rohstoffen, nutzt Energie effizient, behandelt seine Abfälle und kontrolliert die Luftemissionen. Es ist derzeit eine der wenigen Werke von Kunststoffspritzguss in Europa mit Umweltschutz nach ISO 14001. Tayg

Future needs tools

pág. 10



CAJA DE HERRAMIENTAS Y ESTUCHES

Tool boxes and organizers
Boîtes à outils et coffrets
Werkzeugkoffer und
Kleinteileaufbewahrung

pág. 48



PRODUCTOS DE ORDENACIÓN

Arrangement products
Produits de rangement
Produkten für Aufbewahrung

pág. 74



TAYG CAR

Tayg Car
Tayg Car
Tayg Car

pág. 78



PRODUCTOS DE ORDENACIÓN

Arrangement products
Produits de rangement
Produkten für Aufbewahrung

pág. 82



ECO TAYG

Eco Tayg
Eco Tayg
Eco Tayg

pág. 94

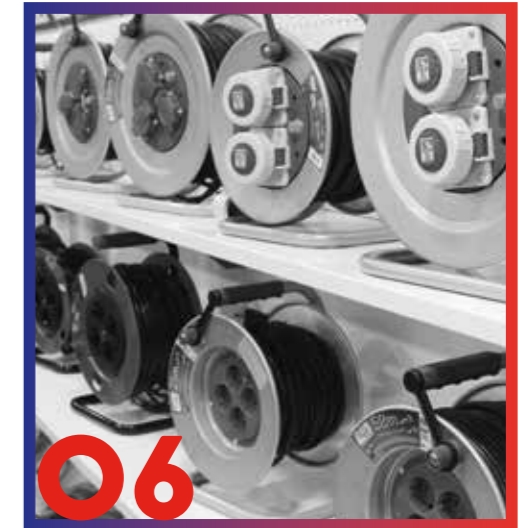

ACCESORIOS ELÉCTRICOS

Electrical accessories
Accessoires électriques
Elektrozubehör

pág. 116

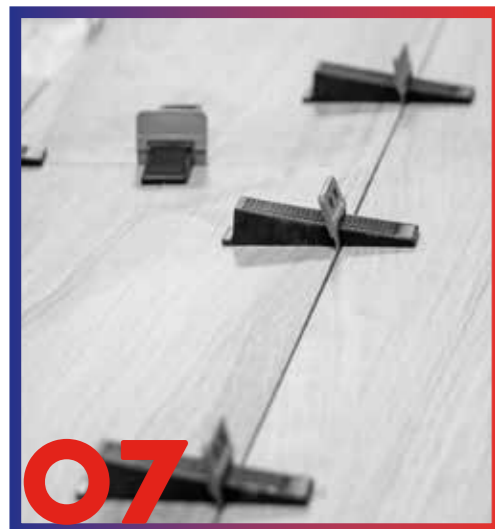

ACCESORIOS PARA LA CONSTRUCCIÓN

Building accessories
Accessoires pour la
construction
Bauzubehör

pág. 154



LISTA DE PACKING

Packing list
Liste d'emballage
Verpackungsliste



ÍNDICE

INDEX / INDEX / INHALTSVERZEICHNIS

CAJAS DE HERRAMIENTAS Y ESTUCHES

Tool boxes and organizers | Boîtes à outils et coffrets
Werkzeugkoffer und Kleinteileaufbewahrung

01



ESTUCHES CON SEPARADORES FIJOS **12**

Organizers with fixed distribution
Coffret à casiers fixes
Organizers mit fester Facheinteilug



ESTUCHES CON SEPARADORES MÓVILES **14**

Organizers with mobile dividers
Coffret à séparateurs
Kleinteilerkoffer mit flexibler Facheinteilug



ESTUCHES CON CAJONES EXTRAÍBLES | CAJONES EXTRAÍBLES DE 50 Y 80 **16**

Organizers with mobile drawers |
Removable drawers 50 and 80
Coffret à compartiments amovibles |
Compartiments amovibles de 50 et 80
Organizers mit herausnehmbaren Einsätze |
Herausnehmbaren Fächern von 50 und 80



MALETAS HERRAMIENTAS ELÉCTRICAS **18**

Plastic tool boxes
Mallettes pour outillage électrique
Elektrowerkzeuge koffer



CAJAS DE HERRAMIENTA DE PLÁSTICO **22**

Plastic tool boxes
Boîtes à outils plastiques
Werkzeugkoffer aus Kunststoff



CAJA METÁLICA | CAJA DE PLÁSTICO **24**

Metallic box | Plastic box
Boîte en métal | Boîte en plastique
Metallgehäuse | Werkzeugkoffer aus
Metall und Kunststoff



CAJAS DE HERRAMIENTAS DE PLÁSTICO - ALUMINIO **26**

Plastic - aluminium tool boxes
Boîtes à outils plastiques et aluminium
Werkzeugkoffer aus Kunststoff und
Aluminium



CAJAS DE HERRAMIENTAS DE PLÁSTICO - ALUMINIO | COFRE HERRAMIENTAS MOVIL **30**

Plastic - aluminium tool boxes |
Mobile tool chest
Boîtes à outils plastiques et aluminium |
Coffre a outils mobile
Werkzeugkoffer aus Kunststoff und
Aluminium | Mobile Werkzeugbox



TRAIL BOX / SAFETY TOOL BOX **32**

Trail box - Safety tool box
Servanter de chantier - Safety tool box
Trail-Box - Safety tool box



TRAIL BOX PRO **36**

Trail box pro
Servanter de chantier pro
Trail-Box pro



CAJA DE HERRAMIENTAS COLECCIÓN BÁSICA **38**

Basic line tool boxes
Boîtes à outils Basic Line
Werkzeugkoffer Basic-Kollektion



BOLSAS HERRAMIENTAS | CINTURÓN HERRAMIENTAS **42**

Tool bags | Tool belt
Sacs à outils | Ceintures outils
Werkzeugtaschen | Werkzeuggürtel



MOCHILA HERRAMIENTAS **44**

Backpack
Sacs à dos à outils
Werkzeugrucksack



CINTURONES Y SOPORTES DE CUERO **46**

Leather belts and holders
Ceintures et supports à cuir
Gestell und Ledergürtel



ESTUCHES CON SEPARADORES FIJOS

Organizers with fixed distribution / Coffret à casiers fixes

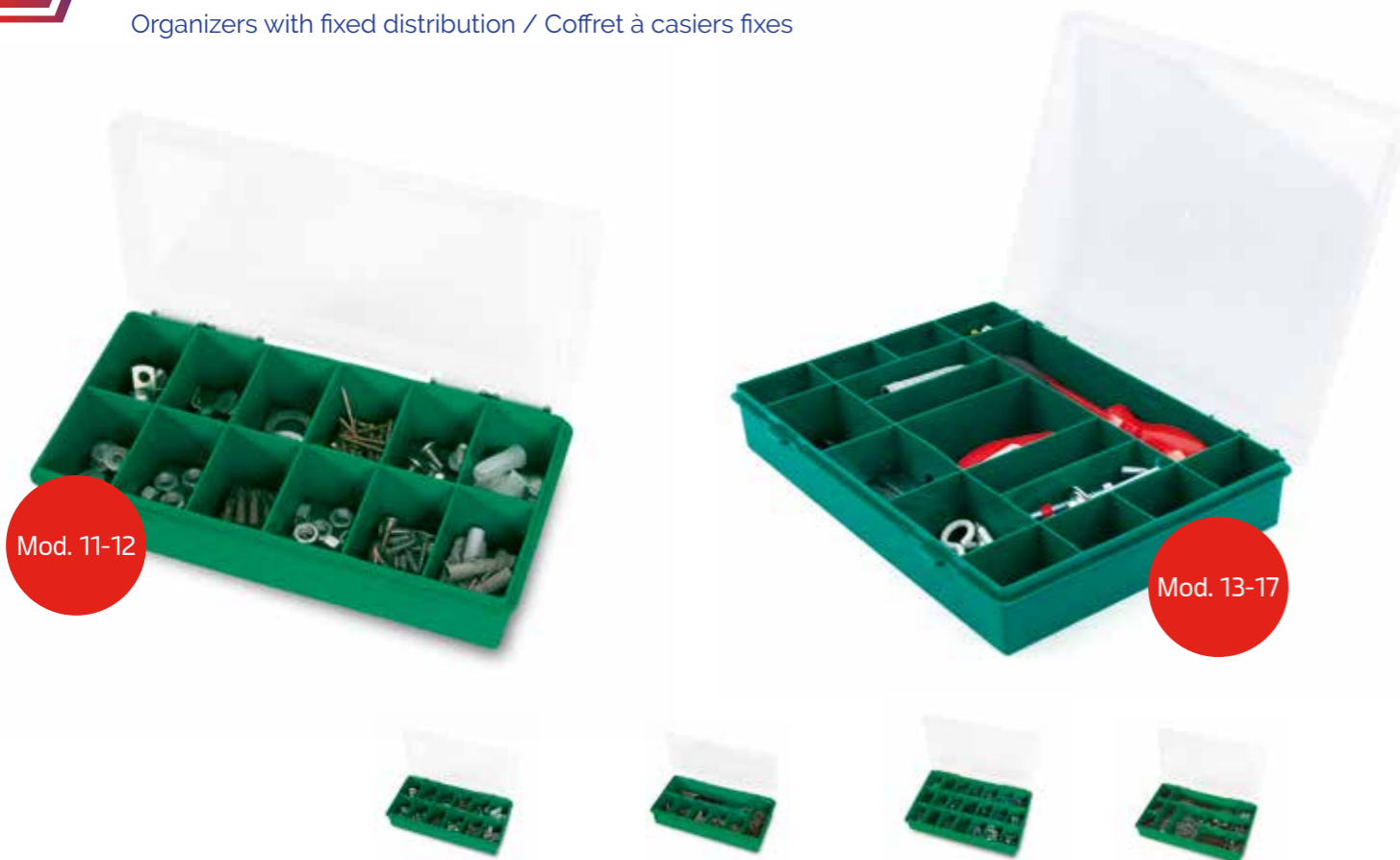

MODELO Model / Modèle	11-12	11-7	12-21	12-11
CÓDIGO Code / Code	050107	051104	060106	061103
MEDIDAS Sizes / Mesures	250 x 140 x 54 mm	250 x 140 x 54 mm	290 x 195 x 54 mm	290 x 195 x 54 mm
MATERIAL Material / Matériau	PP	PP	PP	PP
EMBALAJE / UNIDADES Packing / Units Emballage / Unités	6	6	6	6



MODELO Model / Modèle	33-15	33-9	13-32	13-17
CÓDIGO Code / Code	008009	009006	070105	071102
MEDIDAS Sizes / Mesures	215 x 207 x 42 mm	215 x 207 x 42 mm	330 x 247 x 54 mm	330 x 247 x 54 mm
MATERIAL Material / Matériau	PP	PP	PP	PP
EMBALAJE / UNIDADES Packing / Units Emballage / Unités	12	12	6	6

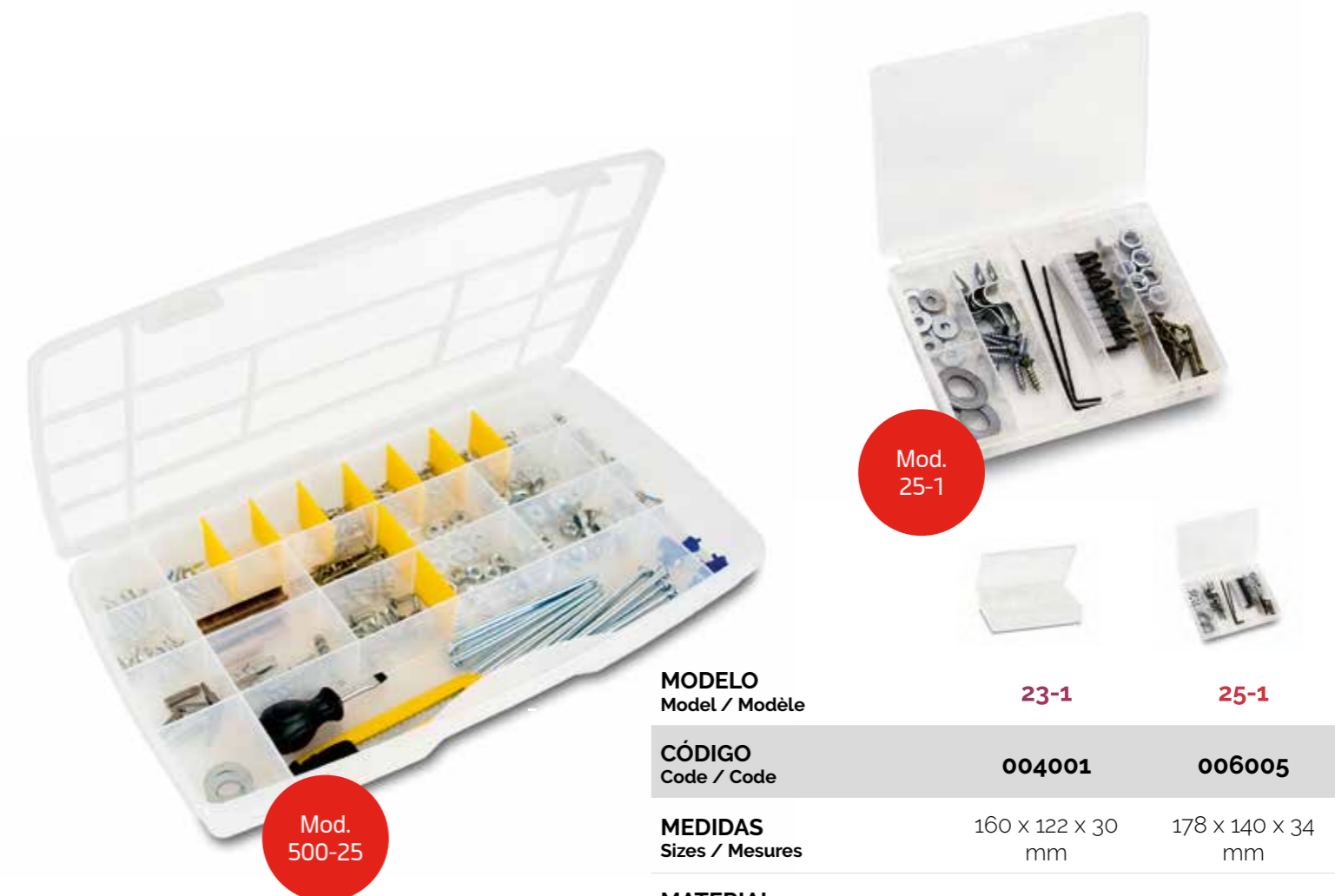

MODELO Model / Modèle	23-1	25-1
CÓDIGO Code / Code	004001	006005
MEDIDAS Sizes / Mesures	160 x 122 x 30 mm	178 x 140 x 34 mm
MATERIAL Material / Matériau	PP	PP
EMBALAJE / UNIDADES Packing / Units Emballage / Unités	24	24



MODELO Model / Modèle	170-7	240-12	300-16	450-25	500-25
CÓDIGO Code / Code	012006	013003	014000	010002	011009
MEDIDAS Sizes / Mesures	170 x 114 x 36 mm	240 x 155 x 41 mm	300 x 199 x 46 mm	387 x 230 x 49 mm	440 x 244 x 49 mm
CONTIENE Contained / Contient	Eurohole With eurohole Avec eurohole	Eurohole With eurohole Avec eurohole	—	8 Separadores Dividers / Séparateurs	8 Separadores Dividers / Séparateurs
MATERIAL Material / Matériau	PP	PP	PP	PP	PP
EMBALAJE / UNIDADES Packing / Units Emballage / Unités	12	12	6	6	6



ESTUCHES CON SEPARADORES MÓVILES

Organizers with mobile dividers / Coffret à séparateurs



Mod. 47-26

Doble cierre
Double closure
Double fermeture

Colores. Tapa transparente, separadores amarillos y base azul
Colours. Clear lid, yellow dividers and blue base.
Couleurs. Couvercle transparent, séparateurs jaunes et base bleue

Medidas. 460mm (L) x 350mm (A) x 81mm (H)
Dimensions. 460mm x 350mm x 81mm
Dimensions. 460mm x 350mm x 81mm

21 separadores móviles. Compartimentos diseñados para que no se mezclen.
Organiser case with 21 movable dividers.
Casier à séparateurs amovibles, avec 21 séparateurs



Mod. 47-26



MODELO Model / Modèle	45-26	46-26	47-26	48-26	49-16
CÓDIGO Code / Code	145001	146008	147005	148002	049002
MEDIDAS LxAxH Sizes / Mesures	312 x 238 x 51 mm	378 x 290 x 61 mm	460 x 350 x 81 mm	460 x 350 x 81 mm	490 x 250 x 80 mm
CONTIENE Contained / Contient	21 Separadores Dividers/ Séparateurs	21 Separadores Dividers/ Séparateurs	21 Separadores Dividers/ Séparateurs	21 Separadores Dividers / Séparateurs	12 Separadores Dividers/ Séparateurs
MATERIAL Material / Matériau	PP	PP	PP	Base, separadores y cierres: PP. Base, dividers and locks: PP. Base, Séparateurs et attaches: PP.	PP
EMBALAJE / UNIDADES Packing / Units Emballage / Unités	6	6	5	5	5

Base, separadores y cierres: PP.
Base, dividers and locks: PP.
Base, Séparateurs
et attaches: PP.
Tapa/Cover/Couvercle:
POLICARBONATO (PC)



MODELO Model / Modèle	20-9	21-10	22-26	23-26	24-26
CÓDIGO Code / Code	020001	021008	022005	023002	024009
MEDIDAS LxAxH Sizes / Mesures	190 x 150 x 42 mm	256 x 192 x 42 mm	312 x 238 x 51 mm	388 x 290 x 61 mm	460 x 350 x 81 mm
CONTIENE Contained / Contient	—	—	21 Separadores Dividers / Séparateurs	21 Separadores Dividers / Séparateurs	21 Separadores Dividers / Séparateurs
MATERIAL Material / Matériau	PP	PP	PP	PP	PP
EMBALAJE / UNIDADES Packing / Units Emballage / Unités	12	12	6	6	5



ESTUCHES CON CAJONES EXTRAÍBLES

Organizers with mobile drawers / Coffret à compartiments amovibles

ESTUCHES CON CAJONES EXTRAÍBLES 50

Organizers with removable drawers 50

Coffret à compartiments amovibles 50



MODELO Model / Modèle	430/50/50	430/50/25	430/50/0
CÓDIGO Code / Code	030000	031007	030406
MEDIDAS Sizes / Mesures	430 x 370 x 55 mm	430 x 370 x 55 mm	430 x 370 x 55 mm
CONTIENE Contained / Contient	Cajones 50 / A50 Drawers / Tiroirs	Cajones 10/A50 Drawers 10/B50 Tiroirs 5/C50	Vacio Empty Vide
MATERIAL Material / Matériau	Base PP Base / Base Tapa PS Cover / Couvercle Cajones PS / Drawers / Tiroirs	Base PP Base / Base Tapa PS Cover / Couvercle Cajones PS / Drawers / Tiroirs	Base PP Base / Base Tapa PS Cover / Couvercle
EMBALAJE / UNIDADES Packing / Units Emballage / Unités	4	4	4

Mod.
430/50/25

ESTUCHES CON CAJONES EXTRAÍBLES 80

Organizers with removable drawers 80

Coffret à compartiments amovibles 80



MODELO Model / Modèle	430/80/25	430/80/13	430/80/0
CÓDIGO Code / Code	032004	033001	032400
MEDIDAS Sizes / Mesures	430 x 370 x 85 mm	430 x 370 x 85 mm	430 x 370 x 85 mm
CONTIENE Contained / Contient	Cajones 25/B80 Drawers / Tiroirs	Cajones 5/B80 Drawers 6/C80 Tiroirs 2/D80	Vacio Empty Vide
MATERIAL Material / Matériau	Base PP Base / Base Tapa PS Cover / Couvercle Cajones PS / Drawers / Tiroirs	Base PP Base / Base Tapa PS Cover / Couvercle Cajones PS / Drawers / Tiroirs	Base PP / Base / Base Tapa PS Cover/Couvercle
EMBALAJE / UNIDADES Packing / Units Emballage / Unités	4	4	4

Mod.
430/80/25

CAJONES EXTRAÍBLES DE 50 Y 80

Removable drawers 50 and 80 / Compartiments amovibles de 50 et 80

ESTUCHE CON CAJONES EXTRAÍBLES

Organizers with removable drawers

Coffret à compartiments amovibles

Mod.
330/50/16

MODELO Model / Modèle	330/50/32	330/50/16	330/50/0
CÓDIGO Code / Code	034008	035005	034404
MEDIDAS Sizes / Mesures	330 x 247 x 54 mm	330 x 247 x 54 mm	330 x 247 x 54 mm
CONTIENE Contained / Contient	Cajones 32/A50 Drawers / Tiroirs	Cajones 8/A50 Drawers 4/B50 Tiroirs 4/C50	Cajones Vacío Boxes Empty Tiroirs Vide
MATERIAL Material / Matériau	Base PP Base / Base Tapa PP Cover / Couvercle Cajones PS Drawers / Tiroirs	Base PP Base / Base Tapa PP Cover / Couvercle Cajones PS Drawers / Tiroirs	Base PP Base / Base Tapa PP Cover / Couvercle
EMBALAJE / UNIDADES Packing / Units Emballage / Unités	6	6	6

CAJONES EXTRAÍBLES 50

Removable drawers 50

Compartiments amovibles 50

Accesorios
Accessories / Accessoires

CAJONES EXTRAÍBLES 80

Removable drawers 80

Compartiments amovibles 80

MODELO Model / Modèle	A50	B50	C50
CÓDIGO Code / Code	040009	041006	042003
MEDIDAS Sizes / Mesures	55 x 39 x 47 mm	79 x 55 x 47 mm	109 x 79 x 47 mm
MATERIAL Material / Matériau	Cajones PS / Drawers / Tiroirs	Cajones PS / Drawers / Tiroirs	Cajones PS / Drawers / Tiroirs
EMBALAJE / UNIDADES Packing / Units Emballage / Unités	300	150	75
MODELO Model / Modèle	B80	C80	D80
CÓDIGO Code / Code	043000	044007	045004
MEDIDAS Sizes / Mesures	79 x 55 x 76 mm	109 x 79 x 76 mm	157 x 109 x 76 mm
MATERIAL Material / Matériau	Cajones PS / Drawers / Tiroirs	Cajones PS / Drawers / Tiroirs	Cajones PS / Drawers / Tiroirs
EMBALAJE / UNIDADES Packing / Units Emballage / Unités	90	45	21



MALETAS HERRAMIENTAS ELÉCTRICAS

Cases for electrical tools / Mallettes pour outillage électrique



* Colores especiales disponibles en todos los colores RAL bajo pedido. Consultar
Special colours available in all RAL colours under request. Please send us your enquiry.
Couleurs spéciales disponibles dans toute gamme de coloris RAL, sur demande.



Mod. 40



Mod. 41



Mod. 42

Protección para contenido en todos los modelos
All models have content protection
Protection pour le contenu dans tous les modèles



MODELO Model / Modèle	40	41	42
CÓDIGO Code / Code	140006	141003	142000
MEDIDAS Sizes / Mesures	385 x 330 x 130 mm	385 x 330 x 130 mm	385 x 330 x 130 mm
CONTIENE Contained / Contient	Vacio / Empty / Vide	1 Estuche / Box / Coffret	1 Bandeja Tray / Panier porte-outils
MATERIAL Material / Matériau	PP	PP	PP
COLOR Colour / Couleur	●	● caja / tool box / boîte ● estuche/organizer/coffret	⊙ ● caja / tool box / boîte ● bandeja/tray panier porte-outils
EMBALAJE / UNIDADES Packing / Units Emballage / Unités	7	7	7



Mod. 43



Mod. 44



Mod. 44-B

Protección para contenido en todos los modelos
All models have content protection
Protection pour le contenu dans tous les modèles



MODELO Model / Modèle	43	44	44-B
CÓDIGO Code / Code	143007	144004	144998
MEDIDAS Sizes / Mesures	401 x 352 x 156 mm	430 x 370 x 140 mm	430 x 370 x 140 mm
CONTIENE Contained / Contient	20 Separadores Dividers / Séparateurs	Vacio Empty / Vide	1 Bandeja Tray / Panier porte-outils
MATERIAL Material / Matériau	PP	PP	PP
COLOR Colour / Couleur	●	●	⊙ ● caja / tool box / boîte ● bandeja tray/panier porte-outils
EMBALAJE / UNIDADES Packing / Units Emballage / Unités	6	4	4

Cajas de herramientas y estuches
Tool boxes and organizers
Boîtes à outils et coffrets

Productos de ordenación
Arrangement products
Produits de rangement

Tayg Car
Tayg Car
Tayg Car

Colección hogar
Home collection
Boîtes de rangement Home

Eco Tayg
Eco Tayg
Eco Tayg

Tayg Light
Tayg Light
Tayg Light

Tayg Build
Tayg Build
Tayg Build

Lista de packing
Packing list
Liste d'emballage



CAJAS DE HERRAMIENTAS DE PLÁSTICO

Plastic tool boxes
Boîtes à outils plastiques





CAJAS DE HERRAMIENTAS DE PLÁSTICO

Plastic tool boxes / Boîtes à outils plastiques



* Colores especiales disponibles en todos los colores RAL bajo pedido. Consultar Special colours available in all RAL colours under request. Please send us your enquiry. Couleurs spéciales disponibles dans toute gamme de coloris RAL, sur demande.



Mod. 11 - 12 soporta 120kg
Mod. 11 - 12 supports up to 120kg
Mod. 11 - 12 suporte 120kg



MODELO Model / Modèle	20	21	22	23	24	25
--------------------------	----	----	----	----	----	----

CÓDIGO Code / Code	120008	121005	122002	123009	124006	125003
-----------------------	--------	--------	--------	--------	--------	--------

MEDIDAS Sizes / Mesures	310 x 160 x 130 mm 12,20 x 6,30 x 5,12 in	310 x 160 x 130 mm 12,20 x 6,30 x 5,12 in	356 x 184 x 163 mm 14,02 x 7,24 x 6,42 in	356 x 184 x 163 mm 14,02 x 7,24 x 6,42 in	400 x 206 x 188 mm 15,75 x 8,11 x 7,40 in	400 x 206 x 188 mm 15,75 x 8,11 x 7,40 in
----------------------------	--	--	--	--	--	--

CONTIENE Contained / Contient	-	1 Bandeja Tray / Panier porte-outils	1 Bandeja Tray / Panier porte-outils	1 Bandeja/Tray Panier porte-outils 1 Estuche Organizer Coffrett	1 Bandeja Tray Panier porte-outils	1 Bandeja Tray Panier porte-outils 1 Estuche Organizer /Coffrett
----------------------------------	---	--	--	--	--	--

MATERIAL Material / Matériau	PP	PP	PP	PP	PP	PP
---------------------------------	----	----	----	----	----	----

EMBALAJE / UNIDADES Packing / Units Emballage / Unités	10	10	6	6	6	6
---	----	----	---	---	---	---



MODELO Model / Modèle	9	10	11	12
--------------------------	---	----	----	----

CÓDIGO Code / Code	109003	110009	111006	112003
-----------------------	--------	--------	--------	--------

MEDIDAS Sizes / Mesures	290 x 170 x 127 mm 11,42 x 6,69 x 5 in	290 x 170 x 127 mm 11,42 x 6,69 x 5 in	356 x 192 x 150 mm 14,02 x 7,56 x 5,91 in	400 x 217 x 166 mm 15,75 x 8,54 x 6,53 in
----------------------------	---	---	--	--

CONTIENE Contained / Contient	Vacío / Empty / Vide	1 Bandeja Tray / Panier porte-outils	1 Bandeja Tray / Panier porte-outils	1 Bandeja Tray / Panier porte-outils
----------------------------------	----------------------	--	--	--

MATERIAL Material / Matériau	PP	PP	PP	PP
---------------------------------	----	----	----	----

EMBALAJE / UNIDADES Packing / Units Emballage / Unités	10	10	6	6
---	----	----	---	---



Bandeja con doble capacidad
Double capacity tray
Plateau avec double capacité



* Colores especiales disponibles en todos los colores RAL bajo pedido. Consultar Special colours available in all RAL colours under request. Please send us your enquiry. Couleurs spéciales disponibles dans toute gamme de coloris RAL, sur demande.



Soporta 120kg
Supports up to 120kg
Supporte 120kg



*Opción Box Pallet
Box Pallet Option
Option box palette

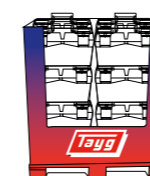

MODELO Model / Modèle	15	16	17	18	19
--------------------------	----	----	----	----	----

CÓDIGO Code / Code	115004	116001	117008	118005	119002
-----------------------	--------	--------	--------	--------	--------

MEDIDAS Sizes / Mesures	500 x 258 x 255 mm 19,68 x 10,16 x 10,04 in	500 x 258 x 255 mm 19,68 x 10,16 x 10,04 in	580 x 290 x 290 mm 22,83 x 11,42 x 11,42 in	580 x 290 x 290 mm 22,83 x 11,42 x 11,42 in	580 x 290 x 290 mm 22,83 x 11,42 x 11,42 in
----------------------------	--	--	--	--	--

CONTIENE Contained / Contient	1 Bandeja / Tray / Panier porte-outils	1 Bandeja / Tray / Panier porte-outils 1 Estuche Organizer / Coffrett	1 Bandeja / Tray / Panier porte-outils	1 Bandeja / Tray / Panier porte-outils 1 Estuche Organizer / Coffrett	1 Bandeja doble / Tray Panier porte-outils 1 Estuche Organizer / Coffrett
----------------------------------	---	--	---	--	---

MATERIAL Material / Matériau	PP CIERRES METÁLICOS Metallic locks Fermetures Métalliques	PP CIERRES METÁLICOS Metallic locks Fermetures Métalliques	PP CIERRES METÁLICOS Metallic locks Fermetures Métalliques	PP CIERRES METÁLICOS Metallic locks Fermetures Métalliques	PP CIERRES METÁLICOS Metallic locks Fermetures Métalliques
---------------------------------	---	---	---	---	---

EMBALAJE / UNIDADES Packing / Units Emballage / Unités	3	3	3	3	3
---	---	---	---	---	---

UNIDAD BOX PALLET Box - Pallet Unit Unité dans box palette	24	24	24	24	24
---	----	----	----	----	----

MEDIDAS BOX PALET Box - Pallet Unit Mesures de la box palette	1000 x 772 x 1016 mm	1000 x 772 x 1016 mm	1160 x 804 x 1160 mm	1160 x 804 x 1160 mm	1160 x 804 x 1160 mm
---	-------------------------	-------------------------	-------------------------	-------------------------	-------------------------



CAJA METÁLICA / CAJA DE PLÁSTICO

Metallic box / Boîte en métal | Plastic box / Boîte en plastique

Material utilizado: Polipropileno.
Material: Polypropylene.
Matériau employé : Polypropylène

Color. Caja negra, bandeja roja, cerraduras y asa.
Colour. Black case, red tray, closures and handle
Couleur. Coffret noir, plateau, fermetures et poignée rouges



Incluye bandeja organizadora
Includes organiser tray
Contient un plateau organisateur



Mod. 32

Con asa de seguridad antiapertura
With anti-open safety handle
Avec poignée de sécurité anti-ouverture

Regla métrica en la tapa
Ruler on the lid
Règle graduée dans le couvercle

Doble cierre y posible cierre manual con candado (no incluido)
Double closure and possibility of locking with a padlock (not included)
Double fermeture et fermeture manuelle possible par cadenas (non inclus)

Soporta hasta 120kg
Withstands up to 120kg
Supporte jusqu'à 120kg

Medidas. 480mm (L) x 258mm (A) x 255mm (H)

Dimensions. 480x258x255mm

Dimensions. 480x258x255mm

PROFESIONAL



* Colores especiales disponibles en todos los colores RAL bajo pedido. Consultar
Special colours available in all RAL colours under request. Please send us your enquiry.
Couleurs spéciales disponibles dans toute gamme de coloris RAL, sur demande.



Soporta 120kg
Supports up to 120kg
Supporte 120kg



Asa de Seguridad Antiapertura
Anti Opening Lock System
Poignée de sécurité anti ouverture



403

MODELO
Model / Modèle

CÓDIGO
Code / Code

MEDIDAS LxAxH
Sizes / Mesures

CONTIENE
Contained / Contient

MATERIAL
Material / Matériau

EMBALAJE / UNIDADES
Packing / Units
Emballage / Unités

404 x 200 x 240
15,91 x 7,87 x 9,45 in

2 Bandejas
Tray / Panier porte-outils

Chapa acero + pintura epoxi
Sheet steel+ epoxy paint
Plaque acier + peinture epoxi

1



Mod. 403



30



31



32



33

MODELO
Model / Modèle

CÓDIGO
Code / Code

MEDIDAS LxAxH
Sizes / Mesures

CONTIENE
Contained / Contient

MATERIAL
Material / Matériau

EMBALAJE / UNIDADES
Packing / Units
Emballage / Unités

130007

445 x 235 x 230 mm
17,52 x 9,25 x 9,05 in

1 Bandeja / Tray /
Panier porte-outils

PP

6

131004

445 x 235 x 230 mm
17,52 x 9,25 x 9,05 in

1 Bandeja / Tray /
Panier porte-outils
1 Estuche
Organizer / Coffrett

PP

6

132001

480 x 258 x 255 mm
18,90 x 10,16 x 10,04 in

1 Bandeja / Tray /
Panier porte-outils

PP

3

133008

480 x 258 x 255 mm
18,90 x 10,16 x 10,04 in

1 Bandeja / Tray /
Panier porte-outils
1 Estuche
Organizer / Coffrett

PP

3



CAJAS DE HERRAMIENTAS DE PLÁSTICO - ALUMINIO

Plastic - aluminium tool boxes / Boîtes à outils plastiques et aluminium

PROFESIONAL



* Colores especiales disponibles en todos los colores RAL bajo pedido. Consultar Special colours available in all RAL colours under request. Please send us your enquiry. Couleurs spéciales disponibles dans toute gamme de coloris RAL, sur demande.



Soporta 120kg
Supports up to 120kg
Supporte 120kg



Asa de Seguridad Antiapertura
Anti Opening Lock System
Poignée de sécurité anti ouverture



Bandeja con doble capacidad
Two-level tray
Plateau avec double capacité

* 149009
Accesorio-cinta y soportes
Accessory-strap, frame
Accessoires, bandeau et supports



34-1B



34



35



36

MODELO Model / Modèle	34-1B	34	35	36
CÓDIGO Code / Code	134999	134005	135002	136009
MEDIDAS Sizes / Mesures	580 x 285 x 290 mm 22,83 x 11,22 x 11,42 in	580 x 285 x 290 mm 22,83 x 11,22 x 11,42 in	580 x 285 x 290 mm 22,83 x 11,22 x 11,42 in	580 x 285 x 290 mm 22,83 x 11,22 x 11,42 in
CONTIENE Contained / Contient	1 Bandeja / Tray Panier porte-outils	1 Bandeja / Tray Panier porte-outils 1 Estuche Organizer / Coffrett	2 Bandejas / Tray / Panier porte-outils 1 Estuche Organizer / Coffrett	1 Bandeja doble Double tray / Panier porte-outils 1 Estuche Organizer / Coffrett
MATERIAL Material / Matériau	PP	PP	PP	PP
EMBALAJE / UNIDADES Packing / Units Emballage / Unités	3	3	3	3

PROFESIONAL



* Colores especiales disponibles en todos los colores RAL bajo pedido. Consultar Special colours available in all RAL colours under request. Please send us your enquiry. Couleurs spéciales disponibles dans toute gamme de coloris RAL, sur demande.



Soporta 120kg
Supports up to 120kg
Supporte 120kg



Asa de Seguridad Antiapertura
Anti Opening Lock System
Poignée de sécurité anti ouverture



Mod. 450-E



400



450



450-E

MODELO Model / Modèle	400	450	450-E
CÓDIGO Code / Code	162008	163005	164002
MEDIDAS Sizes / Mesures	400 x 225 x 190 mm 15,75 x 8,86 x 7,48 in	450 x 285 x 250 mm 17,72 x 11,22 x 9,84 in	450 x 285 x 250 mm 17,72 x 11,22 x 9,84 in
CONTIENE Contained / Contient	1 Bandeja Tray / Panier porte-outils	1 Bandeja Tray / Panier porte-outils	1 Bandeja Tray / Panier porte-outils 1 Estuche Organizer / Coffrett
MATERIAL Material / Matériau	PP	PP Asa Aluminio / Aluminium handle / Poignée Aluminium Cierres metálicos / Metallic locks / Attaches Métalliques	PP Asa Aluminio / Aluminium handle / Poignée Aluminium Cierres metálicos / Metallic locks / Attaches Métalliques
COLOR Colour / Couleur	6	3	3
EMBALAJE / UNIDADES Packing / Units Emballage / Unités	6	4	4

Cajas de herramientas y estuches
Tool boxes and organizers
Boîtes à outils et coffrets

Productos de ordenación
Arrangement products
Produits de rangement

Tayg Car
Tayg Car
Tayg Car

Colección hogar
Home collection
Boîtes de rangement Home

Eco Tayg
Eco Tayg
Eco Tayg

Tayg Light
Tayg Light
Tayg Light

Tayg Build
Tayg Build
Tayg Build

Lista de packing
Packing list
Liste d'emballage



CAJAS DE HERRAMIENTAS DE PLÁSTICO - ALUMINIO

Plastic - aluminium tool boxes / Boîtes à outils plastiques et aluminium

PROFESIONAL



* Colores especiales disponibles en todos los colores RAL bajo pedido. Consultar Special colours available in all RAL colours under request. Please send us your enquiry. Couleurs spéciales disponibles dans toute gamme de coloris RAL, sur demande.



Soporta 120kg Supports up to 120kg Suporte 120kg



Asa de Seguridad Antiapertura Anti Opening Lock System Poignée de sécurité anti ouverture



Mod. 600 - E



Mod. 500 - E



500



500-E



600



600-E

MODELO Model / Modèle	500	500-E	600	600-E
CÓDIGO Code / Code	165009	166006	167003	168000
MEDIDAS Sizes / Mesures	500 x 295 x 270 mm 19,68 x 11,61 x 10,63 in	500 x 295 x 270 mm 19,68 x 11,61 x 10,63 in	600 x 305 x 295 mm 23,62 x 12,01 x 11,61 in	600 x 305 x 295 mm 23,62 x 12,01 x 11,61 in
CONTIENE Contained / Contient	1 Bandeja / Tray Panier porte-outils	1 Bandeja / Tray Panier porte-outils 1 Estuche Organizer / Coffret	1 Bandeja / Tray Panier porte-outils	1 Bandeja / Tray Panier porte-outils 1 Estuche Organizer / Coffret
MATERIAL Material / Matériau	PP Asa Aluminio Aluminium handle Poignée Aluminium Cierres metálicos Metallics locks Attaches Métalliques	PP Asa Aluminio Aluminium handle Poignée Aluminium Cierres metálicos Metallics locks Attaches Métalliques	PP Asa Aluminio Aluminium handle Poignée Aluminium Cierres metálicos Metallics locks Attaches Métalliques	PP Asa Aluminio Aluminium handle Poignée Aluminium Cierres metálicos Metallics locks Attaches Métalliques
EMBALAJE / UNIDADES Packing / Units Emballage / Unités	3	3	3	3

Cierres de seguridad Security locks Sécurité anti ouverture



Mod. 550-E

*Detalle asa de seguridad antiapertura Anti opening lock system detail Poignée de sécurité anti ouverture de détail



550 - B



550 - E

MODELO Model / Modèle	550 - B	550 - E
CÓDIGO Code / Code	170003	171000
MEDIDAS Sizes / Mesures	550 x 300 x 275 mm 21,65 x 11,81 x 10,83 in	550 x 300 x 275 mm 21,65 x 11,81 x 10,83 in
CONTIENE Contained / Contient	1 Bandeja Tray / Panier porte-outils	1 Estuche Organizer / Coffret
MATERIAL Material / Matériau	PP Asa Aluminio / Aluminium handle / Poignée Aluminium Cierres metálicos / Metallics locks / Attaches Métalliques	PP Asa Aluminio / Aluminium handle / Poignée Aluminium Cierres metálicos / Metallics locks / Attaches Métalliques
EMBALAJE / UNIDADES Packing / Units Emballage / Unités	3	3



* Colores especiales disponibles en todos los colores RAL bajo pedido. Consultar Special colours available in all RAL colours under request. Please send us your enquiry. Couleurs spéciales disponibles dans toute gamme de coloris RAL, sur demande.



Soporta 120kg Supports up to 120kg Suporte 120kg



Asa de Seguridad Antiapertura Anti Opening Lock System Poignée de sécurité anti ouverture



Abierto Opened Ouvert

Cerrado Losed Fermé

Cajas de herramientas y estuches
Tool boxes and organizers
Boîtes à outils et coffrets

Productos de ordenación
Arrangement products
Produits de rangement

Tayg Car
Tayg Car
Tayg Car

Colección hogar
Home collection
Boîtes de rangement Home

Eco Tayg
Eco Tayg
Eco Tayg

Tayg Light
Tayg Light
Tayg Light

Tayg Build
Tayg Build
Tayg Build

Lista de packing
Packing list
Liste d'emballage



CAJAS DE HERRAMIENTAS DE PLÁSTICO - ALUMINIO

Plastic - aluminium tool boxes | Mobile tool chest

PROFESIONAL



* Colores especiales disponibles en todos los colores RAL bajo pedido. Consultar
Special colours available in all RAL colours under request. Please send us your enquiry.
Couleurs spéciales disponibles dans toute gamme de coloris RAL, sur demande.



Soporta 120kg
Supports up to 120kg
Supporte 120kg



Asa de Seguridad Antiapertura
Anti Opening Lock System
Poignée de sécurité anti ouverture



Mod.
650 - B



650 - B



650 - E

MODELO Model / Modèle	650 - B	650 - E
CÓDIGO Code / Code	172007	173004
MEDIDAS Sizes / Mesures	650 x 300 x 295 mm 25,59 x 11,81 x 11,61 in	650 x 300 x 295 mm 25,59 x 11,81 x 11,61 in
CONTIENE Contained / Contient	1 Bandeja Tray / Panier porte-outils	1 Estuche Organizer / Coffret
MATERIAL Material / Matériau	PP Asa Aluminio / Aluminium handle / Poignée Aluminium Cierres metálicos / Metallic locks / Attaches Métalliques	PP Asa Aluminio / Aluminium handle / Poignée Aluminium Cierres metálicos / Metallic locks / Attaches Métalliques
EMBALAJE / UNIDADES Packing / Units Emballage / Unités	2	2

COFRE HERRAMIENTAS MOVIL

Boîtes à outils plastiques et aluminium | Coffre à outils mobile

PROFESIONAL



* Colores especiales disponibles en todos los colores RAL bajo pedido. Consultar
Special colours available in all RAL colours under request. Please send us your enquiry.
Couleurs spéciales disponibles dans toute gamme de coloris RAL, sur demande.



Soporta 120kg
Supports up to 120kg
Supporte 120kg



Palomillas
Brackets
Écrou moleté

Goma eva
EVA rubber
EVA gomme

Mod.50



50



51



53



54

MODELO Model / Modèle	50	51	53	54
CÓDIGO Code / Code	150005	151002	153006	154003
MEDIDAS Sizes / Mesures	675 x 472 x 416 mm 26,57 x 18,58 x 16,38 in	675 x 472 x 416 mm 26,57 x 18,58 x 16,38 in	775 x 472 x 493 mm 30,51 x 18,58 x 19,41 in	775 x 472 x 493 mm 30,51 x 18,58 x 19,41 in
CONTIENE Contained / Contient	2 Bandejas / Tray / Panier porte-outils 5 Palomillas Small Bracket / Écrou moleté	2 Bandejas / Tray / Panier porte-outils 2 Estuche Organizer / Coffret	2 Bandejas / Tray / Panier porte-outils 5 Palomillas Small Bracket /Coffret	2 Bandejas / Tray / Panier porte-outils 2 Estuche Organizer / Coffret
MATERIAL Material / Matériau	PP	PP	PP	PP
EMBALAJE / UNIDADES Packing / Units Emballage / Unités	1	1	1	1



TRAIL BOX / SAFETY TOOL BOX

Trail box / Safety tool box
Servanter de chantier / Safety tool box





TRAIL BOX

Trail box / Servanter de chantier



* Colores especiales disponibles en todos los colores RAL bajo pedido. Consultar Special colours available in all RAL colours under request. Please send us your enquiry. Couleurs spéciales disponibles dans toute gamme de coloris RAL, sur demande.



Soporta 120kg
Supports up to 120kg
Supporte 120kg



Mod. 57

Mod. 58

Goma eva
EVA rubber
EVA gomme



57



58

MODELO Model / Modèle	57	58
CÓDIGO Code / Code	157004	158001
MEDIDAS Sizes / Mesures	470 x 290 x 630 mm 18,50 x 11,42 x 24,80 in	470 x 290 x 630 mm 18,50 x 11,42 x 24,80 in
CONTIENE Contained / Contient	1 Bandeja Tray / Panier porte-outils	1 Bandeja Tray / Panier porte-outils 1 Estuches/ Organizer / Coffrett
MATERIAL Material / Matériau	PP	PP Cierres metálicos Metallic locks / Attaches Métalliques
EMBALAJE / UNIDADES Packing / Units Emballage / Unités	1	1

SAFETY TOOL BOX

Safety tool box / Safety tool box

PROFESIONAL



Soporta 120kg
Supports up to 120kg
Supporte 120kg



Cierres y asa luminiscente
Luminiscent lock and handle
Poignée et fermoirs luminescents



Diseñado para la seguridad
Safety design
Conçu pour la sécurité



MODELO Model / Modèle	Estuche 46-26 STB	Maleta 40 STB	Caja 34 STB	Cofre 54 STB	Pack STB
CÓDIGO Code / Code	146800	140808	134807	154805	154980
MEDIDAS Sizes / Mesures	378 x 290 x 61mm	385 x 330 x 130mm	580 x 285 x 290mm	775 x 472 x 493mm	775 x 472 x 493mm
CONTIENE Contained Contient	21 Separadores Dividers/ Séparateurs	-	1 Bandeja / Tray / Panier porte-outils	2 Bandeja / Tray / Panier porte-outils	1 cofre, 1 maleta, 1 caja y 1 estuche 1 chest, 1 Cases, 1 tool box, 1 Organizer 1 coffre, 1 Mallette, 1 boîte, 1 Coffrett
EMBALAJE / UNIDADES Packing / Units Emballage / Unités	6	7	3	1	1



TRAIL BOX PRO

Trail box pro / Servanter de chantier pro



* Colores especiales disponibles en todos los colores RAL bajo pedido. Consultar Special colours available in all RAL colours under request. Please send us your enquiry. Couleurs spéciales disponibles dans toute gamme de coloris RAL, sur demande.



Soporta 120kg
Supports up to 120kg
Supporte 120kg



Mod. 59

PROFESIONAL



Cierre de seguridad: levantar y girar para abrir
Security lock: pull up and turn to open
Fermeture de sécurité: lever et tourner pour ouvrir



PROFESIONAL



* Colores especiales disponibles en todos los colores RAL bajo pedido. Consultar Special colours available in all RAL colours under request. Please send us your enquiry. Couleurs spéciales disponibles dans toute gamme de coloris RAL, sur demande.



Soporta 120kg
Supports up to 120kg
Supporte 120kg



*Disponibles accesorios de venta por separado
Available Accessories sold separately
Accessoires disponibles a la vente séparément



MODELO Model / Modèle	59
CÓDIGO Code / Code	159008
MEDIDAS Sizes / Mesures	500 x 410 x 770 mm 19,68 x 16,14 x 30,31 in
CONTIENE Contained / Contient	1 Estuche 430/50/25 / Organizer / Coffret 1 Estuche 430/80/13 / Organizer / Coffret 1 Estuche 430/80/0 / Organizer / Coffret 1 Maleta 44B / Bag / Mallette 1 Maleta Cajón Drawer suitcase / Mallette tiroir
MATERIAL Material / Matériau	PP Cajones y tapa transparente-PS Drawers and transparent cover-PS Tiroirs et couvercles transparents-PS
EMBALAJE / UNIDADES Packing / Units Emballage / Unités	1



CAJA DE HERRAMIENTAS COLECCIÓN BÁSICA

Basic line tool boxes / Boîtes à outils Basic Line



* Colores especiales disponibles en todos los colores RAL bajo pedido. Consultar Special colours available in all RAL colours under request. Please send us your enquiry. Couleurs spéciales disponibles dans toute gamme de coloris RAL, sur demande.



Mod. Multibox n1



MODELO Model / Modèle	AccessoryBox 01	AccessoryBox 02	AccessoryBox 03	Multibox n°1 BL
CÓDIGO Code / Code	022555	023552	024559	301551
MEDIDAS Sizes / Mesures	312 x 238 x 51 mm	388 x 290 x 61 mm	460 x 350 x 81 mm	335 x 250 x 275 mm
CONTIENE Contained / Contient	21 Separadores Dividers / Séparateurs	21 Separadores Dividers / Séparateurs	21 Separadores Dividers / Séparateurs	Módulo + 4 estuches 22 + asa Piece + 4 organizers 22 + handle Module + 4 coffret 22 + poignée
MATERIAL Material / Matériau	PP	PP	PP	PP
EMBALAJE / UNIDADES Packing / Units Emballage / Unités	6	6	5	2



* Colores especiales disponibles en todos los colores RAL bajo pedido. Consultar Special colours available in all RAL colours under request. Please send us your enquiry. Couleurs spéciales disponibles dans toute gamme de coloris RAL, sur demande.



Soporta 120kg
Supports up to 120kg
Supporte 120kg



Mod. ToolBox 16"



MODELO Model / Modèle	ToolBox 12"	ToolBox 16"	ToolBox 20"
CÓDIGO Code / Code	110559	112553	115554
MEDIDAS Sizes / Mesures	290 x 170 x 127 mm	400 x 217 x 166 mm	500 x 258 x 255 mm
CONTIENE Contained / Contient	1 Bandeja Tray / Panier porte-outils	1 Bandeja Tray / Panier porte-outils	1 Bandeja Tray / Panier porte-outils
MATERIAL Material / Matériau	PP	PP	PP
EMBALAJE / UNIDADES Packing / Units Emballage / Unités	10	6	3



BOLSAS, MOCHILAS, CINTURONES Y TROLLEYS

Bags, backpacks, belts and trolleys
Sacs, sacs à dos, ceintures et sac à dos à roulette





BOLSAS HERRAMIENTAS

Tool bags / Sacs à outils



Con 4 tacos de apoyo en el fondo
With 4 rubber feet
Avec 4 taquets d'appui dans le fond

Mod. BN-1
(13")

NOVEDAD
NEW / NOUVEAUTÉ

Mod. BN-7
(20")

Mod. BN-3
(18")

Bolsa Herramientas BN-1 (13")
Tool Bag BN-1(13")
Sacs à outils BN-1(13")

Bolsa Herramientas BN-3 (18")
Tool Bag BN-3(18")
Sacs à outils BN-3(18")

Bolsa Herramientas BN-7 (20")
Tool Bag BN-7 (20")
Sacs à outils BN-7 (20")

MODELO Model / Modèle	080005	082009	097003
CÓDIGO Code / Code	080005	082009	097003
MEDIDAS Sizes / Mesures	345 x 220 x 225 mm	455 x 250 x 265 mm	500 x 220 x 290 mm
MATERIAL Material / Matériau	Poliéster 600D Polyester 600D Polyester 600D	Bolsa Poliéster 600D Fondo Polietileno Polyester 600D Bag Base Polytene Polyester 600D Sac Fond Polyéthylène	Poliéster 600D Polyester 600D Polyester 600D
EMBALAJE / UNIDADES Packing / Units Emballage / Unités	6 U - 6 pcs.	6 U - 6 pcs.	6 U - 6 pcs.

CINTURÓN HERRAMIENTAS

Tool belt / Ceintures outils

PROFESIONAL



Mod.

Cinturón herramientas doble-profesional
Professional double tool pouch
Ceinture porte-outils double professionnelle



Mod.

Cinturón herramientas doble
Double tool pouch
Ceinture porte-outils double



MODELO Model / Modèle	Cinturón herramientas simple Simple tool pouch Ceinture porte-outils simple	Cinturón herramientas doble Double tool pouch Ceinture porte-outils double	Cinturón herramientas simple-profesional Professional simple tool pouch Ceinture porte-outils simple professionnelle	Cinturón herramientas doble-profesional Professional double tool pouch Ceinture porte-outils double professionnelle
CÓDIGO Code / Code	089602	090608	091605	092602
MATERIAL Material / Matériau	Poliéster 600D Polyester 600D Polyester 600D	Poliéster 600D Polyester 600D Polyester 600D	Poliéster 600D Polyester 600D Polyester 600D	Poliéster 600D Polyester 600D Polyester 600D
EMBALAJE / UNIDADES Packing / Units Emballage / Unités	10 U - 10 pcs.	6 U - 6 pcs.	10 U - 10 pcs.	6 U - 6 pcs.

Cajas de herramientas y estuches
Tool boxes and organizers
Boîtes à outils et coffrets

Productos de ordenación
Arrangement products
Produits de rangement

Tayg Car
Tayg Car
Tayg Car

Colección hogar
Home collection
Boîtes de rangement Home

Eco Tayg
Eco Tayg
Eco Tayg

Tayg Light
Tayg Light
Tayg Light

Tayg Build
Tayg Build
Tayg Build

Lista de packing
Packing list
Liste d'emballage



MOCHILA HERRAMIENTAS

Backpack / Sacs à dos à outils



Ligero
Lightweight
Légère



Impermeable
Waterproof
Imperméable



Tamaño 33L
Size 33L
Taille XL 33L

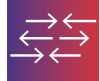

Resistente
Resistant
Résistante



Puerto de salida USB
USB port
Port de sortie USB



Amplios compartimentos exteriores
Wide external compartments
Amplis compartiments extérieurs



Mod.

Bolsa herramientas Roll tool / Roll tool bag / Rouleau à outils



Mod.
Bucket bag



Bolsa Herramientas roll tool
Roll tool Bag
Rouleau à outils



Mod. BP20

Base reforzada, resistente a productos químicos y agua
Reinforced base, resistant to chemicals and water.
Base renforcée, résistante aux produits chimiques et à l'eau



Bucket bag



Mod. TR20



Compartimento interior extraíble
Internal removable compartment
Compartiment intérieur amovible



Asa telescópica
Telescopic handle
Manche télescopique



Ligero
Lightweight
Légère



Impermeable
Waterproof
Imperméable



Tamaño 33L
Size 33L
Taille XL 33L



Resistente
Resistant
Résistante



Mod. TR20

MODELO
Model / Modèle

CÓDIGO
Code / Code

MEDIDAS
Sizes / Mesures

CAPACIDAD
Capacity / Capacité

MATERIAL
Material / Matériau

EMBALAJE / UNIDADES
Packing / Units
Emballage / Unités

098611

380 x 210 x 520 mm

33 Ltrs

Poliéster 1200D y ruedas en PU
Polyester 1200D and wheels in PU
Polyester 1200D et roues PU

1

MODELO
Model / Modèle

BP20

CÓDIGO
Code / Code

097614

MEDIDAS
Sizes / Mesures

390 x 190 x 490 mm

CAPACIDAD
Capacity / Capacité

33 Ltrs

MATERIAL
Material / Matériau

Poliéster 600D
Polyester / Polyester

EMBALAJE / UNIDADES
Packing / Units
Emballage / Unités

2

099601

380 x 500 x 5 mm

-

Poliéster 600D
Polyester 600D
Polyester 600D

40 U

099618

450 x 300 mm - Ø300mm

-

Poliéster 600D
Polyester 600D
Polyester 600D

6 U



CINTURONES Y SOPORTES DE CUERO

Leather belts and holders / Ceintures et supports à cuir

MADE IN SPAIN



* Con trabilla para colgar.
With belt loop to hang.
Avec boucles de ceinture à accrocher.

Mod.

Soporte electricista
Electrician holder
Support electricien

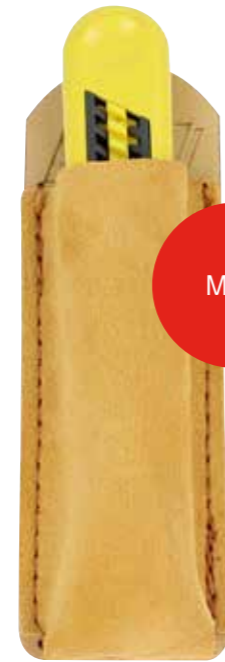

Mod.

Soporte cutter
Cutter holder
Support cutter



Mod.

Soporte martillo
Hammer holder
Support marteau

* Con trabilla para colgar.
With belt loop to hang.
Avec boucles de ceinture à accrocher.

* Con trabilla para colgar.
With belt loop to hang.
Avec boucles de ceinture à accrocher.

Mod.

Guarda tijeras podar
Pruning shears holder
Support sécateurs



MODELO
Model / Modèle

Soporte electricista
Electrician holder
Support electricien

Guarda tijeras podar
Pruning shears holder
Support sécateurs

Soporte cutter
Cutter holder
Support cutter

Soporte martillo
Hammer holder
Support marteau

CÓDIGO
Code / Code

083600

084607

082603

081606

MATERIAL
Material / Matériau

Cuero natural
Natural leather
Cuir naturel

Cuero natural
Natural leather
Cuir naturel

Cuero natural
Natural leather
Cuir naturel

Cuero natural
Natural leather
Cuir naturel

EMBALAJE /
UNIDADES
Packing / Units
Emballage / Unités

10

10

10

10

PROFESIONAL

MADE IN SPAIN

Cinturón ajustable
Adjustable belt
Ceinture ajustable



5 compartimentos
5 compartments
5 compartiments

Mod.

Cinturón soporte simple
Simple hold belt
Ceinture support simple

Soporte para martillo
Hammer holder
Support pour marteau

Cinturón ajustable
Adjustable belt
Ceinture ajustable



11 compartimentos
11 compartments
11 compartiments

Mod.

Cinturón soporte profesional
Professional hold belt
Ceinture support Professionnel

Soporte para martillo
Hammer holder
Support pour marteau

MODELO
Model / Modèle

Cinturón soporte simple
Simple hold belt
Ceinture support simple

Cinturón soporte profesional
Professional hold belt
Ceinture support professionnel

CÓDIGO
Code / Code

086601

087608

MATERIAL
Material / Matériau

Cuero natural
Natural leather / Cuir naturel

Cuero natural
Natural leather / Cuir naturel

EMBALAJE /
UNIDADES
Packing / Units
Emballage / Unités

10

10

PRODUCTOS DE ORDENACIÓN

Arrangement products | Produits de rangement
Produkten für Aufbewahrung



GAVETAS APILABLES 50

Stackable drawers
Bac à bec empilable
Stapelsichtboxen



GAVETA PLEGABLE APILABLE 52

Stackable folding drawer
Bac à bec pliable empilable
Faltbare Stapelsichtboxen



TABLA DE RESISTENCIA A LA COMPRESIÓN | KIT DE COLGAR 54

Compression strength table | Hanging kit
Tableau de résistance à la compression |
Kit a accrocher
Druckfestigkeitstabelle | Kit zum Aufhängen



EURO-CAJAS PARA ALMACÉN Y TRANSPORTE | EURO-CAJAS CON TAPA PARA ALMACÉN Y TRANSPORTE 56

Multi purpose Heavy Duty Boxes | Multi
purpose Heavy Duty Boxes with cover
Bacs emboîtables pour stockage et
transport | Conteneurs avec couvercle pour
le stockage et le transport
Euroboxen für Lagerung und Transport |
Euroboxen mit Deckel für Lagerung und
Transport



ESTANTERÍAS. MÓDULO CAIRO 58

Shelves. Cairo model
Étagère. Cairo modèle
Regale. Cairo Modul



KIT ESTANTERÍA METÁLICA | CAJONES ESTANTERÍAS 60

Metal shelves kit | Drawers for shelves
Set étagères métalliques | Tiroirs étagères
Kit für Metallregal | Schubladen für Regale



KIT ESTANTERÍA METÁLICA CON CAJONES | CONTENEDORES BASCULANTES 62

Boxes with mobile dividers |
Cabinet with tiltable drawers
Set étagère métallique avec tiroirs |
Bacs basculants
Kit für Metallregal und Schubladen |
Kippbare Behälter



ESTANTERÍAS METÁLICAS | KIT ESTANTERÍA METÁLICA 64

Metal shelves | Metal shelves kit
Étagères métalliques | Set étagères métalliques
Für Metallregal | Kit für Metallregal



KIT ESTANTERÍA PLÁSTICO 66

Plastic shelves kit
Set étagère plastique
Kit für Kunststoffregal



MÓDULOS METÁLICOS | CONTENEDORES CAJONES 68

Metal stackable modules |
Cabinet with drawers
Modules métalliques | Casiers à tiroirs
Stapelbare Metallmodule |
Behälter mit Schubladen



CLASIFICADORES APILABLES | MÓDULOS APILABLES 70

Stackable classifiers unit | Stackable modules
Racks de rangement apilables |
Modules empilables
Stapelbare Sortierregale | Stapelbare Module



MULTIBOX 72

Multibox
Multibox
Multibox



GAVETAS APILABLES

Stackable drawers / Bac à bec empilable



* Colores especiales disponibles en todos los colores RAL bajo pedido. Consultar Special colours available in all RAL colours under request. Please send us your enquiry. Couleurs spéciales disponibles dans toute gamme de coloris RAL, sur demande.



Apto para uso alimentario. Registro sanitario nº 3904321/V Food Graded. Health registration nº 3904321/V Apte pour l'utilisation alimentaire. Registre sanitaire nº 3904321/V

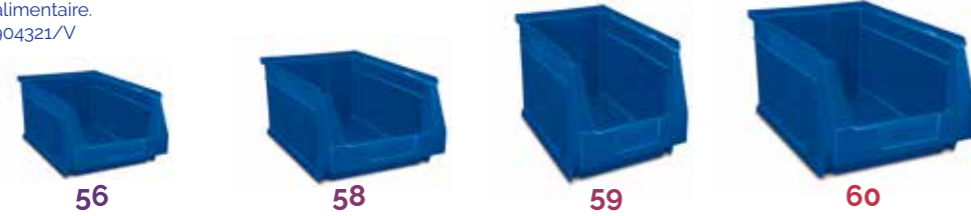

MODELO
Model / Modèle

CÓDIGO Code / Code	● 256028 ● 256103 ○ 256349	● 258022 ● 258107 ○ 258343	● 259029 ● 259104 ○ 259340	● 260025 ● 260100 ○ 260346
-----------------------	----------------------------------	----------------------------------	----------------------------------	----------------------------------

MEDIDAS Sizes / Mesures	420 x 270 x 175 mm	500 x 303 x 200 mm	500 x 303 x 300 mm	600 x 400 x 300 mm
----------------------------	--------------------	--------------------	--------------------	--------------------

CAPACIDAD (LITROS) Capacity (Litres) Capacité (Litres)	13.9	22.2	34	51.3
---	------	------	----	------

MATERIAL Material / Matériau	PP	PP	PP	PP
---------------------------------	----	----	----	----

EMBALAJE / UNIDADES Packing / Units Emballage / Unités	8	12	6	6
---	---	----	---	---

Etiquetas descargables en la web
Downloadable labels on the web / Étiquettes téléchargeables sur le web

Etiquetas descargables en la web
Downloadable labels on the web / Étiquettes téléchargeables sur le web



* Colores especiales disponibles en todos los colores RAL bajo pedido. Consultar Special colours available in all RAL colours under request. Please send us your enquiry. Couleurs spéciales disponibles dans toute gamme de coloris RAL, sur demande.



Uso industrial
Industrial use
Usage industriel

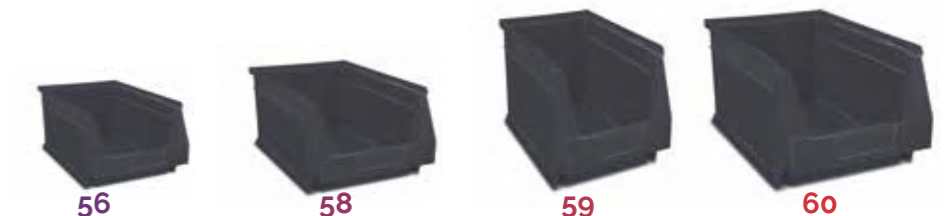

MODELO
Model / Modèle

CÓDIGO Code / Code	● 256066 ● 256110	● 258060 ● 258114	● 259067 ● 259111	● 260063 ● 260117
-----------------------	----------------------	----------------------	----------------------	----------------------

MEDIDAS Sizes / Mesures	420 x 270 x 175 mm	500 x 303 x 200 mm	500 x 303 x 300 mm	600 x 400 x 300 mm
----------------------------	--------------------	--------------------	--------------------	--------------------

CAPACIDAD (LITROS) Capacity (Litres) Capacité (Litres)	13.9	22.2	34	51.3
---	------	------	----	------

MATERIAL Material / Matériau	PP	PP	PP	PP
---------------------------------	----	----	----	----

EMBALAJE / UNIDADES Packing / Units Emballage / Unités	8	12	6	6
---	---	----	---	---

*Gaveta Ref. 260063 modelo compatible con euroroller. Drawer Ref. 260063, model compatible with euroroller / Tiroir Ref. 260063 modèle compatible avec euroroller



MODELO
Model / Modèle

CÓDIGO Code / Code	● 251023 ● 251108 ○ 251344	● 252020 ● 252105 ○ 252341	● 253027 ● 253102 ○ 253348	● 254024 ● 254109 ○ 254345	● 255021 ● 255106 ○ 255342
-----------------------	----------------------------------	----------------------------------	----------------------------------	----------------------------------	----------------------------------

MEDIDAS Sizes / Mesures	170 x 100 x 80 mm	236 x 160 x 130 mm	336 x 160 x 130 mm	336 x 216 x 155 mm	336 x 216 x 200 mm
----------------------------	-------------------	--------------------	--------------------	--------------------	--------------------

CAPACIDAD (LITROS) Capacity (Litres) Capacité (Litres)	0.8	3.2	4.8	7.7	10.1
---	-----	-----	-----	-----	------

MATERIAL Material / Matériau	PP	PP	PP	PP	PP
---------------------------------	----	----	----	----	----

EMBALAJE / UNIDADES Packing / Units Emballage / Unités	24	15	10	12	8
---	----	----	----	----	---



MODELO
Model / Modèle

CÓDIGO Code / Code	● 251061 ● 251115	● 252068 ● 252112	● 253065 ● 253119	● 254062 ● 254116	● 255069 ● 255113
-----------------------	----------------------	----------------------	----------------------	----------------------	----------------------

MEDIDAS Sizes / Mesures	170 x 100 x 80 mm	236 x 160 x 130 mm	336 x 160 x 130 mm	336 x 216 x 155 mm	336 x 216 x 200 mm
----------------------------	-------------------	--------------------	--------------------	--------------------	--------------------

CAPACIDAD (LITROS) Capacity (Litres) Capacité (Litres)	0.8	3.2	4.8	7.7	10.1
---	-----	-----	-----	-----	------

MATERIAL Material / Matériau	PP	PP	PP	PP	PP
---------------------------------	----	----	----	----	----

EMBALAJE / UNIDADES Packing / Units Emballage / Unités	24	15	10	12	8
---	----	----	----	----	---

Cajas de herramientas y estuches
Tool boxes and organizers
Boîtes à outils et coffrets

Productos de ordenación
Arrangement products
Produits de rangement

Tayg Car
Tayg Car
Tayg Car

Colección hogar
Home collection
Boîtes de rangement Home

Eco Tayg
Eco Tayg
Eco Tayg

Tayg Light
Tayg Light
Tayg Light

Tayg Build
Tayg Build
Tayg Build

Lista de packing
Packing list
Liste d'emballage



GAVETA PLEGABLE APILABLE

Stackable folding drawer / Bac à bec pliable empilable



* Colores especiales disponibles en todos los colores RAL bajo pedido. Consultar Special colours available in all RAL colours under request. Please send us your enquiry. Couleurs spéciales disponibles dans toute gamme de coloris RAL, sur demande.



Apto para uso alimentario. Registro sanitario nº 3904321/V Food Graded. Health registration nº 3904321/V Apte pour l'utilisation alimentaire. Registre sanitaire nº 3904321/V



Eficiencia logística Logistic efficiency Efficacité logistique



Fácil transporte
Easy and optimized
Transport facile



MODELO Model / Modèle	54P	56P	59P	60P
CÓDIGO Code / Code	● 204029 ⊖ 204340	● 206023 ⊖ 206344	● 209024 ⊖ 209345	● 210020 ⊖ 210341
MEDIDAS Sizes / Mesures	336 x 216 x 175 mm	420 x 270 x 200 mm	500 x 303 x 275 mm	600 x 400 x 325 mm
CAPACIDAD (LITROS) Capacity (Litres) Capacité (Litres)	8,5	15	30	55
MATERIAL Material / Matériau	PP	PP	PP	PP
EMBALAJE / UNIDADES Packing / Units Emballage / Unités	11	11	8	6



Etiquetas descargables en la web
Downloadable labels on the web / Étiquettes téléchargeables sur le web



Etiquetas descargables en la web
Downloadable labels on the web / Étiquettes téléchargeables sur le web



TOP VENTAS
BEST SELLER
TOP VENTES



Fácil transporte
Easy and optimized
Transport facile

*Gaveta Ref. 52 y Ref. 52P son apilable y compatibles con gaveta regulable Gaveta Ref. 53 y Ref. 53P son apilable y compatibles con gaveta regulable Drawer Ref. 52 and Ref. 52P stackable and compatible with regular bins Drawer Ref. 53 and Ref. 53P stackable and compatible with regular bins Tiroir Ref.52 et Ref.52P sont apilables et compatibles avec tiroir réglable Tiroir Ref.53 et Ref.53P sont apilables et compatibles avec tiroir réglable



Información resistencia técnica en la página 54
Technical resistance information on the page 54
Information de la résistance technique à la page 54



* Colores especiales disponibles en todos los colores RAL bajo pedido. Consultar Special colours available in all RAL colours under request. Please send us your enquiry. Couleurs spéciales disponibles dans toute gamme de coloris RAL, sur demande.



Apto para uso alimentario. Registro sanitario nº 3904321/V Food Graded. Health registration nº 3904321/V Apte pour l'utilisation alimentaire. Registre sanitaire nº 3904321/V



Eficiencia logística Logistic efficiency Efficacité logistique



52P



53P

MODELO Model / Modèle	52P	53P
CÓDIGO Code / Code	● 202025 ⊖ 202346	● 203022 ⊖ 203343
MEDIDAS Sizes / Mesures	236 x 160 x 130 mm	336 x 160 x 130 mm
CONTIENE Contained / Contient	1 Kit = 5 Gavetas flejadas 1 Kit = 5 Strapped bin boxes 1 Set = 5 Bacs à bec dépliés	1 Kit = 5 Gavetas flejadas 1 Kit = 5 Strapped bin boxes 1 Set = 5 Bacs à bec dépliés
MATERIAL Material / Matériau	PP	PP
EMBALAJE / UNIDADES Packing / Units Emballage / Unités	8 Kits = 40 U	8 Kits = 40 U

Cajas de herramientas y estuches
Tool boxes and organizers
Boîtes à outils et coffrets

Productos de ordenación
Arrangement products
Produits de rangement

Tayg Car
Tayg Car
Tayg Car

Colección hogar
Home collection
Boîtes de rangement Home

Eco Tayg
Eco Tayg
Eco Tayg

Tayg Light
Tayg Light
Tayg Light

Tayg Build
Tayg Build
Tayg Build

Lista de packing
Packing list
Liste d'emballage



TABLA RESISTENCIA A LA COMPRESIÓN

Compression strength table / Tableau de résistance à la compression

PRODUCTOS PÁGINA 50 / Page 50 products / Produits page 50

GAVETA APILABLE Stackable drawer Bac à bec empilable	ENSAYO A COMPRESIÓN (HASTA LÍMITE DE DEFLEXIÓN 3 mm) Compression test (up to deflection limit of 3 mm) Test de compression (jusqu'à la flèche maximale 3mm)		ENSAYO A COMPRESIÓN (HASTA DEFLEXIÓN MÁXIMA) Compression test (up to maximum deflection limit) Test de compression (jusqu'à la déviation maximale)		ENSAYO A COMPRESIÓN (CON 6 GAVETAS APILADAS) Compression test (with 6 stackable drawers) Test de compression (avec 6 bac à bec empilés)		
	(kg) Resistencia Strenght / Résistance	(mm) Deformación Deformation Déformation	(kg) Resistencia Strenght / Résistance	(mm) Deformación Deformation Déformation	(kg) Resistencia Strenght / Résistance	(mm) Deformación Deformation Déformation	
	251023	GAVETA 51 az	506	2.4	506	2.4	345
252020	GAVETA 52 az	1172	3	1172	3.5	549	16.1
253027	GAVETA 53 az	1179	3	1163	3	506	21.7
254024	GAVETA 54 az	1247	3	1233	3	545	25.2
255021	GAVETA 55 az	1116	3	1446	5.5	570	45.9
258022	GAVETA 58 az	1163	3	1982	6.8	833	57.7
259029	GAVETA 59 az	797	3	1487	5	643	32.7
260025	GAVETA 60 az	1694	3	2833	6.5	1356	48.3

PRODUCTOS PÁGINA 52 / Page 52 products / Produits page 52

GAVETA PLEGABLE Y APILABLE. CONDICIÓN: A 40°C. Foldable and stackable drawer conditions: to 40°C Bac à bec pliable et empilable condition : A 40°C	ENSAYO A COMPRESIÓN (HASTA LÍMITE DE DEFLEXIÓN 3 mm) Compression test (up to deflection limit of 3 mm) Test de compression (jusqu'à la flèche maximale 3mm)		ENSAYO A COMPRESIÓN (HASTA DEFLEXIÓN MÁXIMA) Compression test (up to maximum deflection limit) Test de compression (jusqu'à la déviation maximale)		ENSAYO A COMPRESIÓN (CON 6 GAVETAS APILADAS) Compression test (with 6 stackable drawers) Test de compression (avec 6 bac à bec empilés)		
	(kg) Resistencia Strenght Résistance	(mm) Deformación Deformation Déformation	(kg) Resistencia Strenght Résistance	(mm) Deformación Deformation Déformation	(kg) Resistencia Strenght Résistance	(mm) Deformación Deformation Déformation	
	204029	GAVETA 54P az	355	3	382	3.7	332
204340	GAVETA 54P trans	311	3	340	4.0	288	23.6
206023	GAVETA 56P az	422	3	457	3.8	405	22.9
206344	GAVETA 56P trans	361	3	398	4.0	348	23.2
209024	GAVETA 59P az	616	3	655	4.2	469	19.5
209345	GAVETA 59P trans	482	3	548	4.6	382	20.9
210020	GAVETA 60P az	530	3	605	4.9	432	19.7
210341	GAVETA 60P trans	434	3	524	5.2	382	17.7

GAVETA PLEGABLE Y APILABLE. CONDICIÓN: A -18°C. Foldable and stackable drawer conditions: to -18°C Bac à bec pliable et empilable condition : A -18°C	ENSAYO A COMPRESIÓN (HASTA LÍMITE DE DEFLEXIÓN 3 mm) Compression test (up to deflection limit of 3 mm) Test de compression (jusqu'à la flèche maximale 3mm)		ENSAYO A COMPRESIÓN (HASTA DEFLEXIÓN MÁXIMA) Compression test (up to maximum deflection limit) Test de compression (jusqu'à la déviation maximale)		ENSAYO A COMPRESIÓN (CON 6 GAVETAS APILADAS) Compression test (with 6 stackable drawers) Test de compression (avec 6 bac à bec empilés)		
	(kg) Resistencia Strenght Résistance	(mm) Deformación Deformation Déformation	(kg) Resistencia Strenght Résistance	(mm) Deformación Deformation Déformation	(kg) Resistencia Strenght Résistance	(mm) Deformación Deformation Déformation	
	204029	GAVETA 54P az	701	3	722	3.6	602
204340	GAVETA 54P trans	701	3	725	3.7	540	18
206023	GAVETA 56P az	897	3	956	3.6	599	10.5
206344	GAVETA 56P trans	889	3	948	3.6	545	13.0
209024	GAVETA 59P az	1253	3	1269	3.4	989	19.2
209345	GAVETA 59P trans	1204	3	1246	3.8	953	22.4
210020	GAVETA 60P az	1199	3	1286	4.1	939	20.2
210341	GAVETA 60P trans	1067	3	1164	4.3	756	19.8

*Tabla correspondiente a valores típicos, según informe de ensayo AT-0042/02 de AIMPLAS, realizado en los laboratorios del Departamento de logística, embalaje y transporte de mercancías de AIDIMA (Parque Tecnológico-Paterna). / Table corresponding to typical values, according to the AIMPLAS AT-0042/02 test, performed in laboratories of the AIDIMA Merchandise Logistics, Packaging and Shipping Department (Technology Park-Paterna). / Tableau correspondant aux valeurs typiques, selon rapport de situation AIMPLAS AT-0042/02 de AIDIMA, réalisé dans les laboratoires du département de logistique, emballage et transport de marchandises



5040
Contenedor apilable encajable
Stackable cabinet
Bac empilable emboitable

Mod.

Mod.

Kit Colgar G-51
Hamging kit G-51
Kit a accrocher G-51

MODELO Model / Modèle	
CÓDIGO Code / Code	● 268021 ● 268069 ● 268106 ⊙ 268342
MEDIDAS Sizes / Mesures	395 x 500 x 320 mm
CAPACIDAD (LITROS) Capacity (Litres) Capacité (Litres)	50
MATERIAL Material / Matériau	PP
EMBALAJE / UNIDADES Packing / Units Emballage / Unités	7

MODELO Model / Modèle	Kit Colgar G-50 Hanging kit G-50 Kit a accrocher G-50	Kit Colgar G-51 Hanging kit G-51 Kit a accrocher G-51
CÓDIGO Code / Code	250903	251900
MEDIDAS Sizes / Mesures	91 x 520 x 53 mm	170 x 520 x 80 mm
CONTIENE Contained Contient	5 Gavetas / 1 Colgador 5 Drawers / 1 Hanger 5 Bacs / 1 Rail	5 Gavetas n°51 / 1 Colgador 5 Drawers n°51 / 1 Hanger 5 Bacs n°51 / 1 Rail
MATERIAL Material / Matériau	Gaveta PP / Colgador PS Drawer PP / Hanger PS Bac PP / Rail PS	Gaveta PP / Colgador PS Drawer PP / Hanger PS Bac PP / Rail PS
EMBALAJE / UNIDADES Packing / Units Emballage / Unités	10	10

Cajas de herramientas y estuches
Tool boxes and organizers
Boîtes à outils et coffrets

Productos de ordenación
Arrangement products
Produits de rangement

Tayg Car
Tayg Car
Tayg Car

Colección hogar
Home collection
Boîtes de rangement Home

Eco Tayg
Eco Tayg
Eco Tayg

Tayg Light
Tayg Light
Tayg Light

Tayg Build
Tayg Build
Tayg Build

Lista de packing
Packing list
Liste d'emballage



EURO-CAJAS PARA ALMACÉN Y TRANSPORTE

Multi purpose Heavy Duty Boxes / Bacs emboîtables pour stockage et transport



* Colores especiales disponibles en todos los colores RAL bajo pedido. Consultar
Special colours available in all RAL colours under request. Please send us your enquiry.
Couleurs spéciales disponibles dans toute gamme de coloris RAL, sur demande.



Apto para uso alimentario.
Registro sanitario nº 3904321/V
Food Graded.Health registration nº 3904321/V
Apte pour l'utilisation alimentaire.
Registre sanitaire nº 3904321/V



Personalizable con tecnología IML
Customizable with IML technology
Personnalisable avec la technologie IML



Tecnología de RFID
RFID technology
Technologie RFID



MODELO Model / Modèle	6415	6420	6430	6440	6400
CÓDIGO Code / Code	● 261008 ○ 261299	● 262005 ○ 262296	● 263002 ○ 263293	● 264009 ○ 264290	● 299001 ○ 299292
MEDIDAS Sizes / Mesures	600 x 400 x 150 mm	600 x 400 x 200 mm	600 x 400 x 300 mm	600 x 400 x 400 mm	600 x 405 x 29 mm
CAPACIDAD (LITROS) Capacity (Litres) Capacité (Litres)	22 L.	34 L.	51 L.	69 L.	-
PESO (KG.) Weight / Poids	1,23 Kg.	1,62 Kg.	2,16 Kg.	2,74 Kg.	0,65 Kg.
MATERIAL Material / Matériau	PP	PP	PP	PP	PP
EMBALAJE / UNIDADES Packing / Units Emballage / Unités	6 Retractable / 92 Palet 6 Retractable / 92 Pallet 6 paquet d'emballage / 92 Palette	6 Retractable / 64 Palet 6 Retractable / 64 Pallet 6 paquet d'emballage / 64 Palette	6 Retractable / 48 Palet 6 Retractable / 48 Pallet 6 paquet d'emballage / 48 Palette	6 Retractable / 32 Palet 6 Retractable / 32 Pallet 6 paquet d'emballage / 32 Palette	6 Retractable 6 Retractable 6 paquet d'emballage

EURO-CAJAS CON TAPA PARA ALMACÉN Y TRANSPORTE

Multi purpose Heavy Duty Boxes with cover / Conteneurs avec couvercle pour le stockage et le transport



* Colores especiales disponibles en todos los colores RAL bajo pedido. Consultar
Special colours available in all RAL colours under request. Please send us your enquiry.
Couleurs spéciales disponibles dans toute gamme de coloris RAL, sur demande.



Apto para uso alimentario.
Registro sanitario nº 3904321/V
Food Graded.Health registration nº 3904321/V
Apte pour l'utilisation alimentaire.
Registre sanitaire nº 3904321/V



Personalizable con tecnología IML
Customizable with IML technology
Personnalisable avec la technologie IML



Tecnología de RFID
RFID technology
Technologie RFID



Uso industrial
Industrial use
Usage industriel



MODELO Model / Modèle	6424-T	6434-T	6444-T	Euroroller
CÓDIGO Code / Code	● 265006	● 266003 ● 266065	● 267000 ● 267062	267994
MEDIDAS Sizes / Mesures	600 x 400 x 240 mm	600 x 400 x 340 mm	600 x 400 x 440 mm	615 x 415 x 49mm
CAPACIDAD (LITROS) Capacity (Litres) Capacité (Litres)	39 L.	58 L.	75 L.	250 Kg
PESO (KG.) Weight / Poids	2,5 kg	3 kg	3,7 kg	3,9 kg
MATERIAL Material / Matériau	PP	PP	PP	PP reforzado PP reinforced PP renforcé
EMBALAJE / UNIDADES Packing / Units Emballage / Unités	6 Retractable / 56 Palet 6 Retractable / 56 Pallet 6 paquet d'emballage / 56 Palette	6 Retractable / 48 Palet 6 Retractable / 48 Pallet 6 paquet d'emballage / 48 Palette	6 Retractable / 32 Palet 6 Retractable / 32 Pallet 6 paquet d'emballage / 32 Palette	5 UDS / Ruedas desmontadas / Disassembled wheels / Roues démontées



ESTANTERÍAS. MÓDULO CAIRO

Shelves. Cairo model / Étagère. Cairo modèle



Mod.

Modelo doble con ruedas
Double model with wheels
Modèle double avec roues



Mod.

Modelo simple con ruedas
Simple model with wheels
Modèle simple avec roues



Mod.

Modelo serie A
Serie A model
Série Modèle A



Mod.

Modelo serie B
Serie B model
Série Modèle B



Mod.

Modelo simple sin ruedas
Simple model without wheels
Modèle simple sans roues

* Ideal para anclaje en la pared.
Ideal for wall anchoring.
Idéal pour l'ancrage au mur.



Modelo doble con ruedas (10 alturas, 2 caras)
Double model with wheels (10 heights, 2 faces)
Modèle double avec roues (10 hauteurs, 2 faces)



Modelo simple con ruedas (7 alturas, 2 caras)
Simple model with wheels (7 heights, 2 faces)
Modèle simple avec roues (7 hauteurs, 2 faces)

MODELO Model / Modèle	Modelo doble con ruedas (10 alturas, 2 caras) Double model with wheels (10 heights, 2 faces) Modèle double avec roues (10 hauteurs, 2 faces)	Modelo simple con ruedas (7 alturas, 2 caras) Simple model with wheels (7 heights, 2 faces) Modèle simple avec roues (7 hauteurs, 2 faces)
CÓDIGO Code / Code	396007	396045

MEDIDAS Sizes / Mesures	900 x 640 x 1800mm	900 x 640 x 1305mm
----------------------------	--------------------	--------------------

CONTIENE Contained Contient	9 líneas de 8 gavetas 51 = 72 gavetas = 3 cajas de 24 9 líneas de 5 gavetas 52 = 45 gavetas = 3 cajas de 15 2 líneas de 4 gavetas 55 = 8 gavetas = 1 caja de 10 (sobran 2) 9 lines 8 drawers 51 = 72 drawers = 3 boxes of 24 9 lines 5 drawers 52 = 45 drawers = 3 boxes of 15 2 lines 4 drawers 55 = 8 drawers = 1 boite en 10 (left 2) 9 lignes 8 bac 51 = 72 bac = 3 boites en 24 9 lignes 5 bac 52 = 45 bac = 3 boites en 15 2 lignes 4 bac 55 = 8 bac = 1 boite en 10 (restants 2)	6 líneas de 8 gavetas 51 = 48 gavetas = 2 cajas de 24 6 líneas de 5 gavetas 52 = 30 gavetas = 2 cajas de 15 2 líneas de 4 gavetas 55 = 8 gavetas = 1 caja de 8 6 lines 8 drawers 51 = 48 drawers = 2 boxes of 24 6 lines 5 drawers 52 = 30 drawers = 2 boxes of 15 2 lines 4 drawers 55 = 8 drawers = 1 boite en 8 6 lignes 8 bac 51 = 48 bac = 2 boites en 24 6 lignes 5 bac 52 = 30 bac = 2 boites en 15 2 lignes 4 bac 55 = 8 bac = 1 boite en 8
-----------------------------------	---	---



Modelo serie A (10 alturas, 1 cara) sin ruedas
Serie A model (10 heights, 1 face) without wheels
Série Modèle A (10 hauteurs, 1 face) sans roues



Modelo serie B (10 alturas, 1 cara) sin ruedas
Serie B model (10 heights, 1 face) without wheels
Série Modèle B (10 hauteurs, 1 face) sans roues



Modelo simple sin ruedas (7 alturas, 1 cara)
Simple model without wheels (7 heights, 1 face)
Modèle simple sans roues (7 hauteurs, 1 côté)

MODELO Model / Modèle	Modelo serie A (10 alturas, 1 cara) sin ruedas Serie A model (10 heights, 1 face) without wheels Série Modèle A (10 hauteurs, 1 face) sans roues	Modelo serie B (10 alturas, 1 cara) sin ruedas Serie B model (10 heights, 1 face) without wheels Série Modèle B (10 hauteurs, 1 face) sans roues	Modelo simple sin ruedas (7 alturas, 1 cara) Simple model without wheels (7 heights, 1 face) Modèle simple sans roues (7 hauteurs, 1 côté)
CÓDIGO Code / Code	396021	396014	396038

MEDIDAS Sizes / Mesures	900 x 400 x 1965mm	900 x 400 x 1695mm	900 x 400 x 1200mm
----------------------------	--------------------	--------------------	--------------------

CONTIENE Contained Contient	6 líneas de 8 gavetas 51 = 48 gavetas = 2 cajas de 24 3 líneas de 5 gavetas 52 = 15 gavetas = 1 caja de 15 1 línea de 4 gavetas 55 = 4 gavetas = 1 caja de 8 (sobran 4) 6 lines 8 drawers 51 = 48 drawers = 2 boxes of 24 3 lines 5 drawers 52 = 15 drawers = 1 box of 15 1 line 4 drawers 55 = 4 drawers = 1 boite en 8 (left 4) 6 lignes 8 bac 51 = 48 bac = 2 boites en 24 3 lignes 5 bac 52 = 15 bac = 1 boites en 15 1 lignes 4 bac 55 = 4 bac = 1 boite en 8 (restants 4)	3 líneas de 8 gavetas 51 = 24 gavetas = 1 caja de 24 6 líneas de 5 gavetas 52 = 30 gavetas = 2 cajas de 15 1 línea de 4 gavetas 55 = 4 gavetas = 1 caja de 8 (sobran 4) 3 lines 8 drawers 51 = 24 drawers = 1 box of 24 6 lines 5 drawers 52 = 30 drawers = 2 boxes of 15 1 lines 4 drawers 55 = 4 drawers = 1 boite en 8 (left 4) 3 lignes 8 bac 51 = 24 bac = 1 boites en 24 6 lignes 5 bac 52 = 30 bac = 2 boites en 15 1 lignes 4 bac 55 = 4 bac = 1 boite en 8 (restants 4)	3 líneas de 8 gavetas 51 = 24 gavetas = 1 caja de 24 3 líneas de 5 gavetas 52 = 15 gavetas = 1 caja de 15 1 línea de 4 gavetas 55 = 4 gavetas = 1 caja de 8 (sobran 4) 3 lines 8 drawers 51 = 24 drawers = 1 box of 24 3 lines 5 drawers 52 = 15 drawers = 1 box of 15 1 lines 4 drawers 55 = 4 drawers = 1 boite en 8 (left 4) 3 lignes 8 bac 51 = 24 bac = 1 boites en 24 3 lignes 5 bac 52 = 15 bac = 1 boites en 15 1 lignes 4 bac 55 = 4 bac = 1 boite en 8 (restants 4)
-----------------------------------	---	--	---

Cajas de herramientas y estuches
Tool boxes and organizers
Boîtes à outils et coffrets

Productos de ordenación
Arrangement products
Produits de rangement

Tayg Car
Tayg Car
Tayg Car

Colección hogar
Home collection
Boîtes de rangement Home

Eco Tayg
Eco Tayg
Eco Tayg

Tayg Light
Tayg Light
Tayg light

Tayg Build
Tayg Build
Tayg Build

Lista de packing
Packing list
Liste d'emballage



KIT ESTANTERÍA METÁLICA

Metal shelves kit / Set étagères métalliques



MODELO Model / Modèle	300	400
CÓDIGO Code / Code	398001	399008
MEDIDAS Sizes / Mesures	1030 x 337 x 2050 mm	1030 x 437 x 2050 mm
CONTIENE Contained Contient	4 Puntales / 16 Bandejas 300 / Acc. 16 Bandejas 300 4 Studs 16 Trays 300 / Acc. 16 Trays 300 4 Montants 16 Rayons 300 / Acc. 16 rayons 300	4 Puntales / 16 Bandejas 400 / Acc. 16 Bandejas 400 4 Studs 16 Trays 400 / Acc. 16 Trays 400 4 Montants 16 Rayons 400 / Acc. 16 rayons 400

MODELO
Model / Modèle

**Kit estantería 301
Shelving kit 301
Set étagères 301**

**Kit estantería 401
Shelving kit 401
Set étagères 401**

CÓDIGO Code / Code	398308	399305
-----------------------	--------	--------

MEDIDAS Sizes / Mesures	1030 x 337 x 2050 mm	1030 x 437 x 2050 mm
----------------------------	----------------------	----------------------

CONTIENE Contained Contient	1 Estantería 300 (16 Bandejas) 120 Cajones 301 18 bolsas de 20 Separadores 01 1 Shelving 300 (16 Trays) / 120 Drawers 301 / 18 bags of 20 dividers 01 1 étagères 300 (16 Rayons) / 120 Tiroirs 301 / 18 sacs 20 séparateurs 01	1 Estantería 400 (16 Bandejas) 120 Cajones 401 30 bolsas de 20 Separadores 01 1 Shelving 400 (16 Trays) / 120 Drawers 401 / 30 bags of 20 dividers 01 1 étagères 400 (16 Rayons) / 120 Tiroirs 401 / 30 sacs 20 séparateurs 01
-----------------------------------	--	--



MODELO
Model / Modèle

**Kit estantería 302
Shelving kit 302
Set étagères 302**

**Kit estantería 402
Shelving kit 402
Set étagères 402**

CÓDIGO Code / Code	398315	399312
-----------------------	--------	--------

MEDIDAS Sizes / Mesures	1030 x 337 x 2050 mm	1030 x 437 x 2050 mm
----------------------------	----------------------	----------------------

CONTIENE Contained Contient	1 estantería 300 (16 Bandejas) / 60 Cajones 302 / 18 bolsas de 10 Separadores 02 1 Shelving 300 (16 Trays) / 60 Drawers 302 / 18 bags of 10 dividers 02 1 étagères 300 (16 Rayons) / 60 Tiroirs 302 / 18 sacs 10 séparateurs 02	1 estantería 400 (16 Bandejas) / 60 Cajones 402 / 30 bolsas de 10 Separadores 02 1 Shelving 400 (16 Trays) / 60 Drawers 402 / 30 bags of 10 dividers 02 1 étagères 400 (16 Rayons) / 60 Tiroirs 402 / 30 sacs 10 séparateurs 02
-----------------------------------	---	---

CAJONES ESTANTERÍAS

Drawers for shelves / Tiroirs étagères

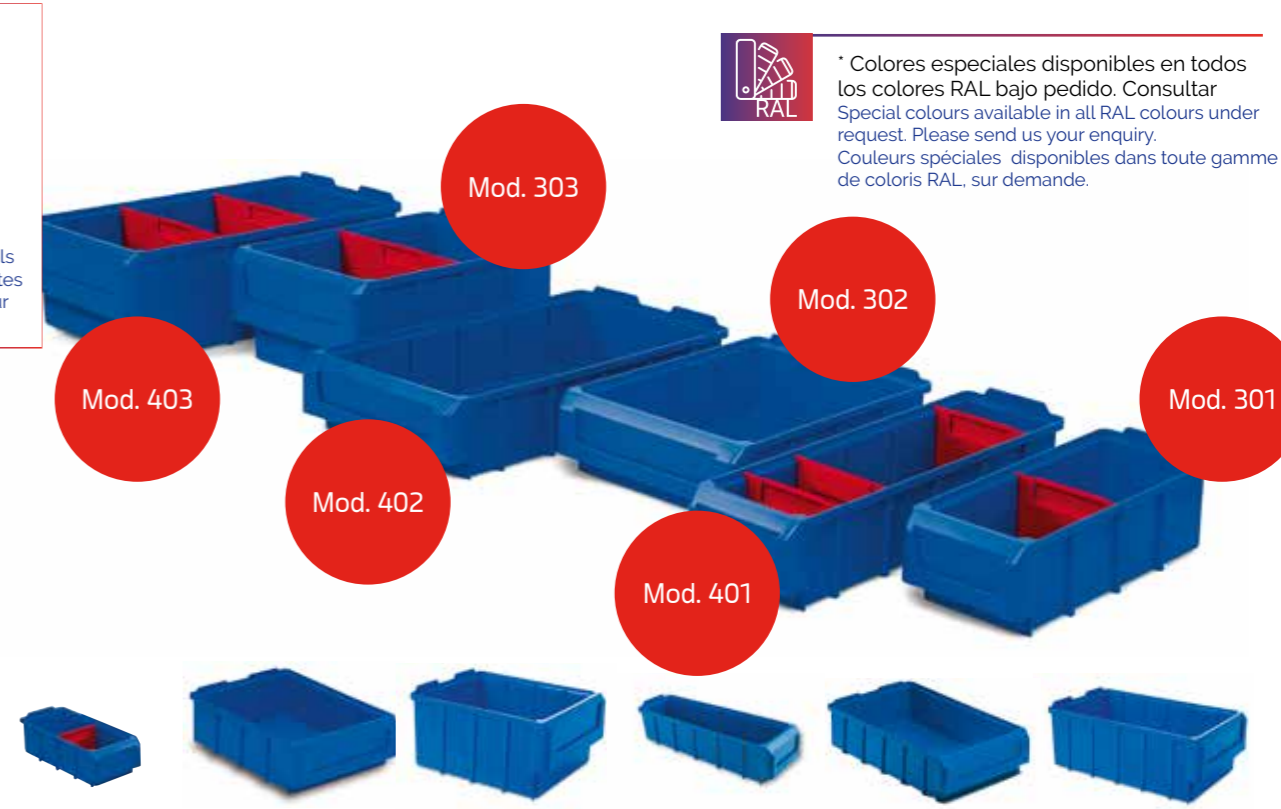

* Colores especiales disponibles en todos los colores RAL bajo pedido. Consultar Special colours available in all RAL colours under request. Please send us your enquiry. Couleurs spéciales disponibles dans toute gamme de coloris RAL, sur demande.

MODELO Model / Modèle	301	302	303	401	402	403
--------------------------	-----	-----	-----	-----	-----	-----

CÓDIGO Code / Code	355004	356001	357008	360008	361005	362002
-----------------------	--------	--------	--------	--------	--------	--------

MEDIDAS Sizes / Mesures	291 x 116 x 90 mm	291 x 232 x 90 mm	291 x 232 x 140 mm	391 x 116 x 90 mm	391 x 232 x 90 mm	391 x 232 x 140 mm
----------------------------	-------------------	-------------------	--------------------	-------------------	-------------------	--------------------

CAPACIDAD (LITROS) Capacity (Litres) Capacité (Litres)	2 L.	4.4 L.	7 L.	2.7 L.	6.1 L.	9.7 L.
--	------	--------	------	--------	--------	--------

MATERIAL Material / Matériau	Cajones PP Drawers PP Tiroirs PP	Cajones PP Drawers PP Tiroirs PP	Cajones PP Drawers PP Tiroirs PP	Cajones PP Drawers PP Tiroirs PP	Cajones PP Drawers PP Tiroirs PP	Cajones PP Drawers PP Tiroirs PP
---------------------------------	--	--	--	--	--	--

EMBALAJE / UNIDADES Packing / Units Emballage / Unités	20	10	8	20	10	8
--	----	----	---	----	----	---

MODELO Model / Modèle	01	02	03
--------------------------	----	----	----

CÓDIGO Code / Code	390005	391002	392009
-----------------------	--------	--------	--------

MEDIDAS Sizes / Mesures	103x79 mm	219x79 mm	219x129 mm
----------------------------	-----------	-----------	------------

MATERIAL Material / Matériau	PP	PP	PP
---------------------------------	----	----	----

UDS. BOLSA Units bag / Unités sac	20	10	10
--------------------------------------	----	----	----





KIT ESTANTERÍA METÁLICA CON CAJONES

Boxes with mobile dividers / Set étagère métallique avec tiroirs



Mod.

Kit estantería 303
Shelving kit 303
Set étagères 303



Mod.

Kit estantería 310
Shelving kit 310
Set étagères 310

MODELO Model / Modèle	Kit estantería 303 Shelving kit 303 Set étagères 303	Kit estantería 403 Shelving kit 403 Set étagères 403	Kit estantería 310 Shelving kit 310 Set étagères 310	Kit estantería 410 Shelving kit 410 Set étagères 410
CÓDIGO Code / Code	398322	399329	398339	399336
MEDIDAS Sizes / Mesures	1030 x 337 x 2050 mm	1030 x 437 x 2050 mm	1030 x 337 x 2050 mm	1030 x 437 x 2050 mm

CONTIENE
Contained
Contient

1 Estantería 300 (12 Bandejas) / 48 Cajones 303 / 13 Bolsas de 10 / Separadores 03
1 Shelving 300 (12 Trays) / 48 Drawers 303 / 13 Bags of 10 dividers 03
1 Étagères 300 (12 Rayons) / 48 Tiroirs 303 / 13 Sacs 10 Séparateurs 03

1 estantería 400 (12 Bandejas) / 48 Cajones 403 / 15 bolsas de 10 / Separadores 03
1 Shelving 400 (12 Trays) / 48 Drawers 403 / 15 bags of 10 dividers 03
1 Étagères 400 (12 Rayons) / 48 Tiroirs 403 / 15 Sacs 10 Séparateurs 03

1 estantería 300 / (15 Bandejas) / 40 Cajones 301 / 20 Cajones 302 / 16 Cajones 303 / 6 bolsas de 20 Separadores 01 / 6 bolsas de 10 Separadores 02 / 4 bolsas de 10 / Separadores 03
1 shelving 300 / (15Trays) / 40 Drawers 301 / 20 Drawers 302 / 16 Drawes 303 / 6 bags of 20 dividers 01 / 6 bags of 10 dividers 02 / 4 bags of 10 dividers 03
1 Étagères 300 (15 Rayons) / 40 Tiroirs 301/ 20 Tiroirs 302 / 16 Tiroirs 303 / 6 Sacs 20 Séparateurs 01 / 6 Sacs 10 Séparateurs 02 / 4 Sacs 10 / Séparateurs 03

1 estantería 400 / (15 Bandejas) / 40 Cajones 401 / 20 Cajones 402 / 16 Cajones 403 / 10 bolsas de 20 Separadores 01 / 10 bolsas de 10 Separadores 02 / 8 bolsas de 10 Separadores 03
40 Drawers 401 / 20 Drawers 402 / 16 Drawes 403 / 10 bags of 20 dividers 01 / 10 bags of 10 dividers 02 / 8 bags of 10 dividers 03
1 Étagères 400 (15 Rayons) / 40 Tiroirs 401/ 20 Tiroirs 402 / 16 Tiroirs 403 / 10 Sacs 20 Séparateurs 01 / 10 Sacs 10 Séparateurs 02 / 8 Sacs 10 / Séparateurs 03

CONTENEDORES BASCULANTES

Cabinet with tiltable drawers / Bacs basculants

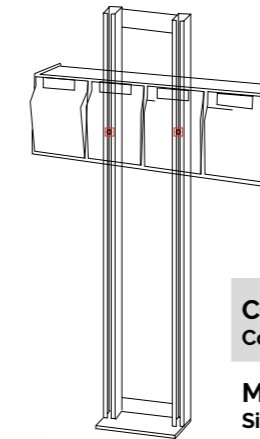

Apto para uso alimentario.
Registro sanitario nº 3904321/V
Food Graded. Health registration nº 3904321/V
Apte pour l'utilisation alimentaire.
Registre sanitaire nº 3904321/V

SOPORTE / Support / Supports

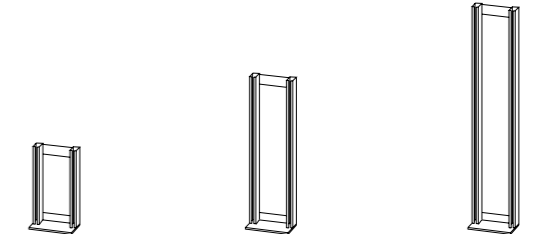

CÓDIGO Code / Code	340000	341007	342004
MEDIDAS Sizes / Mesures	60 cm	121 cm	177 cm

VARILLA CIERRE / Closing rod / Tige étroite



MODELO
Model / Modèle

Varilla cierre
Closing rod
Tige étroite

10 tornillos y arandelas
10 screws and washers
10 vis et rondelles

CÓDIGO Code / Code	343001	344008
-----------------------	--------	--------



CÓDIGO Code / Code	333606	334603	335600	336607	339608
CAJONES Drawers / Tiroirs	3	4	5	6	9
MEDIDAS Sizes / Mesures	600 x 196 x 241 mm	600 x 168 x 206 mm	600 x 133 x 165 mm	600 x 92 x 114 mm	600 x 63 x 81 mm
MATERIAL Material Matériau	PS	PS	PS	PS	PS
CONTIENE Contained Contient	No contiene tornillos Ne contient pas de vis Doesn't contain screws	No contiene tornillos Ne contient pas de vis Doesn't contain screws	No contiene tornillos Ne contient pas de vis Doesn't contain screws	No contiene tornillos Ne contient pas de vis Doesn't contain screws	No contiene tornillos Ne contient pas de vis Doesn't contain screws
EMBALAJE / UNIDADES Packing / Units Emballage / Unités	4	6	6	12	12



ESTANTERÍAS METÁLICAS

Metal shelves / Étagères métalliques



Soporta 150kg por estante
Up to 150 kg per shelf
Jusqu'à 150 kg par étagère



Montaje en 10 minutos
Assembly in 10 minutes
Assemblée en 10 minutes



Mod.
397011



Mod.
397028



MODELO
Model / Modèle

Estanteria 906 (6 niv)
Shelving 906 (6 lvl)
Étagères 906 (6 niv)

Estanteria 1205 (5 niv)
Shelving 1205 (5 lvl)
Étagères 1205 (5 niv)

Estanteria 1206 (6 niv)
Shelving 1206 (6 lvl)
Étagères 1206 (6 niv)

CÓDIGO
Code / Code

397011

397028

397035

MEDIDAS
Sizes / Mesures

900 x 450 x 2000 mm

1200 x 450 x 2000 mm

1200 x 450 x 2000 mm

CONTIENE
Contained
Contient

4 Puntales, 12 Largueros VT,
12 Largueros VLTAM,
6 Tableros aglomerados 16 mm,
4 Pies de plástico
4 Studs, 12 Transversal brackets VT, 12
Longitudinal bracket VLTAM, 6 Trays 16
mm, 4 Plastic bottoms
4 Jambes de force, 12 BarresVT,
12 Barres VLTAM,
6 Etagères en aglomeré
16mm et 4 pieds en plastique

4 Puntales, 10 Largueros VT,
10 Largueros VLTAM,
5 Tableros aglomerados 16 mm,
4 Pies de plástico
4 Studs, 10 Transversal brackets VT, 10
Longitudinal bracket VLTAM, 5 Trays 16
mm, 4 Plastic bottoms
4 Jambes de force, 10 barresVT,
10 Barres VLTAM, 5 Etagères
en aglomeré
16mm et 4 pieds en plastique

4 Puntales, 12 Largueros VT,
12 Largueros VLTAM,
6 Tableros aglomerados 16 mm,
4 Pies de plástico
4 Studs, 12 Transversal brackets VT, 12
Longitudinal bracket VLTAM, 6 Trays 16
mm, 4 Plastic bottoms
4 Jambes de force, 12 BarresVT,
12 Barres VLTAM,
6 Etagères en aglomeré
16mm et 4 pieds en plastique

KIT ESTANTERÍA METÁLICA

Metal shelves kit / Set étagères métalliques



Soporta 150kg por estante
Up to 150 kg per shelf
Jusqu'à 150 kg par étagère



Montaje en 10 minutos
Assembly in 10 minutes
Assemblée en 10 minutes



Mod.

Kit estantería 906 C
Shelving kit 906 C
Set étagères 906 C



Mod.

Kit estantería 1205 C
Shelving kit 1205 C
Set étagères 1205 C



MODELO
Model / Modèle

Kit estantería 906 C
Shelving kit 906 C
Set étagères 906 C

Kit estantería 1205 C
Shelving kit 1205 C
Set étagères 1205 C

Kit estantería 1206 C
Shelving kit 1206 C
Set étagères 1206 C

CÓDIGO
Code / Code

397042

397059

397066

MEDIDAS
Sizes / Mesures

900 x 450 x 2000 mm

1200 x 450 x 2000 mm

1200 x 450 x 2000 mm

CONTIENE
Contained
Contient

4 Puntales, 12 Largueros VT,
12 Largueros VLTAM,
6 Tableros aglomerados 16 mm, 4 Pies de
plástico, 24 gavetas nº 56, 3 Cajas
4 Studs, 12 Transversal brackets VT,
12 Longitudinal
bracket VLTAM, 6 Trays 16 mm,
4 Plastic bottoms,
24 Drawers nº 56, 3 Boxes
4 Jambes de force, 12 BarresVT,
12 Barres VLTAM,
6 Etagères en aglomeré 16mm et 4 pieds
en plastique, 24 Bacs nº 56, 3 Boites

4 Puntales, 10 Largueros VT, 10 Largueros
VLTAM,
5 Tableros aglomerados 16 mm, 4 Pies de
plástico, 24 gavetas nº 56, 4 Cajas
4 Studs, 10 Transversal brackets VT, 10
Longitudinal bracket VLTAM, 5 Trays 16
mm, 4 Plastic bottoms,
24 Drawers nº 56, 4 Boxes
4 Jambes de force, 10 barresVT, 10 Barres
VLTAM, 5 Etagères en aglomeré 16mm
et 4 pieds en plastique, 24 Bacs nº 56, 4
Boites

4 Puntales, 12 Largueros VT,
12 Largueros VLTAM,
6 Tableros aglomerados 16 mm, 4 Pies de
plástico, 32 gavetas nº 56, 4 Cajas
4 Studs, 12 Transversal brackets VT,
12 Longitudinal
bracket VLTAM, 6 Trays 16 mm, 4 Plastic
bottoms, 32 Drawers nº 56, 4 Boxes
4 Jambes de force, 12 BarresVT,
12 Barres VLTAM, 6 Etagères en aglomeré
16mm et 4 pieds en plastique,
32 Bacs nº 56, 4 Boites



KIT ESTANTERÍA PLÁSTICO

Plastic shelves kit / Set étagère plastique



* Colores especiales disponibles en todos los colores RAL bajo pedido. Consultar Special colours available in all RAL colours under request. Please send us your enquiry. Couleurs spéciales disponibles dans toute gamme de coloris RAL, sur demande.

Estanteria regulable
Adjustable shelves
Étagères réglables



Mod. 744



Mod. 634



Mod. 635



634



634



635



744

MODELO Model / Modèle	634	634	635	744	745
CÓDIGO Code / Code	228001	227004	227004	226007	225000
MEDIDAS Sizes / Mesures	600 x 300 x 1370 mm	600 x 300 x 1800 mm	600 x 300 x 1800 mm	700 x 400 x 1366 mm	700 x 400 x 1800 mm
KG PORESTANTE Kg per shelf Kg par étagère	30 Kg	30 Kg	30 Kg	40 Kg	40 Kg
CONTIENE Contained Contient	4 Bandejas, 12 Puntales, 4 Tapones, 4 Pies, 2 Soportes estanteria 4 Trays, 12 Studs, 4 Caps, 4 Feet, 2 Shelving supports 4 Rayons, 12 Montants, 4 Bouchons, 4 Pieds, 2 Supports étagère	5 Bandejas, 16 Puntales, 4 Tapones, 4 Pies, 2 Soportes estanteria 5 Trays, 16 Studs, 4 Caps, 4 Feet, 2 Shelving supports 5 Rayons, 16 Montants, 4 Bouchons, 4 Pieds, 2 Supports étagère	5 Bandejas, 16 Puntales, 4 Tapones, 4 Pies, 2 Soportes estanteria 5 Trays, 16 Studs, 4 Caps, 4 Feet, 2 Shelving supports 5 Rayons, 16 Montants, 4 Bouchons, 4 Pieds, 2 Supports étagère	4 Bandejas, 12 Puntales, 16 Casquillos reguladores, 4 Tapones, 4 Pies, 2 Soportes estanteria 4 Trays, 12 Studs, 16 Regulating bushings, 4 Caps, 4 Feet, 2 Shelving supports 4 Rayons, 12 Montants, 16 Renforts de niveau, 4 Bouchons, 4 Pieds, 2 Supports étagère	5 Bandejas, 16 Puntales, 20 Casquillos reguladores, 6 Tapones, 6 Pies, 3 Soportes estanteria 5 Trays, 16 Studs, 20 Regulating bushings, 6 Caps, 6 Feet, 3 Shelving supports 5 Rayons, 16 Montants, 20 Renforts de niveau, 6 Bouchons, 6 Pieds, 3 Supports étagère
MATERIAL Material / Matériau	Resina PP PP Resin / PP résine	Resina PP PP Resin / PP résine	Resina PP PP Resin / PP résine	Resina PP PP Resin / PP résine	Resina PP PP Resin / PP résine
EMBALAJE / UNIDADES Packing / Units Emballage / Unités	1	1	1	1	1



Mod. 945

NOVEDAD
NEW / NOUVEAUTÉ

Estanteria regulable
Adjustable shelves
Étagères réglables



Mod. 944

MODELO Model / Modèle	944	945	944 HD	945 HD
CÓDIGO Code / Code	● 221002 ● 221064 ○ 221170	● 220005 ● 220067 ○ 220173	● 221446 ● 221453	● 220449 ● 220456
MEDIDAS Sizes / Mesures	900 x 400 x 1370 mm	900 x 400 x 1800 mm	900 x 400 x 1370 mm	900 x 400 x 1800 mm
KG PORESTANTE Kg per shelf Kg par étagère	40 Kg	40 Kg	80 Kg	80 Kg
CONTIENE Contained Contient	4 Bandejas, 12 Puntales, 16 Casquillos reguladores, 4 Tapones, 4 Pies, 2 Soportes estanteria / 4 Trays, 12 Studs, 16 Regulating bushings, 4 Caps, 4 Feet, 2 Shelving supports / 4 Rayons, 12 Montants, 16 Renforts de niveau, 4 Bouchons, 4 Pieds, 2 Supports étagère	5 Bandejas, 16 Puntales, 20 Casquillos reguladores, 6 Tapones, 6 Pies, 3 Soportes estanteria / 5 Trays, 16 Studs, 20 Regulating bushings, 6 Caps, 6 Feet, 3 Shelving supports / 5 Rayons, 16 Montants, 20 Renforts de niveau, 6 Bouchons, 6 Pieds, 3 Supports étagère	4 Bandejas, 12 Puntales, 16 Casquillos reguladores, 4 Tapones, 4 Pies, 2 Soportes estanteria / 4 Trays, 12 Studs, 16 Regulating bushings, 4 Caps, 4 Feet, 2 Shelving supports / 4 Rayons, 12 Montants, 16 Renforts de niveau, 4 Bouchons, 4 Pieds, 2 Supports étagère	5 Bandejas, 16 Puntales, 20 Casquillos reguladores, 6 Tapones, 6 Pies, 3 Soportes estanteria / 5 Trays, 16 Studs, 20 Regulating bushings, 6 Caps, 6 Feet, 3 Shelving supports / 5 Rayons, 16 Montants, 20 Renforts de niveau, 6 Bouchons, 6 Pieds, 3 Supports étagère
MATERIAL Material / Matériau	Resina PP PP Resin / PP résine	Resina PP PP Resin / PP résine	Resina PP PP Resin / PP résine	Resina PP PP Resin / PP résine
EMBALAJE / UNIDADES Packing / Units Emballage / Unités	1	1	1	1



* Colores especiales disponibles en todos los colores RAL bajo pedido. Consultar Special colours available in all RAL colours under request. Please send us your enquiry. Couleurs spéciales disponibles dans toute gamme de coloris RAL, sur demande.



Montaje en 10 minutos
Assembly in 10 minutes
Assemblée en 10 minutes



No se necesitan herramientas para su montaje
No tools are needed for assembly
Aucun outil n'est nécessaire pour l'assemblage



Heavy duty. Soporta 80kg por estante
Heavy duty. Up to 80 kg per shelf
Heavy duty. Jusqu'à 80 kg par étagère



944 HD



945 HD

Cajas de herramientas y estuches
Tool boxes and organizers
Boîtes à outils et coffrets

Productos de ordenación
Arrangement products
Produits de rangement

Tayg Car
Tayg Car
Tayg Car

Colección hogar
Home collection
Boîtes de rangement Home

Eco Tayg
Eco Tayg
Eco Tayg

Tayg Light
Tayg Light
Tayg Light

Tayg Build
Tayg Build
Tayg Build

Lista de packing
Packing list
Liste d'emballage



MÓDULOS METÁLICOS

Metal stackable modules / Modules métalliques



Mod. 35/0/0

Mod. 10/2/1

MODELO Model / Modèle	35/0/0	20/2/1	10/2/1	25/0/0
CÓDIGO Code / Code	316005	315008	317002	318009
MEDIDAS Sizes / Mesures	305 x 145 x 328 mm	305 x 145 x 328 mm	305 x 145 x 237 mm	305 x 145 x 237 mm
SEPARADOR CAJONES Drawers dividers Séparateurs tiroirs	36 ud	24 ud	14 ud	26 ud
MATERIAL Material Matériau	Armazón-Chapa de acero Pintura epoxi, Cajones PP Frame-Steel sheet, Drawers PP Structure-Tôle en acier Peinture époxy, Tiroirs PP	Armazón-Chapa de acero, Pintura epoxi, Cajones PP Frame-Steel sheet, Drawers PP Structure-Tôle en acier Peinture époxy, Tiroirs PP	Armazón-Chapa de acero Pintura epoxi, Cajones PP Frame-Steel sheet, Drawers PP Structure-Tôle en acier Peinture époxy, Tiroirs PP	Armazón-Chapa de acero Pintura epoxi, Cajones PP Frame-Steel sheet, Drawers PP Structure-Tôle en acier Peinture époxy, Tiroirs PP
EMBALAJE / UNIDADES Packing / Units Emballage / Unités	4	4	4	4

CONTENEDORES CAJONES

Cabinet with drawers / Casiers à tiroirs

Etiquetas descargables en la web
Downloadable labels on the web / Étiquettes téléchargeables sur le web



Mod. 300/5



* Colores especiales disponibles en todos los colores RAL bajo pedido. Consultar Special colours available in all RAL colours under request. Please send us your enquiry. Couleurs spéciales disponibles dans toute gamme de coloris RAL, sur demande.



MODELO Model / Modèle	300/6	300/3	300/5
CÓDIGO Code / Code	350009	351006	352003
MEDIDAS EXTERIORES Outer sizes Dimensions extérieures	245 x 291 x 321 mm	245 x 291 x 321 mm	245 x 291 x 321 mm
CAJONES MEDIDAS Drawers / Sizes Tiroirs / Mesures	6 291 x 116 x 95 mm	3 291 x 232 x 95 mm	4 291 x 116 x 95 mm 1 291 x 232 x 95 mm
SEPARADOR CAJONES Drawers dividers Séparateurs tiroirs	18 separadores-01	9 separadores-02	12 separadores-01 3 separadores-02
MATERIAL Material Matériau	Armazón PS / Cajones PP Frame PS / Drawers PP Structure PS / Tiroirs PP	Armazón PS / Cajones PP Frame PS / Drawers PP Structure PS / Tiroirs PP	Armazón PS / Cajones PP Frame PS / Drawers PP Structure PS / Tiroirs PP
EMBALAJE / UNIDADES Packing / Units Emballage / Unités	2	2	2

Cajas de herramientas y estuches
Tool boxes and organizers
Boîtes à outils et coffrets

Productos de ordenación
Arrangement products
Produits de rangement

Tayg Car
Tayg Car
Tayg Car

Colección hogar
Home collection
Boîtes de rangement Home

Eco Tayg
Eco Tayg
Eco Tayg

Tayg Light
Tayg Light
Tayg Light

Tayg Build
Tayg Build
Tayg Build

Lista de packing
Packing list
Liste d'emballage



CLASIFICADORES APILABLES

Stackable classifiers unit / Racks de rangement apilables



* Colores especiales disponibles en todos los colores RAL bajo pedido. Consultar Special colours available in all RAL colours under request. Please send us your enquiry. Couleurs spéciales disponibles dans toute gamme de coloris RAL, sur demande.



Etiquetas descargables en la web
Downloadable labels on the web / Étiquettes téléchargeables sur le web



Cod. 304002



Cod. 306006



Cod. 309007



Cod. 312007

CÓDIGO Code / Code	304002	306006	309007	312007
MEDIDAS EXTERIORES Outer sizes Dimensions extérieures	360 x 170 x 190 mm	360 x 170 x 190 mm	360 x 170 x 190 mm	360 x 170 x 190 mm
GAVETAS Drawers / Bacs	4	6	9	12 separadores 12 dividers 12 Séparateurs
MEDIDAS GAVETAS Drawer sizes Dimensions bacs	160 x 170 x 80 mm	100 x 170 x 80 mm	100 x 170 x 50 mm	80 x 170 x 50 mm
MEDIDAS Sizes / Mesures	Armazón PS / Gavetas PP Frame PS / Drawers PP Structure PS / Bacs PP	Armazón PS / Gavetas PP Frame PS / Drawers PP Structure PS / Bacs PP	Armazón PS / Gavetas PP Frame PS / Drawers PP Structure PS / Bacs PP	Armazón PS / Gavetas PP Frame PS / Drawers PP Structure PS / Bacs PP
EMBALAJE / UNIDADES Packing / Units Emballage / Unités	4	4	4	4

MÓDULOS APILABLES

Stackable modules / Modules empilables



* Colores especiales disponibles en todos los colores RAL bajo pedido. Consultar Special colours available in all RAL colours under request. Please send us your enquiry. Couleurs spéciales disponibles dans toute gamme de coloris RAL, sur demande.



Etiquetas descargables en la web
Downloadable labels on the web / Étiquettes téléchargeables sur le web



Cod. 347009 - 348006

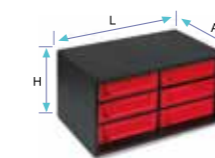

CÓDIGO Code / Code	346002	347009	348006
MEDIDAS EXTERIORES Outer sizes Dimensions extérieures	280 x 167 x 140 mm	280 x 167 x 140 mm	280 x 167 x 140 mm
CAJONES MEDIDAS Drawers / Sizes Tiroirs / Mesures	6 127 x 150 x 37 mm	3 127 x 150 x 37 mm 6 62 x 150 x 37 mm	12 62 x 150 x 37 mm
SEPARADOR CAJONES Drawers dividers Séparateurs tiroirs	6 unid.	3 unid. 6 unid.	12 unid.
MATERIAL Material Matériau	PS	PS	PS
EMBALAJE / UNIDADES Packing / Units Emballage / Unités	6	6	6

Tayg MULTIBOX

Multibox / Multibox



* Colores especiales disponibles en todos los colores RAL bajo pedido. Consultar Special colours available in all RAL colours under request. Please send us your enquiry. Couleurs spéciales disponibles dans toute gamme de coloris RAL, sur demande.



Multibox n°1

MODELO Model / Modèle	
CÓDIGO Code / Code	301001
MEDIDAS LxAxH Sizes / Mesures	335 x 250 x 275 mm
CONTIENE Contained Contient	Módulo + 4 estuches 22 + asa Module + 4 organizers 22 + handle Module + 4 coffres 22 + poignée
MATERIAL Material Matériau	PP
EMBALAJE / UNIDADES Packing / Units Emballage / Unités	2



Multibox n°2

Multibox n°3

Multibox n°2 L.

Multibox n°3 L.

MODELO Model / Modèle	Multibox n°2	Multibox n°3	Multibox n°2 L.	Multibox n°3 L.
CÓDIGO Code / Code	302008	303005	302503	303500
MEDIDAS LxAxH Sizes / Mesures	447 x 314 x 360 mm	530 x 376 x 430 mm	447 x 314 x 360 mm	530 x 376 x 430 mm
CONTIENE Contained Contient	Módulo + 4 estuches 23 Module + 4 organizers 23 Module + 4 coffres 23	Módulo + 4 estuches 24 Module + 4 organizers 24 Module + 4 coffres 24	Módulo + 4 estuches (46-26) Module + 4 organizers (46-26) Module + 4 coffres (46-26)	Módulo + 4 estuches (47-26) Module + 4 organizers (47-26) Module + 4 coffres (47-26)
MATERIAL Material Matériau	PP	PP	PP	PP
EMBALAJE / UNIDADES Packing / Units Emballage / Unités	2	1	2	1



* Colores especiales disponibles en todos los colores RAL bajo pedido. Consultar Special colours available in all RAL colours under request. Please send us your enquiry. Couleurs spéciales disponibles dans toute gamme de coloris RAL, sur demande.



Con función apilable para una mayor organización
Stackable for greater organisation
Avec fonction empilable pour une meilleure organisation

Mod. Multibox n°1

Colores. Base negra, mango amarillo.
Caja verde, tapa transparente
Colours. Black base, yellow handle.
Green case, clear lid
Couleurs. Base noire, anse jaune.
Casier vert, couvercle transparent

Multibox con 4 estuches con separadores móviles 22
Multibox with 4 organiser cases with mobile dividers 22-26
Multi-box avec 4 casiers à séparateurs amovibles 22-26



Medidas. Multi-Box
335mm (L) x 250mm (A) x 275mm (H)
Estuche 312mm (A) x 238mm (A) x 51mm (H)
Dimensions. Multi-Box 335x250x275mm
Case 312 x 238 x 51 mm
Dimensions. Multi-Box 335x250x275mm
Casier 312 x 238 x 51 mm



Con asa de seguridad antiapertura
Sturdy handle for easy transport
Avec anse résistante pour faciliter le transport

Cajas de herramientas y estuches
Tool boxes and organizers
Boîtes à outils et coffrets

Productos de ordenación
Arrangement products
Produits de rangement

Tayg Car
Tayg Car
Tayg Car

Colección hogar
Home collection
Boîtes de rangement Home

Eco Tayg
Eco Tayg
Eco Tayg

Tayg Light
Tayg Light
Tayg Light

Tayg Build
Tayg Build
Tayg Build

Lista de packing
Packing list
Liste d'emballage

TAYG CAR

Tayg Car | Tayg Car | Tayg Car



03

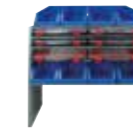

SISTEMAS DE ORDENACIÓN PARA FURGONETAS

76

Van shelving systems
Systèmes d'étagères pour utilitaires
Ordnungssystem für Transporter

Para más información escanea el código QR
For more information scan the QR
Pour plus d'informations scannez le QR
Für weitere Informationen scannen Sie die QR





SISTEMAS DE ORDENACIÓN PARA FURGONETAS

Van shelving systems / Systèmes d'étagères pour utilitaires



Diseño resistente
Robust design
Modèle résistant



Soporta 100 kg por estante
Load capacity up to 100 kg per shelf
Supporte 100 kg par étagère



Ideal para anclaje en el vehículo
Ideal for mounting on vehicle
Idéal pour fixation au véhicule



Fácil montaje
Easy to assemble
Montage facile

Ideal para anclaje en el vehículo
Ideal for mounting on vehicle
Idéal pour fixation au véhicule

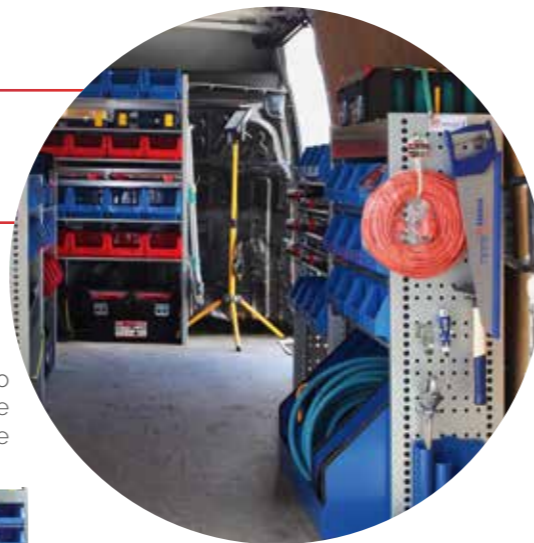

MÓDULOS

Modules / Modules



Módulo 1



Módulo 1

MODELO Model / Modèle	Módulo 1	Módulo 1
CÓDIGO Code / Code	407017	370014

MEDIDAS Sizes / Mesures	1000 x 1200 x 300	1000 x 1200 x 300
-----------------------------------	-------------------	-------------------

CONTIENE Contained Contient	1 bandeja profunda, 3 baldas gavetas 1 deep tray, 3 bin shelves / 1 plateau creux, 3 tablettes bacs à bec	1 bandeja profunda, 3 baldas gavetas, 4 gavetas modelo 55 x 3 = 12 gavetas 1 deep tray, 3 bin shelves, 4 bins model 55 x 3 = 12 bins 1 plateau creux, 3 tablettes bacs à bec à bec, 4 bacs à bec modèle 55 x 3 = 12 bacs à bec
--	--	--

EMBALAJE / UNIDADES Packing / Units Emballage / Unités	1	1
---	---	---



Módulo 2



Módulo 2

MODELO Model / Modèle	Módulo 2	Módulo 2
CÓDIGO Code / Code	407024	370021

MEDIDAS Sizes / Mesures	1000 x 1000 x 300	1000 x 1000 x 300
-----------------------------------	-------------------	-------------------

CONTIENE Contained Contient	2 baldas gavetas, 3 baldas estuches profesionales 2 bin shelves, 3 shelves for special organiser trays 2 tablettes bacs à bec, 3 tablettes coffrets professionnels	2 baldas gavetas, 3 baldas estuches profesionales, 4 gavetas 55 x 2 = 8 gavetas, 2 estuches 430/50/25 x 3 = 6 estuches / 2 bin shelves, 3 shelves for special organiser trays, 4 bins 55 x 2 = 8 bins, 2 storage trays 430/50/25 x 3 = 6 organiser trays / 2 tablettes bacs à bec, 3 tablettes coffrets professionnels, 4 bacs à bec 55 x 2 = 8 bacs à bec, 2 coffrets 430/50/25 x 3 = 6 coffrets
--	--	---

EMBALAJE / UNIDADES Packing / Units Emballage / Unités	1	1
---	---	---



Módulo 3



Módulo 3

MODELO Model / Modèle	Módulo 3	Módulo 3
CÓDIGO Code / Code	407031	370038

MEDIDAS Sizes / Mesures	980 x 1400 x 300	980 x 1400 x 300
-----------------------------------	------------------	------------------

CONTIENE Contained Contient	1 bandeja profunda, 2 baldas cajones pequeños, 2 balda cajones medianos, 2 balda cajones grandes, 8 gavetas 301 x 2 = 16 gavetas, 4 gavetas 302 x 2 = 8 gavetas, 4 gavetas 303 x 2 = 8 gavetas 1 deep tray, 2 small drawer shelves, 2 medium-size drawer shelves, 2 large drawer shelves, 8 bins 301 x 2 = 16 bins, 4 bins 302 x 2 = 8 bins, 4 bins 303 x 2 = 8 bins 1 plateau creux, 2 tablettes à petits tiroirs, 2 tablettes de tiroirs de taille moyenne, 2 tablettes grands tiroirs	1 bandeja profunda, 2 baldas cajones pequeños, 2 balda cajones medianos, 2 balda cajones grandes, 8 gavetas 301 x 2 = 16 gavetas, 4 gavetas 302 x 2 = 8 gavetas, 4 gavetas 303 x 2 = 8 gavetas 1 deep tray, 2 small drawer shelves, 2 medium-size drawer shelves, 2 large drawer shelves, 8 bins 301 x 2 = 16 bins, 4 bins 302 x 2 = 8 bins, 4 bins 303 x 2 = 8 bins 1 plateau creux, 2 tablettes à petits tiroirs, 2 tablettes de tiroirs de taille moyenne, 2 tablettes grands tiroirs, 8 bacs à bec 301 x 2 = 16 bacs à bec + 4 bacs à bec 302 x 2 = 8 bacs à bec, 4 Bacs o bec 303 x 2 = 8 bacs à bec
--	--	---

EMBALAJE / UNIDADES Packing / Units Emballage / Unités	1	1
---	---	---

ACCESORIOS METÁLICOS PARRILLA LATERAL

Metallic side-rack fittings / Accessoires métalliques grille latérale



Aro Ring
Anneau



Abrazadera con muelle
Bracket with spring
Collier de serrage à ressort



Pincho simple
Single prong
Accroche simple



Pincho doble
Double prong
Accroche double

MODELO Model / Modèle	Aro Ring Anneau	Abrazadera con muelle Bracket with spring Collier de serrage à ressort	Pincho simple Single prong Accroche simple	Pincho doble Double prong Accroche double
CÓDIGO Code / Code	370175	370182	370151	370168



Percha L
L Hanger
Cintre L



Percha XL
XL Hanger
Cintre XL



Conjunto 4 tubos
Set of 4 tubes
Ensemble de 4 tubes



Kit para cables / Mangueras enrolladas
Kit for coiled cables / Hoses
Kit pour câbles / Tuyaux enroulés

MODELO Model / Modèle	Percha L L Hanger Cintre L	Percha XL XL Hanger Cintre XL	Conjunto 4 tubos Set of 4 tubes Ensemble de 4 tubes	Kit para cables / Mangueras enrolladas Kit for coiled cables / Hoses Kit pour câbles / Tuyaux enroulés
CÓDIGO Code / Code	370137	370144	370120	370113

COLECCIÓN HOGAR

Home collection | Boîtes de rangement Home
Haushaltskollektion



COLECCIÓN HOGAR

80

Home Collection
Boîtes de rangement Home
Haushaltskollektion



04





COLECCIÓN HOGAR

Home Collection / Boîtes de rangement Home



Mod.
416590
417597



NOVEDAD
NEW / NOUVEAUTÉ

Mod.
999260



Mod. 22



Mod. 16"



MODELO
Model / Modèle

Colección hogar 30 L
Home Collection 30 L
Boîtes de rangement Home

CÓDIGO
Code / Code

● 416590
● 417597
○ 418594

MEDIDAS
Sizes / Mesures

392 x 399 x 330 mm

CAPACIDAD
Capacity / Capacité

30 L

MATERIAL
Material / Matériau

3 capas de tela, cordón de goma y puente nasal metálico
3 cloth capes, rubber cord and metallic nose bridge
3 capes en tissu, cordon en caoutchouc et pont de nez métallique

EMBALAJE / UNIDADES
Packing / Units
Emballage / Unités

5



Mascarillas higiénicas
Hygienic masks
Masques hygieniques

999260

175x95mm

40



22



23



12"



14"



16"

MODELO
Model / Modèle

CÓDIGO
Code / Code

022593 023590 110597 111594 112591

MEDIDAS
Sizes / Mesures

312 x 238 x 51 mm 388 x 290 x 61 mm 290 x 170 x 127 mm 356 x 192 x 150 mm 400 x 217 x 166 mm

CONTIENE
Contained / Contient

21 Separadores Dividers Séparateurs 21 Separadores Dividers Séparateurs Bandeja / Tray / Panier porte-outils Bandeja / Tray / Panier porte-outils Bandeja / Tray / Panier porte-outils

MATERIAL
Material / Matériau

PP PP PP PP PP

EMBALAJE / UNIDADES
Packing / Units
Emballage / Unités

6 6 10 6 6

ECO TAYG

Eco Tayg | Eco Tayg | Eco Tayg



05



CONTENEDORES RESIDUOS 50L - 60L - 80L **84**

Waste container 50L - 60L - 80L
Bacs à déchets 50L - 60L - 80L
Abfallbehälter 50L - 60L - 80L



CONTENEDORES RESIDUOS 100L - 120L **86**

Waste container 100L - 120L
Bacs à déchets 100L - 120L
Abfallbehälter 100L - 120L



CONTENEDORES RESIDUOS 120L CONTENEDOR JARDÍN 120L **88**

Waste container 120L | Garden container 120L
Bacs à déchets 120 | Poubelle de jardin pour déchets
Abfallbehälter 120L | Gartenbehälter 120L



CONTENEDORES RESIDUOS 50L - 75L - 95L **90**

Waste container 50L - 75L - 95L
Bacs à déchets 50L - 75L - 95L
Abfallbehälter 50L - 75L - 95L



BIDONES CON GRIFO | BIDONES CON CÁNULA **92**

Jerry cans with tap | Jerry cans with spout
Jerrican avec robinet | Bidons avec bec
Kanister mit Zapfhahn | Kanister mit Kanülen



CONTENEDORES RESIDUOS 50L - 60L - 80 L

Waste container 50L - 60L - 80L / Bacs à déchets 50L - 60L - 80L



* Colores especiales disponibles en todos los colores RAL bajo pedido. Consultar Special colours available in all RAL colours under request. Please send us your enquiry. Couleurs spéciales disponibles dans toute gamme de coloris RAL, sur demande.



Mod. 60P



Mod. 50P



Mod. 80



* Colores especiales disponibles en todos los colores RAL bajo pedido. Consultar Special colours available in all RAL colours under request. Please send us your enquiry. Couleurs spéciales disponibles dans toute gamme de coloris RAL, sur demande.



Personalizable
Customizable
Personnalisable



Apertura por pedal
Opens by pedal
Ouverture avec pédale



50P



60P



50P



60P

MODELO
Model / Modèle

CÓDIGO
Code / Code

● 434020	● 435027	● 430022	● 431029
● 434037	● 435034	● 430039	● 431036
○ 434068	○ 435065	○ 430008	○ 431005
● 434013	● 435010	● 430015	● 431012

MEDIDAS
Sizes / Mesures

400 x 430 x 509 mm	400 x 430 x 645 mm	400 x 430 x 509 mm	400 x 430 x 645 mm
--------------------	--------------------	--------------------	--------------------

CAPACIDAD
Capacity / Capacité

50 L	60 L	50 L	60 L
------	------	------	------

MATERIAL
Material / Matériau

PP	PP	PP	PP
----	----	----	----

EMBALAJE / UNIDADES
Packing / Units
Emballage / Unités

3	3	3	3
---	---	---	---



Mod. 80P

MODELO
Model / Modèle

CÓDIGO
Code / Code



80



80P

● 432026	● 433023
● 432033	● 433030
○ 432002	○ 433009
● 432019	● 433016

MEDIDAS
Sizes / Mesures

400 x 575 x 785 mm	400 x 575 x 785 mm
--------------------	--------------------

CAPACIDAD
Capacity / Capacité

80 L	80 L
------	------

MATERIAL
Material / Matériau

PP	PP
----	----

EMBALAJE / UNIDADES
Packing / Units
Emballage / Unités

3	3
---	---



CONTENEDORES RESIDUOS 100L - 120L

Waste container 100L - 120L / Bacs à déchets 100L - 120L



* Colores especiales disponibles en todos los colores RAL bajo pedido. Consultar
Special colours available in all RAL colours under request. Please send us your enquiry.
Couleurs spéciales disponibles dans toute gamme de coloris RAL, sur demande.



Personalizable
Customizable
Personnalisable



Mod. 100

* Ideal para uso en exteriores.
Ideal for outdoor use.
Idéal pour une utilisation en extérieur.



100

100P

MODELO Model / Modèle	100		100P	
CÓDIGO Code / Code	● 420023	● 421020	● 421037	● 421006
	● 420030	● 421037	● 421013	● 421105
	○ 420009	○ 421006	● 421013	● 421105
	● 420016	● 421013	● 421105	● 441073
	● 420108	● 421105	● 423017	● 423109
	● 440076	● 441073	● 423017	● 423109
	● 420238	● 421235	● 423017	● 423109

MEDIDAS Sizes / Mesures	600 x 568 x 770 mm	600 x 568 x 770 mm
CAPACIDAD Capacity / Capacité	100 L	100 L
MATERIAL Material / Matériau	PP	PP
EMBALAJE / UNIDADES Packing / Units Emballage / Unités	3	3



Mod. 100P

Apertura por pedal
Opens by pedal
Ouverture avec pédale

* Ideal para uso en exteriores.
Ideal for outdoor use.
Idéal pour une utilisation en extérieur.



Mod. 120



* Colores especiales disponibles en todos los colores RAL bajo pedido. Consultar
Special colours available in all RAL colours under request. Please send us your enquiry.
Couleurs spéciales disponibles dans toute gamme de coloris RAL, sur demande.



Personalizable
Customizable
Personnalisable

Asa trasera y en los laterales
Rear and side handles
Poignées derrière et sur les cotés



120

120P

MODELO Model / Modèle	120		120P	
CÓDIGO Code / Code	● 422027	● 423024	● 423031	● 423000
	● 422034	● 423031	● 423017	● 423109
	○ 422003	● 423031	● 423017	● 423109
	● 422010	● 423017	● 423017	● 423109
	● 422102	● 423109	● 423109	● 423109
	● 442070	● 423109	● 423109	● 423109
	● 422232	● 423239	● 423109	● 423109

MEDIDAS Sizes / Mesures	600 x 568 x 886 mm	600 x 568 x 886 mm
CAPACIDAD Capacity / Capacité	120 L	120 L
MATERIAL Material / Matériau	PP	PP
EMBALAJE / UNIDADES Packing / Units Emballage / Unités	3	3



Mod. 120P



CONTENEDORES RESIDUOS 120L

Waste container 120L / Garden container 120L



* Colores especiales disponibles en todos los colores RAL bajo pedido. Consultar Special colours available in all RAL colours under request. Please send us your enquiry. Couleurs spéciales disponibles dans toute gamme de coloris RAL, sur demande.



Personalizable
Customizable
Personnalisable

* Ideal para uso en exteriores.
Ideal for outdoor use.
Idéal pour une utilisation en extérieur.

*Gran estabilidad
Great stability
Grande stabilité



MODELO Model / Modèle	120 P	120 VE	120 VE-P
CÓDIGO Code / Code	● 443022 ● 443015 ○ 443008 ● 443077 ● 443237	424007	426001
MEDIDAS LxAxH Sizes / Mesures	600 x 568 x 886 mm	600 x 568 x 886 mm	600 x 568 x 886 mm
CAPACIDAD Capacity / Capacité	120 L	120 L	120 L
MATERIAL Material / Matériau	PP	PP	PP
EMBALAJE / UNIDADES Packing / Units Emballage / Unités	3	3	3

120L CONTENEDOR JARDÍN

Bacs à déchets 120L / Poubelle de jardin pour déchets



Protección contra rayos UVA
Protection against UV rays
Protection contre les rayons uva



Especial hosteleria. Enganches para bolsa 85x105mm
Special catering, hooks for bag of 85x105mm
Restauration spéciale, crochets pour sac de 85x105mm

Tapa abatible
Hinged lid
Couvercle rabattable



Contenedor de residuos
EcoTayg con 120L de capacidad
EcoTayg waste bin with 120L capacity
Conteneur à déchets EcoTayg d'une capacité de 120L

Protección contra rayos UVA
UV-A protection
Protection anti-rayons UVA

Diseño anti-vuelco
Anti-tip design
Design anti-renversement

Dispone de Asa trasera y laterales para su transporte, así como de ruedas para su fácil transporte
Rear and side handles and wheels for easy transport
Dispose de poignée arrière et de roues pour son transport facile

Medidas.
600mm (L) x 568mm (A) x 886mm (H)
Dimensions. 600x568x886mm
Dimensions. 600x568x886mm

Con pedal central para fácil apertura
With pedal for easy opening
Avec pédale centrale pour une ouverture facile



Cajas de herramientas y estuches
Tool boxes and organizers
Boîtes à outils et coffrets

Productos de ordenación
Arrangement products
Produits de rangement

Tayg Car
Tayg Car
Tayg Car

Colección hogar
Home collection
Boîtes de rangement Home

Eco Tayg
Eco Tayg
Eco Tayg

Tayg Light
Tayg Light
Tayg Light

Tayg Build
Tayg Build
Tayg Build

Lista de packing
Packing list
Liste d'emballage



CONTENEDOR RESIDUOS 50L - 75L

Waste container 50L - 75L / Bacs à déchets 50L - 75L



* Colores especiales disponibles en todos los colores RAL bajo pedido. Consultar Special colours available in all RAL colours under request. Please send us your enquiry. Couleurs spéciales disponibles dans toute gamme de coloris RAL, sur demande.



Mod. 75



50



75

MODELO

Model / Modèle

CÓDIGO

Code / Code

● 412028	● 411021
● 412035	● 411038
○ 412004	○ 411007
● 412011	● 411014
● 412103	● 411106

MEDIDAS

Sizes / Mesures

410 x 400 x 510 mm

600 x 402 x 560 mm

CONTIENE

Contained / Contient

Con cierres

With fastener / À attaches

Con cierres

With fastener / À attaches

CAPACIDAD

Capacity / Capacité

50 L

75 L

MATERIAL

Material / Matériau

PP

PP

EMBALAJE /

UNIDADES

Packing / Units

Emballage / Unités

4

4



Mod. 50

CONTENEDOR RESIDUOS 95L

Waste container 95L / Bacs à déchets 95L



* Colores especiales disponibles en todos los colores RAL bajo pedido. Consultar Special colours available in all RAL colours under request. Please send us your enquiry. Couleurs spéciales disponibles dans toute gamme de coloris RAL, sur demande.



Mod. 95



95

MODELO

Model / Modèle

CÓDIGO

Code / Code

● 410024
● 410031
○ 410000
● 410017
● 410109

MEDIDAS

Sizes / Mesures

600 x 402 x 730 mm

CONTIENE

Contained / Contient

Con cierres

With fastener / À attaches

CAPACIDAD

Capacity / Capacité

95 L

MATERIAL

Material / Matériau

PP

EMBALAJE /

UNIDADES

Packing / Units

Emballage / Unités

4



Cierre de seguridad
Safety fastener
Fermeture de sécurité



BIDONES CON GRIFO

Jerry cans with tap / Jerry cans with spout



* Colores especiales disponibles en todos los colores RAL bajo pedido. Consultar Special colours available in all RAL colours under request. Please send us your enquiry. Couleurs spéciales disponibles dans toute gamme de coloris RAL, sur demande.



Apto para uso alimentario
Food graded
Apte pour l'utilisation alimentaire



Tapón en el interior
Spout inside of the jerrycan
Bouchon inclusà l'intérieur du bidon



Cod. 610004

TAPONES Caps / Bouchons



CÓDIGO Code / Code	609008	610004	617003
-----------------------	--------	--------	--------

CAPACIDAD Capacity / Capacité	5 l. y 10 l.	20 l. y 30 l.	5 l., 10 l., 20l. y 30 l.
----------------------------------	--------------	---------------	---------------------------



CÓDIGO Code / Code	601361	602368	603365	604362
-----------------------	--------	--------	--------	--------

CAPACIDAD Capacity / Capacité	5 L	10 L	20 L	30 L
----------------------------------	-----	------	------	------

MEDIDAS Sizes / Mesures	230 x 145 x 257 mm	265 x 200 x 307 mm	345 x 234 x 377 mm	400 x 237 x 464 mm
----------------------------	--------------------	--------------------	--------------------	--------------------

MATERIAL Material / Matériau	HDPE	HDPE	HDPE	HDPE
---------------------------------	------	------	------	------

EMBALAJE / UNIDADES Packing / Units Emballage / Unités	6	6	5	5
---	---	---	---	---

BIDONES CON CÁNULA

Jerrican avec robinet / Bidons avec bec

Toma de aire para un vertido uniforme
Air intake for uniform pouring
Prise d'air pour une décharge uniforme

Cod. 602351

Presión hidráulica
200 KPa
Hydraulic pressure
Pression hydraulique



Homologados para transporte de mercancías peligrosas clases 3, 6.1, 8 y 9
Norma ADR (Transporte Internacional Carretera)
Norma RID (Transporte Internacional por Ferrocarril)
Norma IMDG (Transporte Internacional Marítimo)
Norma IATA/OACI (Transporte Internacional Aéreo)
Approved for transporting Class 3, 6.1, 8, 9 dangerous goods
ADR (International Road Transport) Regulation
RID (International Railway Transport) Regulation
IMDG (International Maritime Transport) Regulation
IATA/OACI (International Air Transport) Regulation
Homologation pour le transport de marchandises dangereuses classes 3, 6.1, 8 et 9
Norme ADR (Transport international sur Route)
Norme RID (Transport international par Train)
Norme IMDG (Transport International Maritime)
Norme IATA/OACI (Transport International Aérien)



MODELO
Model /
Modèle

CÓDIGO Code / Code	605000	606007	618000
-----------------------	--------	--------	--------

CAPACIDAD Capacity / Capacité	5 L y 10 L	20 L y 30 L	Válido para para todos los modelos de bidones
----------------------------------	------------	-------------	---



Con visor
With sight
Avec viseur

CÓDIGO Code / Code	601354	602351	603358	604355
-----------------------	--------	--------	--------	--------

CAPACIDAD Capacity / Capacité	5 L	10 L	20 L	30 L
----------------------------------	-----	------	------	------

MEDIDAS Sizes / Mesures	230 x 145 x 257 mm	265 x 200 x 307 mm	345 x 234 x 377 mm	400 x 237 x 464 mm
----------------------------	--------------------	--------------------	--------------------	--------------------

MATERIAL Material / Matériau	HDPE	HDPE	HDPE	HDPE
---------------------------------	------	------	------	------

EMBALAJE / UNIDADES Packing / Units Emballage / Unités	6	6	5	5
---	---	---	---	---



* Colores especiales disponibles en todos los colores RAL bajo pedido. Consultar Special colours available in all RAL colours under request. Please send us your enquiry. Couleurs spéciales disponibles dans toute gamme de coloris RAL, sur demande.

CLASE Class Classe	GRUPO Group Groupe	DESCRIPCIÓN Description Description	EJEMPLOS Examples / Exemple
--------------------------	--------------------------	---	--------------------------------

3	Y	INFLAMABLES	Gasolina, gasoil, otros hidrocarburos, acetona, alcoholes (metanol, etanol...) aldehidos, benceno, tolueno, xileno, éteres, ésteres, aceites, disolventes, lacas, pinturas, esmaltes, barniz... Gasoline, diesel, other hydrocarbons, acetone, alcohols (methanol, ethanol, etc.), aldehydes, benzene, toluene, xylene, ethers, esters, oils, solvents, lacquers, paints, enamels, varnish, etc. Essence, diesel, autres hydrocarbures, acétone, alcools (méthanol, éthanol...), aldéhydes, benzène, toluène, xylène, éthers, esters, huiles, solvants, laques, peintures, émaux, vernis...
---	---	-------------	---

6.1	Y	TÓXICOS TOXIC TOXIQUE	Anilinas, cloroformo, desinfectantes, plaguicidas, bencidina y compuestos de mercurio, plomo, bario, berilio, arsénio, antimonio talio, cianuro... Anilines, chloroform, disinfectants, pesticides, benzidine, and compounds of mercury, lead, barium, beryllium, arsenic, antimony, thallium, cyanide, etc. Anilines, chloroforme, désinfectants, pesticides, benzidine et composés de mercure, plomb, baryum, béryllium, arsenic, thallium antimoine, cyanure...
-----	---	-----------------------------	--

8	Y	CORROSIVOS CORROSIVE CORROSIF	Ácidos (sulfúrico, nítrico, fosfórico, acético, fórmico...) sulfumán, Hidróxidos de potasio, sosa, litio... Lejías, amoniaco, electrolitos, soluciones cáusticas... Acids (sulphuric, nitric, phosphoric, acetic, formic, etc.), hydrochloric acid Hydroxides of potassium, soda, lithium, etc. Bleaches, ammonia, electrolytes, caustic solutions, etc.
---	---	-------------------------------------	--

9	Y	VARIOS VARIOUS PLUSIEURS	Amiantos, difenilos policlorados, material líquido peligroso para el medio ambiente... Asbestos, polychlorinated biphenyl, environmentally harmful liquid material, etc. Amiante, biphényles polychlorés, matière liquide dangereuse pour l'environnement...
---	---	--------------------------------	--

TAPONES Y CÁNULAS Caps and spouts / Bouchons et canule



CÓDIGO Code / Code	607004	608001	616006
-----------------------	--------	--------	--------

CAPACIDAD Capacity / Capacité	5 L y 10 L	20 L y 30 L	5 L., 10 L., 20L y 30 L
----------------------------------	------------	-------------	-------------------------



Con visor
With sight
Avec viseur

ACCESORIOS ELÉCTRICOS

Electrical accessories | Accessoires électriques
Elektrozubehör

06



PROYECTOR LED 96

Led worklight
Projecteur led
Led strahler



PROYECTOR LED CON SOPORTE PROYECTOR LED CON TRÍPODE 98

Led worklight with stand | Led worklight with tripod
Projecteur led avec support | Projecteur led
avec trépied
Led strahler mit Ständer | Led strahler mit stativ



PROLONGADORES ELÉCTRICOS BASES MÚLTIPLES 100

Extension cables | Multiple sockets
Rallonges électriques | Prises multiples
Verlängerungskabel | Mehrfachsteckdosen



BASES MÚLTIPLES 102

Multiple sockets
Prises multiples
Mehrfachsteckdosen



LÁMPARAS LED 104

Penlight led
Lampes à led
LED-Lampen



ENROLLACABLES 106

Cable reels
Enrouleur
Kabeltrommeln



PROYECTOR LED

Led worklight / Projecteur led

LED



WATERPROOF
IP65
PROTECTION



*CÓDIGO. 520600
Display package
"tayg light"
Box pallet option
Paquet d'affichage



*CÓDIGO. 519604
Kit proyector led "tayg light" (box pallet) incluye:
Kit led worklight "tayg light" (box pallet) include:
Ensemble projecteur led "tayg light" palette
expo inclue:

- 48 LED 10W IP65 800lm
- 38 LED 20W IP65 1600lm
- 18 LED 30W IP65 2400lm
- 14 LED 50W IP65 4000lm



Ángulo de haz
Beam angle
Angle de faisceau



Sensor de movimiento
Motion sensor
Capteur de mouvement



10 - 2000 lux Luz regulable
Adjustable light
Lumière réglable



10 s - 7 min lux
Configuracion de tiempo
Time setting / Réglage de l'heure

Ángulo de haz
Beam angle
Angle de faisceau



Cod. 510601

Cod. 511608

Cod. 513602



Cod.512612

Cod.521607



MODELO Model / Modèle	10W IP65 800lm Projector led negro Led worklight black Projecteur led noir	20W IP65 1600lm Projector led negro Led worklight black Projecteur led noir	30W IP65 2400lm Projector led negro Led worklight black Projecteur led noir	50W IP65 4000lm Projector led negro Led worklight black Projecteur led noir	100W IP65 8000lm Projector led negro Led worklight black Projecteur led noir
--------------------------	---	--	--	--	---

CÓDIGO Code / Code	510601	511608	512605	513602	514609
MEDIDAS Sizes / Mesures	125 x 50 x 116 mm	150 x 50 x 138 mm	185 x 50 x 178 mm	211 x 50 x 205 mm	334 x 50 x 292 mm
POT. MÁXIMA Max Power Puissance maximale	10W - 800Lm	20W - 1600Lm	30W - 2400Lm	50W - 4000Lm	100W - 8000Lm
VOLTAJE Voltage / Tension	220-240V ~ 50-60Hz	220-240V ~ 50-60Hz	220-240V ~ 50-60Hz	220-240V ~ 50-60Hz	220-240V ~ 50-60Hz
EMBALAJE / UNIDADES Packing / Units Emballage / Unités	24	24	4	12	4

MODELO
Model / Modèle

30W IP54 2400lm
Projector led con sensor de luz y movimiento
Led worklight black with
light and motion sensor
Projecteur led avec cellule de
lumière et de mouvement

50W IP54 4000lm
Projector led con sensor de luz y
movimiento
Led worklight black with light
and motion sensor
Projecteur led avec cellule de
lumière et de mouvement

200W IP65 24000lm
Projector led negro
Led worklight black
Projecteur led noir

CÓDIGO Code / Code	512612	513619	521607
MEDIDAS Sizes / Mesures	185 x 70 x 216 mm	211 x 70 x 243 mm	400 x 91 x 320 mm
POT. MÁXIMA Max Power Puissance maximale	30W - 2400Lm	50W - 4000lm	200W - 24000lm
VOLTAJE Voltage / Tension	220-240V ~ 50Hz	220-240V ~ 50Hz	220-240V ~ 50Hz
EMBALAJE / UNIDADES Packing / Units Emballage / Unités	12	4	3



PROYECTOR LED CON SOPORTE

Led worklight with stand / Led worklight with tripod

LED



Tiempo de trabajo. 2 Horas
Work time / Temps de travail



Recargable USB
Rechargeable usb
Rechargeable par USB



Tiempo de carga. 4-5 horas
Work charge
Tiempo de carga



Ángulo de haz
Beam angle
Angle de faisceau



Micro USB 1 m
Micro USB / Micro USB



Cod. 515606



Cod. 522604



MODELO
Model / Modèle

Proyector led 20W IP54
recargable 1400lm
Led worklight 20W IP54
rechargeable 1400lm
Projecteur led 20W IP54
rechargeable 1400lm

Proyector led 30W IP65
con soporte 2400lm
Led worklight 30W IP65
with stand 2400lm
Projecteur led 30W IP65
avec support 2400lm

Proyector led 50W IP65
con soporte 4000lm
Led worklight 50W IP65
with stand 4000lm
Projecteur led 50W IP65
avec support 4000lm

CÓDIGO Code / Code	522604	515606	516603
MEDIDAS Sizes / Mesures	174 x 126 x 234 mm	220 x 205 x 315 mm	295 x 210 x 365 mm
POT. MÁXIMA Max Power Puissance maximale	20W - 1400Lm	30W - 2400Lm	50W - 4000Lm
VOLTAJE Voltage / Tension	220-240V ~ 50Hz	220-240V ~ 50-60Hz	220-240V ~ 50-60Hz
CABLE Cable / Cable	DC 5V 2A - 1 M micro USB	H05RN-F 3G 1.0mm ² 1.5m	H05RN-F 3G 1.0mm ² 1.5m
EMBALAJE / UNIDADES Packing / Units Emballage / Unités	2	8	4

PROYECTOR LED CON TRÍPODE

Projecteur led avec support / Projecteur led avec trépied

LED



Cod. 517600



Cod. 518607

MODELO
Model / Modèle

Proyector led 50W IP65
con trípode 4000lm
Led worklight 50W IP65
with tripod 4000lm
Projecteur led 50W IP65
avec trépied 4000lm

Proyector led 2x50W IP65
con trípode 8000lm
Led worklight 2x50W IP65
with tripod 8000lm
Projecteur led 2x50W IP65
avec trépied 8000lm

CÓDIGO Code / Code	517600	518607
MEDIDAS Sizes / Mesures	800 x 800 x 1455 mm	860 x 860 x 1925 mm
POT. MÁXIMA Max Power Puissance maximale	50W - 4000Lm	2 x 50W 8000Lm
VOLTAJE Voltage / Tension	220-240V ~ 50-60Hz	220-240V ~ 50-60Hz
CABLE Cable / Cable	H05RN-F 3G 1.0mm ² 2.5m	H05RN-F 3G 1.0mm ² 3m
EMBALAJE / UNIDADES Packing / Units Emballage / Unités	4	4



PROLONGADORES ELÉCTRICOS

Extension cables / Multiple sockets



Protección para niños
Protection for children
Protection pour enfants



*Listo para exposición
Ready to POS
Pret pour l'exposition

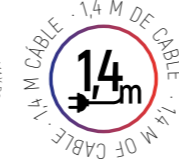
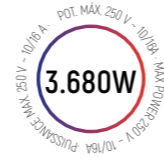
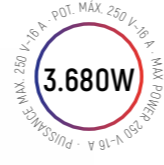

Protección para niños
Protection for children
Protection pour enfants



*Listo para exposición
Ready to POS / Pret pour l'exposition



Cod.
571008

Cod.
575006

CÓDIGO Code / Code	570001	571008	572005
POT. MÁXIMA Max Power Puissance maximale	250V~16A 3.680W	250V~16A 3.680W	250V~16A 3.680W
CLAVIJA Y BASE Plug and socket Prise + prise électrique	2P+T	2P+T	2P+T
CABLE Cable / Cable	H05VV-F 3G1,5 2 M	H05VV-F 3G1,5 3 M	H05VV-F 3G1,5 4 M
EMBALAJE / UNIDADES Packing / Units Emballage / Unités	10	10	10



CÓDIGO Code / Code	575006	576003	577000
POT. MÁXIMA Max Power Puissance maximale	250V~16A 3.680W	250V~16A 3.680W	250V~16A 3.680W
CLAVIJA Y BASE Plug and socket Prise + prise électrique	2P+T	2P+T	2P+T
CABLE Cable / Cable	H05VV-F 3G1,5 10 M	H05VV-F 3G1,5 15 M	H05VV-F 3G1,5 25 M
EMBALAJE / UNIDADES Packing / Units Emballage / Unités	6	6	6

BASES MÚLTIPLES

Rallonges électriques / Prises multiples



MODELO
Model / Modèle

3 BASES 2P + T con interruptor + 2 USB
3 sockets 2P + T with switch + 2USB
3 entrées 2P + T avec interrupteur + 2 USB

3 BASES 2P + T con interruptor
3 sockets 2P + T with switch
3 entrées 2P + T avec interrupteur

4 BASES 2P + T con interruptor
4 sockets 2P + T with switch
4 entrées 2P + T avec interrupteur

CÓDIGO Code / Code	823602	801600	806605
POT. MÁXIMA Max Power Puissance maximale	250V ~ 16A 3680W	250 V ~ 10/16A 3.680W	250 V ~ 10/16A 3.680W
CABLE Cable / Cable	H05VV-F 3G1,5 1,4M	H05VV-F 3G1,5 1,4 M	H05VV-F 3G1,5 1,4 M
EMBALAJE / UNIDADES Packing / Units Emballage / Unités	10	10	10

NOVEDAD
NEW / NOUVEAUTE



*Listo para exposición
Ready to POS
Pret pour l'exposition

MODELO
Model / Modèle

5 BASES 2P + T con interruptor
5 sockets 2P + T with switch
5 entrées 2P + T avec interrupteur

6 BASES 2P + T con interruptor
6 sockets 2P + T with switch
6 entrées 2P + T avec interrupteur

CÓDIGO Code / Code	808609	811609
POT. MÁXIMA Max Power Puissance maximale	250 V ~ 10/16A 3.680W	250 V ~ 10/16A 3.680W
CABLE Cable / Cable	H05VV-F 3G1,5 1,4 M	H05VV-F 3G1,5 1,4 M
EMBALAJE / UNIDADES Packing / Units Emballage / Unités	10	10



BASES MÚLTIPLES

Multiple sockets / Prises multiples



Protección para niños
Protection for children
Protection pour enfants

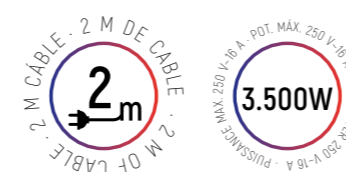

Cod.
814600

Cod. 818608

* Tienen una protección contra sobretensión. Ideal para dispositivos electrónicos.
It has an overvoltage protection. Ideal for electronic devices.
Ils ont une protection contre les surtensions. Idéal pour les appareils électroniques.



MODELO Model / Modèle	4 bases 2p + t con interruptor y protección sobre-tensión 4 sockets 2p + t with switch and voltage protection 4 entrées 2p + t avec interrupteur et parasurtenseur	6 bases 2p + t con interruptor y protección sobre-tensión 6 sockets 2p + t with switch and voltage protection 6 entrées 2p + t avec interrupteur et parasurtenseur	8 bases 2p + t con interruptor y protección sobre-tensión 8 sockets 2P + T with switch and voltage protection 8 entrées 2P + T avec interrupteur et parasurtenseur
--------------------------	--	--	--

CÓDIGO Code / Code	814600	816604	818608
POT. MÁXIMA Max Power Puissance maximale	250 V - 16A 3.500W	250 V ~ 16A 3.500W	250 V ~ 16A 3.500W
CABLE Cable / Cable	H05VV-F 3G1.5 1.5 M	H05VV-F 3G1.5 1.5 M	H05VV-F 3G1.5 1.5 M

EMBALAJE / UNIDADES Packing / Units Emballage / Unités	6	6	6
--	---	---	---



Cod.
836008



Goma neopreno
Rubber neoprene
Caoutchouc néoprène



Cod.
834004



MODELO Model / Modèle	4 bases 2P + T con tapa e interruptor 4 sockets 2P + T with cover and switch 4 entrées 2P + T avec couvercle et interrupteur	6 bases 2P + T con tapa e interruptor 6 sockets 2P + T with cover and switch 6 entrées 2P + T avec couvercle et interrupteur
--------------------------	--	--

CÓDIGO Code / Code	834004	836008
POT. MÁXIMA Max Power Puissance maximale	250V-16A 3.500W	250V-16A 3.500W
CABLE Cable / Cable	H07RN-F 3G1.5 2m (Goma-Neopreno) H07RN-F 3G1.5 2m (Rubber-Neoprene) H07RN-F 3G1.5 2m (Caoutchouc néoprène)	H07RN-F 3G1.5 2m (Goma-Neopreno) H07RN-F 3G1.5 2m (Rubber-Neoprene) H07RN-F 3G1.5 2m (Caoutchouc néoprène)

EMBALAJE / UNIDADES Packing / Units Emballage / Unités	6	6
--	---	---

Cajas de herramientas y estuches
Tool boxes and organizers
Boîtes à outils et coffrets

Productos de ordenación
Tool boxes and organizers
Produits de rangement

Tayg Car
Tayg Car
Tayg Car

Colección hogar
Home collection
Boîtes de rangement Home

Eco Tayg
Eco Tayg
Eco Tayg

Tayg Light
Tayg Light
Tayg Light

Tayg Build
Tayg Build
Tayg Build

Lista de packing
Packing list
Liste d'emballage



LÁMPARAS LED

Penlight led / Lampes à led



Carga usb
USB charge
Recharge usb



Imán y gancho en la parte inferior
Hook & Magnet on the bottom
Crochet et aimant de fond



Luz frontal
Head light
Lampe frontale



Imán en la parte superior
Magnet on the top
Aimant sur le dessus



Base retráctil / pinza
Retractable base/clamp
Base rétractable / pince



Cod.
504600



180o Rotación
180o Rotate
180o Rotation

Cod.
505607



Cod.
506604

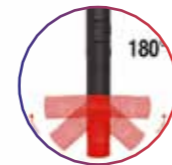

180o Rotación
180o Rotate
180o Rotation



Imán en la parte inferior
Magnet on the bottom
Aimant de fond



Luz LED en parte superior
Led light on the top
Lampe led sur le dessus



Cabezal linterna
Flashlight head
Tête de lampe de poche



Puerto micro USB
Micro USB Port
Port micro usb



Cuello de cisne flexible
Flexible gooseneck head
Col de cygne flexible

Cabezal trabajo led
Worklight head
Tête de lampe de travail

Cod. 507601



MODELO
Model / Modèle

Linterna frontal multifuncional
Multifunctional head lamp
Lampe frontale multifonctionnelle

Led trabajo multifunción X5
Multifunction led worklight X5
Lampe de travail led multifunction X5

MODELO
Model / Modèle

Lámpara de trabajo portátil
Led work and flash light
Lampe de travail portable

Led 3 en 1 Kit de luz recargable
3 in 1 Led rechargeable light kit
Kit d'éclairage rechargeable 3 en 1 led

CÓDIGO Code / Code	504600	505607
-----------------------	--------	--------

POT. MÁXIMA Max Power Puissance maximale	150 LM	180 LM
--	--------	--------

EMBALAJE / UNIDADES Packing / Units Emballage / Unités	6	6
--	---	---

CÓDIGO Code / Code	506604	507601
-----------------------	--------	--------

POT. MÁXIMA Max Power Puissance maximale	COB 110 LM	380 LM
--	------------	--------

EMBALAJE / UNIDADES Packing / Units Emballage / Unités	6	6
--	---	---



ENROLLACABLES

Cable reels / Enrouleur



* Colores especiales disponibles en todos los colores RAL bajo pedido. Consultar Special colours available in all RAL colours under request. Please send us your enquiry. Couleurs spéciales disponibles dans toute gamme de coloris RAL, sur demande.



Eficiencia logística
Logistic efficiency
Efficacité logistique

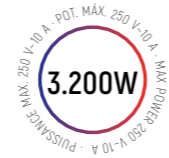

IP 20
PROTECTION

IP 20
PROTECTION



* Colores especiales disponibles en todos los colores RAL bajo pedido. Consultar Special colours available in all RAL colours under request. Please send us your enquiry. Couleurs spéciales disponibles dans toute gamme de coloris RAL, sur demande.



Eficiencia logística
Logistic efficiency
Efficacité logistique



Mod.
734601

Carrete de plástico
Plastic spool
Bobine en plastique



Mod.
749605

Soporte metálico
Metal bracket
Support en métalique



* Taller-industrias
Workshop-industry
Atelier industries

* HOGAR-BRICOLAGE
Home-DIY / Home-DIY



CÓDIGO Code / Code	714603	729607	734601
POT. MÁXIMA Max Power Puissance maximale	230 V ~ 14A 3.200W	230 V ~ 14A 3.200W	230 V ~ 14A 3.200W
BASES Sockets / Entrées	4 (2P+T) con termostato 4 (2P+T) with thermostat 4 (2P+T) avec thermostat	4 (2P+T) con termostato 4 (2P+T) with thermostat 4 (2P+T) avec thermostat	4 (2P+T) con termostato 4 (2P+T) with thermostat 4 (2P+T) avec thermostat
CABLE Cable / Cable	H05VV-F 3G1,5 5 M	H05VV-F 3G1,5 10 M	H05VV-F 3G1,5 15 M
EMBALAJE / UNIDADES Packing / Units Emballage / Unités	10	10	6

*OPCIÓN BOX PALLET
Box - pallet option
Option palette expo

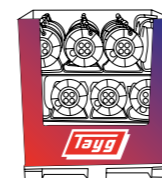

MEDIDAS BOX-PALET
box-palet sizes
Mesures palette expo

1100 x 680 x 1164 mm

CÓDIGO Code / Code	749605	772603	777608
POT. MÁXIMA Max Power Puissance maximale	250 V ~ 16A 4.000W	250 V ~ 16A 4.000W	250 V ~ 16A 4.000W
BASES Sockets / Entrées	4 (2P+T) con termostato 4 (2P+T) with thermostat 4 (2P+T) avec thermostat	4 (2P+T) con termostato 4 (2P+T) with thermostat 4 (2P+T) avec thermostat	4 (2P+T) con termostato 4 (2P+T) with thermostat 4 (2P+T) avec thermostat
CABLE Cable / Cable	H05VV-F 3G1,5 15 M	H05VV-F 3G1,5 25 M	H05VV-F 3G1,5 50 M
DIÁMETRO DE CARRETE Spool diameter Diamètre de la bobine	210 MM	210 MM	270 mm
EMBALAJE / UNIDADES Packing / Units Emballage / Unités	2	1	1



ENROLLACABLES

Cable reels / Enrouleur



Mod.
774607

Carrete de plástico
Plastic spool
Bobine en plastique

Base aérea
Air base
Base aérienne

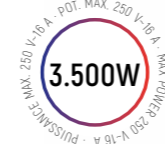

Mod.
775505



Soporte y carrete metálico
Metal spool and metal frame
Support et bobine en métallique



CÓDIGO Code / Code	774607
------------------------------	---------------

POT. MÁXIMA Max Power Puissance maximale	230 V ~ 13A 3.000W
---	--------------------

BASES Sockets / Entrées	Base aérea Air base / Base aérienne
-----------------------------------	--

CONTIENE Contained / Contient	Base aérea con termostato Air base thermostat Base aérienne avec thermostat
---	---

CABLE Cable / Cable	H05VV-F 3G1,5 25 M
-------------------------------	--------------------

DIÁMETRO DE CARRETE Spool diameter Diamètre de la bobine	240 mm
---	--------

EMBALAJE / UNIDADES Packing / Units Emballage / Unités	1
---	---

*OPCIÓN BOX PALLET
Box - pallet option
Option palette expo

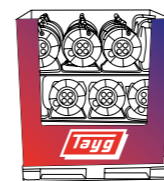

MEDIDAS BOX-PALET
box-palet sizes
Mesures palette expo

1020 x 805 x 1000mm

CÓDIGO Code / Code	770500	775505
------------------------------	---------------	---------------

POT. MÁXIMA Max Power Puissance maximale	250 V ~ 3.500W	250 V ~ 3.500W
---	----------------	----------------

BASES Sockets / Entrées	4 (2P+T) con termostato 4 (2P+T) with thermostat 4 (2P+T) avec thermostat	4 (2P+T) con termostato 4 (2P+T) with thermostat 4 (2P+T) avec thermostat
-----------------------------------	---	---

CABLE Cable / Cable	H05VV-F 3G1,5 25 M	H05VV-F 3G1,5 50 M
-------------------------------	--------------------	--------------------

DIÁMETRO DE CARRETE Spool diameter Diamètre de la bobine	255 mm	255 mm
---	--------	--------

EMBALAJE / UNIDADES Packing / Units Emballage / Unités	1	1
---	---	---



ENROLLACABLES

Cable reels / Enrouleur



* Colores especiales disponibles en todos los colores RAL bajo pedido. Consultar
Special colours available in all RAL colours under request. Please send us your enquiry.
Couleurs spéciales disponibles dans toute gamme de coloris RAL, sur demande.



Soporte metálico
Metal bracket
Support en métallique

Mod.
761607



Carrete de plástico
Plastic spool
Bobine en plastique



CÓDIGO Code / Code	761607	764608
POT. MÁXIMA Max Power Puissance maximale	230 V ~ 13A 3.000W	230 V ~ 13A 3.000W
BASES Sockets / Entrées	4 (2p+t) con termostato con tapa 4 (2p+t) with thermostat and cover 4 (2p+t) avec thermostat et couvercle	4 (2p+t) con termostato con tapa 4 (2p+t) with thermostat and cover 4 (2p+t) avec thermostat et couvercle
CABLE Cable / Cable	H05VV-F 3G1,5 25 M	H05VV-F 3G1,5 50 M
DIÁMETRO DE CARRETE Spool diameter Diamètre de la bobine	270 mm	270 mm

EMBALAJE / UNIDADES Packing / Units Emballage / Unités	1	1
---	---	---

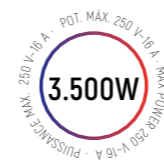

Mod.
766008



Carrete de plástico
Plastic spool
Bobine en plastique

Soporte metálico
Metal bracket
Support en métallique

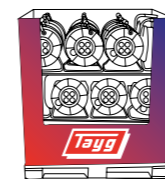

*OPCIÓN BOX PALLET
Box - pallet option
Option palette expo

CÓDIGO Code / Code	765001 / 766008
MEDIDAS BOX-PALET box-palet sizes Mesures palette expo	1122 x 805 x 1160mm



* Colores especiales disponibles en todos los colores RAL bajo pedido. Consultar
Special colours available in all RAL colours under request. Please send us your enquiry.
Couleurs spéciales disponibles dans toute gamme de coloris RAL, sur demande.

CÓDIGO Code / Code	765001	766008
POT. MÁXIMA Max Power Puissance maximale	250 V ~ 3.500W	250 V ~ 3.500W
BASES Sockets / Entrées	3 (2P+T) con termostato y tapa 3 (2P+T) with thermostat and cover 3 (2P+T) avec thermostat et couvercle	3 (2P+T) con termostato y tapa 3 (2P+T) with thermostat and cover 3 (2P+T) avec thermostat et couvercle
CABLE Cable / Cable	H05VV-F 3G1,5 25 M	H05VV-F 3G1,5 50 M
DIÁMETRO DE CARRETE Spool diameter Diamètre de la bobine	290 mm	290 mm

EMBALAJE / UNIDADES Packing / Units Emballage / Unités	1	1
---	---	---



ENROLLACABLES

Cable reels / Enrouleur

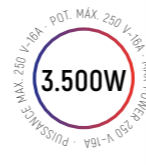

CÓDIGO Code / Code	785009	786006
POT. MÁXIMA Max Power Puissance maximale	250 V ~ 4.000W	250 V ~ 4.000W
BASES Sockets / Entrées	3 (2P+T) con termostato y tapa 3 (2P+T) with thermostat and cover 3 (2P+T) avec thermostat et couvercle	3 (2P+T) con termostato y tapa 3 (2P+T) with thermostat and cover 3 (2P+T) avec thermostat et couvercle
CABLE Cable / Cable	H05VV-F 3G2,5 25 M	H05VV-F 3G2,5 50 M
DIÁMETRO DE CARRETE Spool diameter Diamètre de la bobine	255 mm	310 mm
EMBALAJE / UNIDADES Packing / Units Emballage / Unités	1	1

Enrollacable con aplique francés
Cable reel with french connection
Enrouleur avec prise français



CÓDIGO Code / Code	785511	786518	785528	786525
POT. MÁXIMA Max Power Puissance maximale	250 V ~ 4.000W	250 V ~ 4.000W	250 V ~ 4.000W	250 V ~ 4.000W
BASES Sockets / Entrées	3 (2P+T) con termostato y tapa 3 (2P+T) with thermostat and cover 3 (2P+T) avec thermostat et couvercle	3 (2P+T) con termostato y tapa 3 (2P+T) with thermostat and cover 3 (2P+T) avec thermostat et couvercle	3 (2P+T) con termostato y tapa 3 (2P+T) with thermostat and cover 3 (2P+T) avec thermostat et couvercle	3 (2P+T) con termostato y tapa 3 (2P+T) with thermostat and cover 3 (2P+T) avec thermostat et couvercle
CABLE Cable / Cable	H05VV-F 3G2,5 25 M	H05VV-F 3G2,5 50 M	H05VV-F 3G2,5 25 M	H05VV-F 3G2,5 50 M
DIÁMETRO DE CARRETE Spool diameter Diamètre de la bobine	255 mm	310 mm	255 mm	310 mm
EMBALAJE / UNIDADES Packing / Units Emballage / Unités	1	1	1	1

* Cod. 785511 y 786518. Países homologados para uso. El aplique español: Spanish connection: / Prise espagnol: Holanda, Luxemburgo, Austria, Croacia, Suiza, Portugal, Lituania, Grecia, Chipre, Albania, Andorra, Rusia, Bielorusia, Bosnia, Bulgaria, Republica Checa, Estonia, Islas Feroe, Finlandia, Alemania, Hungría, Islandia, Lituania, Letonia, Macedonia, Mónaco, Noruega, Rumania, Eslovenia, Ucrania, Serbia, Montenegro. El aplique francés: French connection: / Prise français: Bélgica, Eslovaquia y Túnez.

Mod.
765506

Soporte y carrete metálico
Metal spool and metal frame
Support et bobine en métallique

Cable goma neopreno exteriores
Cable rubber neoprene outdoor
Cable extérieur en caoutchouc neoprene

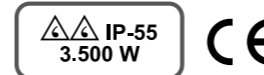

CÓDIGO Code / Code	765506	766503	795503
POT. MÁXIMA Max Power Puissance maximale	250 V ~ 3.500W	250 V ~ 3.500W	250 V ~ 4.000W
BASES Sockets / Entrées	3 (2P+T) con termostato y tapa with thermostat and cover avec thermostat et couvercle	3 (2P+T) con termostato y tapa with thermostat and cover avec thermostat et couvercle	3 (2P+T) con termostato y tapa with thermostat and cover avec thermostat et couvercle
CABLE Cable / Cable	H07RN-F 3G1,5 25 m Goma/Neopreno Rubber/Neoprene Caoutchouc/néoprène	H07RN-F 3G1,5 50 m Goma/Neopreno Rubber/Neoprene Caoutchouc/néoprène	H07RN-F 3G2,5 25 m Goma/Neopreno Rubber/Neoprene Caoutchouc/néoprène
DIÁMETRO DE CARRETE Spool diameter Diamètre de la bobine	255 mm	310 mm	255 mm
EMBALAJE / UNIDADES Packing / Units Emballage / Unités	1	1	1

*Para instaladores eléctricos: cumple con la instrucción técnica complementaria n°33 del reglamento de baja tensión.
For electrical installers: Comply with Complementary Technical Instruction no 33 of the Spanish Low Voltage Electrical Installation Regulations.
Pour les installateurs électriques: Conforme avec la norme technique n°33 du règlement de basse tension espagnol



ENROLLACABLES

Cable reels / Enrouleur

*Para instaladores eléctricos: cumple con la instrucción técnica complementaria n°33 del reglamento de baja tensión.
For electrical installers: Comply with Complementary Technical Instruction n° 33 of the Spanish Low Voltage Electrical Installation Regulations.
Pour les installateurs électriques: Conforme avec la norme technique n°33 du règlement de basse tension espagnol



Mod.
767500

Soporte metálico
Metal bracket
Support en métallique

Carrete metálico
Metal spool
Bobine en métallique

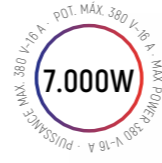
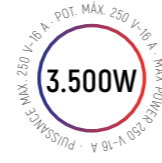

*TRIFÁSICOS
Three phase
Triphasé



Mod.
780516

Soporte y carrete metálico
Metal spool and metal frame
Support et bobine en métallique

CÓDIGO Code / Code	767500	768507
POT. MÁXIMA Max Power Puissance maximale	250 V ~ 3.500W	250 V ~ 3.500W
BASES Sockets / Entrées	2 (2P+T) con termostato y tapa 2 (2P+T) with thermostat and cover 2 (2P+T) avec thermostat et couvercle	2 (2P+T) con termostato y tapa 2 (2P+T) with thermostat and cover 2 (2P+T) avec thermostat et couvercle
CABLE Cable / Cable	H07RN-F 3G1,5 25 m Goma/Neopreno Rubber/Neoprene Caoutchouc/néoprène	H07RN-F 3G1,5 50 m Goma/Neopreno Rubber/Neoprene Caoutchouc/néoprène
DIÁMETRO DE CARRETE Spool diameter Diamètre de la bobine	255 mm	310 mm
EMBALAJE / UNIDADES Packing / Units Emballage / Unités	1	1

CÓDIGO Code / Code	760518	780516
POT. MÁXIMA Max Power Puissance maximale	380 V ~ 7.000W	380 V ~ 7.000W
BASES Sockets / Entrées	2 (3P+T6h 380V) con termostato y tapa with thermostat and cover avec thermostat et couvercle	2 (3P+T6h 380V) con termostato y tapa with thermostat and cover avec thermostat et couvercle
CABLE Cable / Cable	H05VV-F 4G1,5 25 m	H05VV-F 4G1,5 40 m
DIÁMETRO DE CARRETE Spool diameter Diamètre de la bobine	255 mm	310 mm
EMBALAJE / UNIDADES Packing / Units Emballage / Unités	1	1

ACCESORIOS PARA LA CONSTRUCCIÓN

Building accessories | Accessoires pour la construction | Bauzubehör



07



DISTANCIADORES PAVIMENTO Y SISTEMAS DE NIVELACIÓN 118

Wall and floor spacers
Espaceurs sol et mur
Fliesenabstandshalter und Nivelliersysteme



SOPORTE PAVIMENTO FLOTANTE 126

Plots
Support de sol flottant
Stelzlager Höhenverstellbar



FACHADA, PAVÉS Y ACCESORIOS DE SEGURIDAD 134

Safety brackets | Safety accessories
Glass block spacer | Accessoires de sécurité
Fassaden- und Sicherheitszubehör



ACCESORIOS PARA ENCOFRADO 140

Formwork accessories
Accessoires pour coffrage
Zubehör für Schalungen

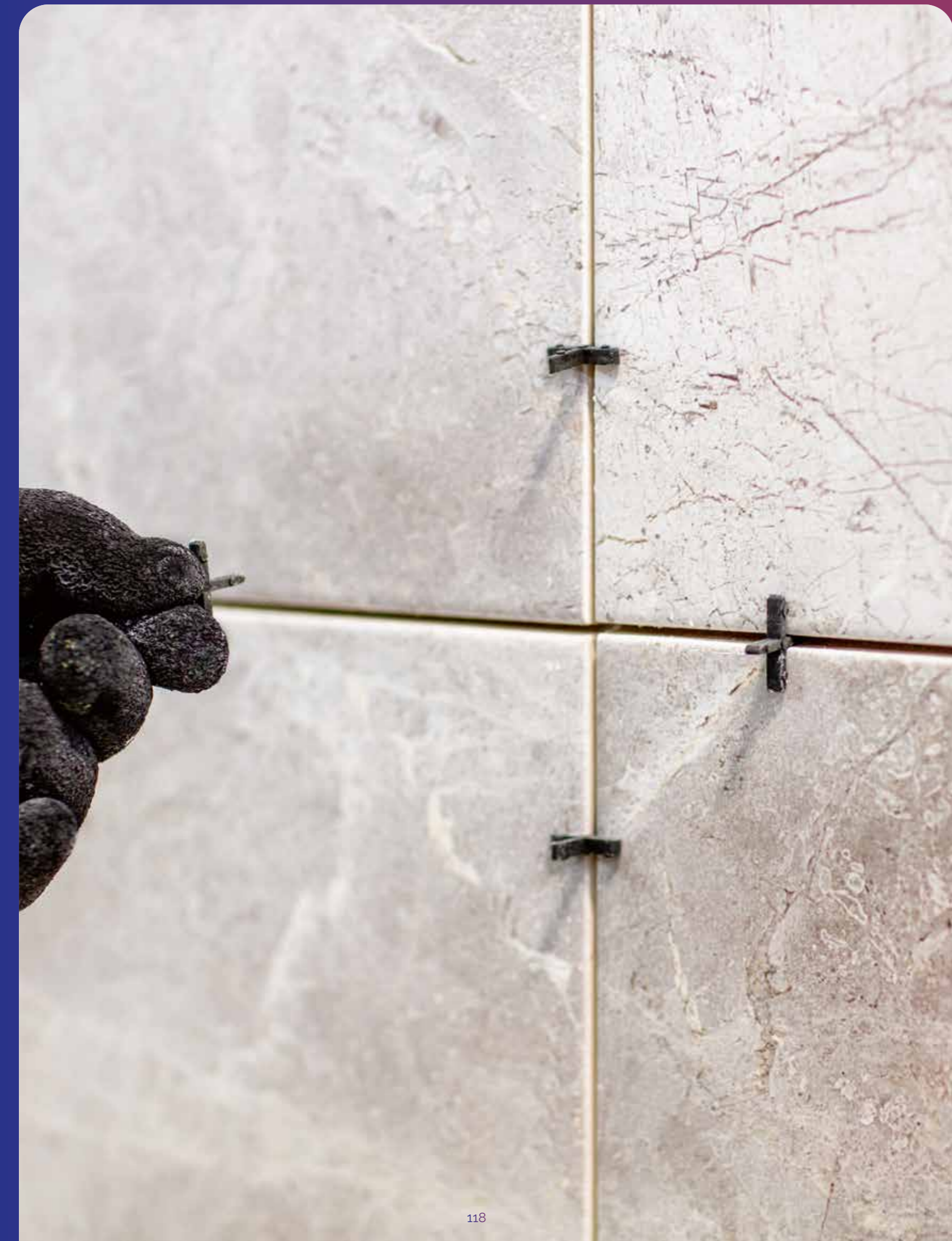

DISTANCIADORES PAVIMENTO Y REVESTIMIENTO

Wall and floor spacers
Espaceurs sol et mur

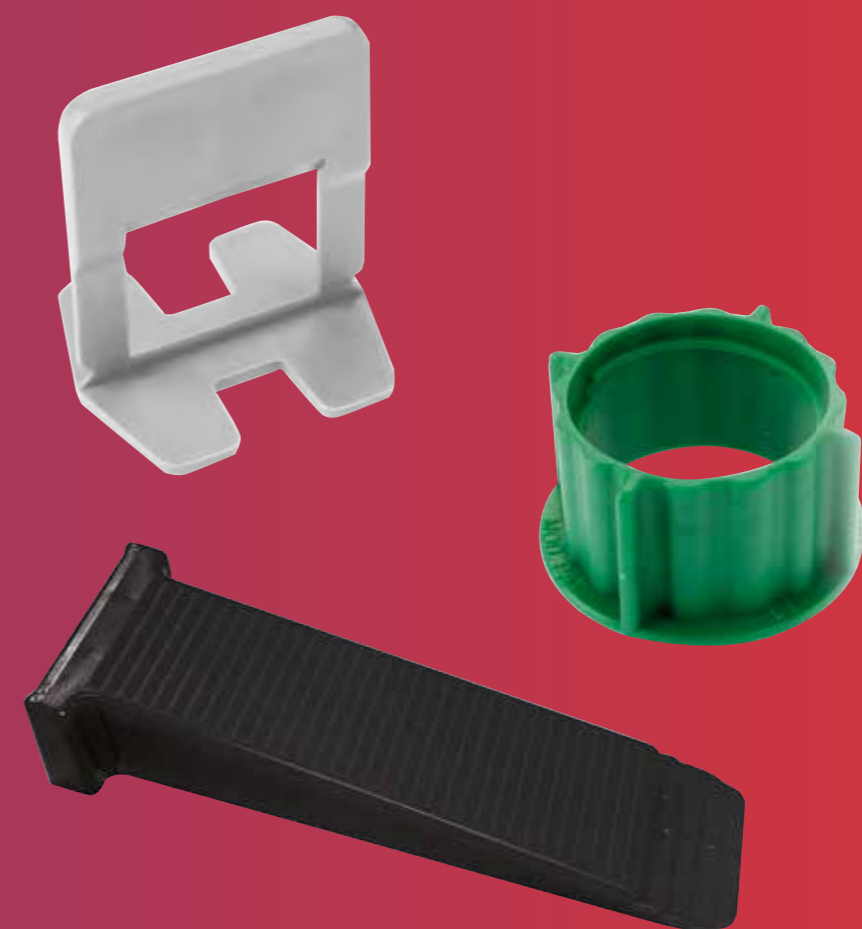

Tayg BUILD CRUCETAS

Tile spacer / Croisillons

XL Grandes formatos
Big sizes
Grand formats

T Alta resistencia
High strength
Haute resistance



*CRUCETAS EXPOSITOR
Présentoir des produits
Tile spacer exhibitor



Diseñadas para grandes formatos y de gran peso
Designed for big sizes and heavy weights
Dessinées pour des grands formats lourds

MODELO Model / Modèle	
CÓDIGO Code / Code	912009
MEDIDAS Sizes/ Mesures	1-5 mm
UDS. BOLSA Units bag Unités sac	300
UDS. CAJA Units pack Unités pack	30.000
CAJAS PALET Pack pallet Pack pallet	30

Cuña alicatado
Tile wedge
Câle pour pose



CÓDIGO Code / Code	910005	910012	910029	910036	910050	910067	910074	910081
MEDIDAS Sizes/ Mesures	1 mm - 3/64"	1.5 mm - 1/16"	2 mm - 5/64"	3 mm - 1/8"	5 mm - 13/64"	7 mm - 9/32"	10 mm - 13/32"	15 mm - 19/32"
UDS. BOLSA Units bag Unités sac	500	500	500	500	300	300	100	100
UDS. CAJA Units pack Unités pack	30.000	30.000	30.000	30.000	13.500	6.000	3.000	1.200
CAJAS PALET Pack pallet Pack pallet	30	30	20	20	20	20	20	42

KIT SISTEMA DE NIVELACIÓN

Levelling system kit / Kit système de nivellement

PROFESIONAL

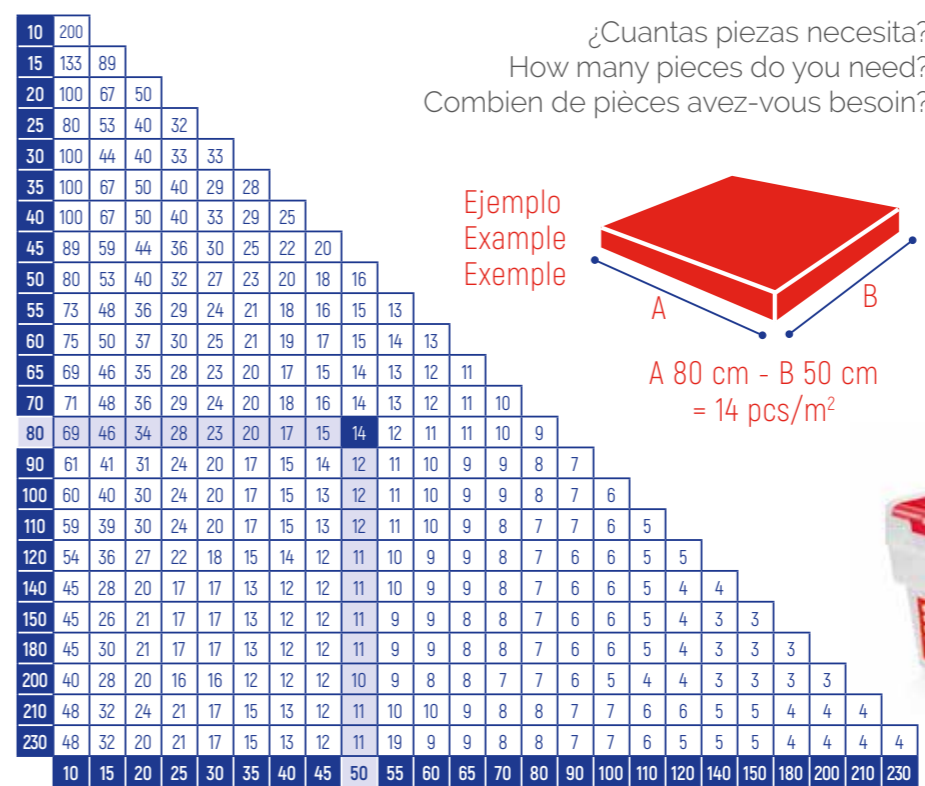

MODELO Model Modèle	Kit sistema de nivelación con cuña milimetrada ancha 1/1,5/2 mm Professional levelling system kit with millimetrated wide wedge 1/1,5/2 mm Kit système de nivellement professionnelle avec cale large millimètre 1/1,5/2 mm	Kit sistema nivel baldosas cuña ancha 1/1,5 mm Levelling system wide wedge 1/1,5 mm Kit système de nivellement cale large 1/1,5 mm	Kit sistema profesional nivel baldosas cuña ancha 1/1,5/2 mm Levelling system wide wedge 1/1,5/2 mm Kit système de nivellement cale large 1/1,5/2 mm
CÓDIGO Code / Code	913747 / 913754 / 913761	913648 / 913655	913662 / 913679 / 913686
CONTIENE Contained Contient	100 Bases, 100 Cuñas milimetradas 100 Base, 100 Millimetrated wedges, 100 Brides, 100 Câle millimètre	100 Bases, 100 Cuñas, 1 Alicate plástico 100 Base, 100 Wedges, 1 Plastic pliers 100 Brides, 100 Câle, 1 Tenaille en plastique	100 Bases, 100 Cuñas, 1 Alicate metálico 100 Base, 100 Wedges, 1 Metallic pliers 100 Brides, 100 Câle, 1 Tenaille en métallique

Tayg Build
 Tayg Build
 Tayg Build
 Tayg Light
 Tayg Light
 Tayg Light
 Eco Tayg
 Eco Tayg
 Eco Tayg
 Colección hogar
 Home collection
 Boîtes de rangement Home
 Productos de ordenación
 Arrangement products
 Produits de rangement
 Cajas de herramientas y estuches
 Tool boxes and organizers
 Boîtes à outils et coffrets
 Lista de packing
 Packing list
 Liste d'emballage



SISTEMA DE NIVELACIÓN

Levelling system / Système de nivellement



Mod.
H: 3-12 mm

Base nivelación
Levelling base
Bride nivellement



Modo de uso
Mode of use
Mode d'utilisation

H: 3-12 MM BASE NIVELACIÓN

Levelling base / Bride nivellement



NOVEDAD
NEW / NOUVEAUTÉ

MEDIDAS Sizes/ Mesures	Base 1 mm - 3/64"			Base 1,5 mm - 1/16"			Base 2 mm - 5/64"			Base 3 mm - 1/8"		
CÓDIGO Code / Code	913006	913013	913020	913914	913921	913938	913037	913044	913051	913068	913075	913082
UDS. BOLSA Units bag Unités sac	100	250	500	100	250	500	100	250	500	100	250	500
UDS. CAJA Units pack Unités pack	3000	3000	3000	3000	3000	3000	3000	3000	3000	3000	3000	3000
CAJAS PALET Pack pallet Pack pallet	20	20	20	20	20	20	20	20	20	20	20	20

H: 16-22 MM BASE ALTA (MÁRMOL / PIEDRA)

High base / Haute bride



Mod.
H: 16-22 mm

Base alta (Mármol / Piedra)
High base / Haute bride

MEDIDAS Sizes/ Mesures	Base 1 mm - 3/64"			Base 2 mm - 5/64"		
CÓDIGO Code / Code	913334	913341	913358	913365	913372	913389
UDS. BOLSA Units bag Unités sac	100	250	500	100	250	500
UDS. CAJA Units pack Unités pack	3000	3000	3000	3000	3000	3000
CAJAS PALET Pack pallet Pack pallet	16	16	16	16	16	16



Mod.
H: 3-14 mm

Base slim compatible con rosca (estrecha)
Slim base compatible with levelling thread
Slim bride compatible avec fil de nivellement

NOVEDAD
NEW / NOUVEAUTÉ

Cabeza dentada para uso con rosca
Serrated head for use with thread
Tête dentelée a utiliser avec écrou



H: 3-14 MM BASE COMPATIBLE CON ROSCA

Base compatible with levelling thread / Bride compatible avec fil de nivellement

MEDIDAS Sizes Mesures	Base 0,5 mm V - 1/51"		Base 1 mm - 3/64"		Base 1,5 mm - 1/16"		Base 2 mm - 5/64"		Base 3 mm - 1/8"						
CÓDIGO Code Code	913549	913556	913563	913211	913228	913235	913242	913259	913266	913273	913280	913297	913303	913310	913327
UDS. BOLSA Units bag Unités sac	100	250	500	100	250	500	100	250	500	100	250	500	100	250	500
UDS. CAJA Units pack Unités pack	3000	3000	3000	3000	3000	3000	3000	3000	3000	3000	3000	3000	3000	3000	3000
CAJAS PALET Pack pallet Pack pallet	16	16	16	16	16	16	16	16	16	16	16	16	16	16	16

H: 3-14 MM BASE SLIM COMPATIBLE CON ROSCA (ESTRECHA)

Slim base compatible with levelling thread / Slim bride compatible avec fil de nivellement

MEDIDAS Sizes Mesures	Base 0,5 mm V - 1/51"		Base 1 mm - 3/64"		Base 1,5 mm - 1/16"		Base 2 mm - 5/64"		Base 3 mm - 1/8"						
CÓDIGO Code Code	913518	913525	913532	913099	913105	913112	913129	913136	913143	913150	913167	913174	913181	913198	913204
UDS. BOLSA Units bag Unités sac	100	250	500	100	250	500	100	250	500	100	250	500	100	250	500
UDS. CAJA Units pack Unités pack	3000	3000	3000	3000	3000	3000	3000	3000	3000	3000	3000	3000	3000	3000	3000
CAJAS PALET Pack pallet Pack pallet	16	16	16	16	16	16	16	16	16	16	16	16	16	16	16

Cajas de herramientas y estuches
Tool boxes and organizers
Boîtes à outils et coffrets

Productos de ordenación
Arrangement products
Produits de rangement

Colección hogar
Home collection
Boîtes de rangement Home

Eco Tayg
Eco Tayg
Eco Tayg

Tayg Light
Tayg Light
Tayg light

Tayg Build
Tayg Build
Tayg Build

Lista de packing
Packing list
Liste d'emballage



ACCESORIOS DE NIVELACIÓN

Levelling system / Accessoires de mise à niveau



Mod. 913495

Rosca de nivelación. Fácil y de uso muy sencillo, pensado para ahorrar costes y tiempo. Reutilizable. Rotura perfecta y limpia, sin necesidad del uso de cuñas.

The levelling thread is a new system patented by Tayg Build, in which, we are looking for the easier and quicker installation of the tile bases, through the manual adjust by screwing, ensuring the levelling and getting the correct planimetry on the installation.

Fil de nivellement. C'est un nouveau système breveté par Tayg Build, avec lui, on recherche une installation plus commode est rapide de la céramique à Travers l'ajustement Manuel vissé qui assure le nivellement et la parfaite planimétrie de la pose.



Mod. 913587

Cuña profesional milimetrada. Apta para colocación manual. Professional measuring tip. Suitable for manual installation. Cône professionnel milimétré. Approprié pour la pose manuelle.

Modo de uso
Mode of use
Mode d'utilisation

MODO DE USO Comment utiliser / Mode of use

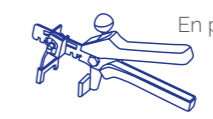

En primer lugar limpiar la superficie para una correcta colocación, además de ajustar el alicate según el espesor del material. First clean the surface for correct placement, furthermore adjust the pliers according to the thickness. Commencez par nettoyer la surface pour une pose correcte, ajuster la pince selon l'épaisseur du carrelage.



Rosca Thread Écrou



Alicate metálico* (profesional) Plastic plier Pince métallique



Alicate plástico* Metálic plier Pince plastique

MODELO
Model / Modèle

CÓDIGO Code / Code	913495	913501	913471	913488
UDS. BOLSA Units bag / Unités sac	50	100	1	1
UDS. CAJA Units pack Unités pack	1200	1200	6	6
CAJAS PALET Pack pallet Pack pallet	16	16	96	96

* Los alicates son compatibles tanto para base estrecha como para base ancha. The pliers are able to use it with wide base or slim base. Les pinces sont compatibles pour les bases étroites comme pour les bases larges.



Cuña slim (estrecha) 13 mm SLIM wedge (slim) 13 mm Cale SLIM (étroite) 13 mm



Cuña profesional milimetrada 22mm Professional measuring wedge 22mm Cale professionnelle milimétrée 22mm

MODELO
Model / Modèle

CÓDIGO Code / Code	913396	913402	913419	913570	913587	913594
UDS. BOLSA Units bag / Unités sac	100	250	500	100	250	500
UDS. CAJA Units pack Unités pack	2000	2000	2000	2000	2000	2000
CAJAS PALET Pack pallet Pack pallet	16	16	16	16	16	16



1 Colocar bases / Placer les bases / Place the base

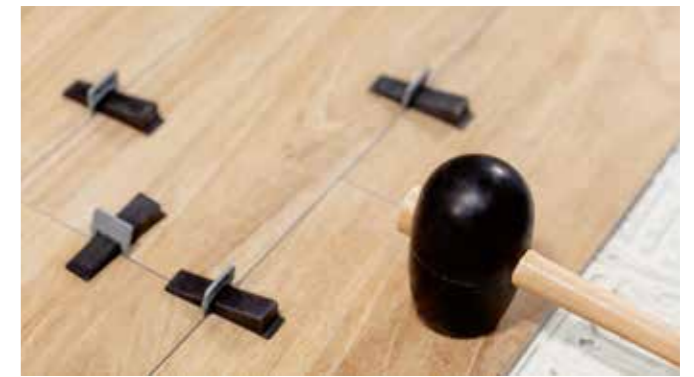

2 Macear ligeramente / Taper légèrement / Tap gently

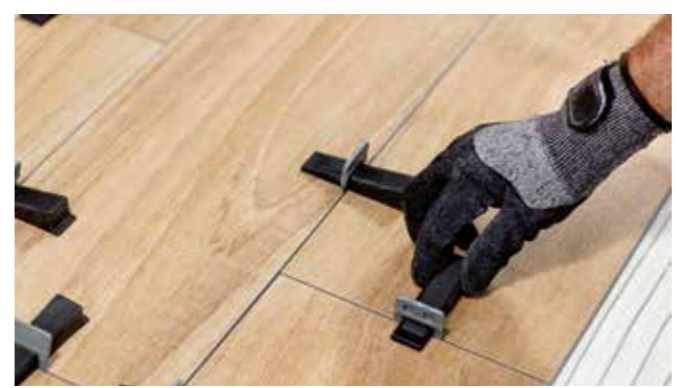

3 Introducir cuñas / Introduire les câles / Introduce the wedges



4 Apretar / Serer / Tighten

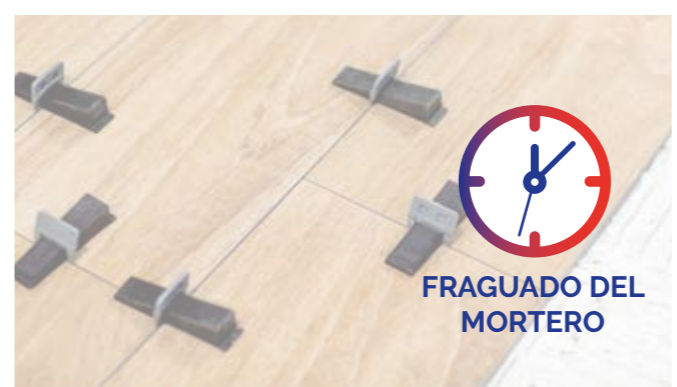

5 Esperar secado / Attendre que cela sèche / Allow for setting



6 Retirar sistema / Retirer le système / Remove the system



SOPORTE PAVIMENTO FLOTANTE

Plots
Support de sol flottant





SOPORTE PAVIMENTO FLOTANTE

Plots / Support de sol flottant

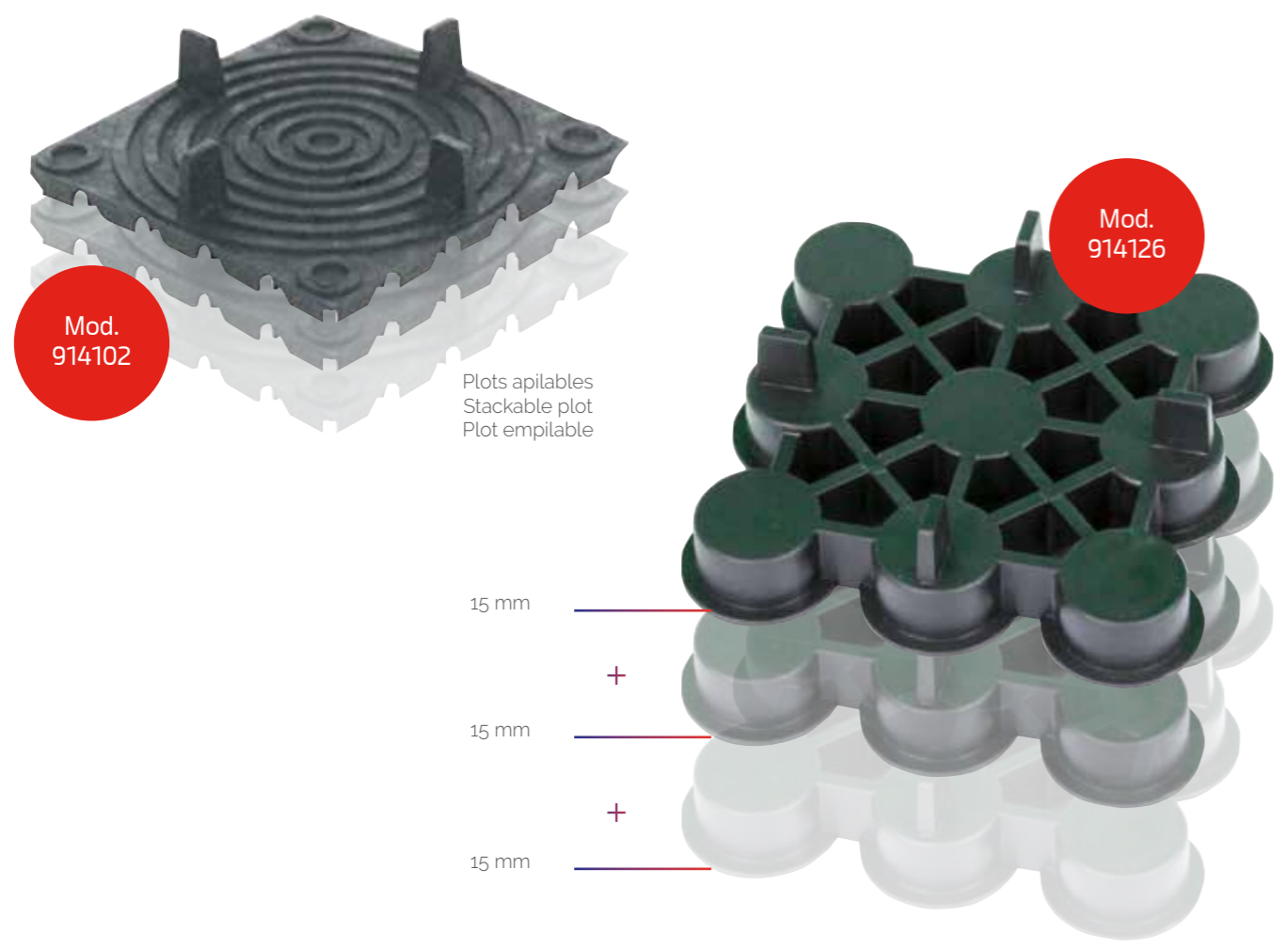

Modo de uso
Mode of use
Mode d'utilisation



Indicador de bajante
Downspout indicator
Indicateur de descente

Diferentes modelos. Desniveles: 0%, 1%, 2% para aportar inclinación y facilitar el drenaje del agua.
Different models. Unevenness: 0%, 1%, 2% to give inclination and allow water drainage. Différents modèles.
Différents modèles. Denivelés : 0%, 1%, 2% pour apporter une inclinaison et faciliter la drainage de l'eau.

TB 750

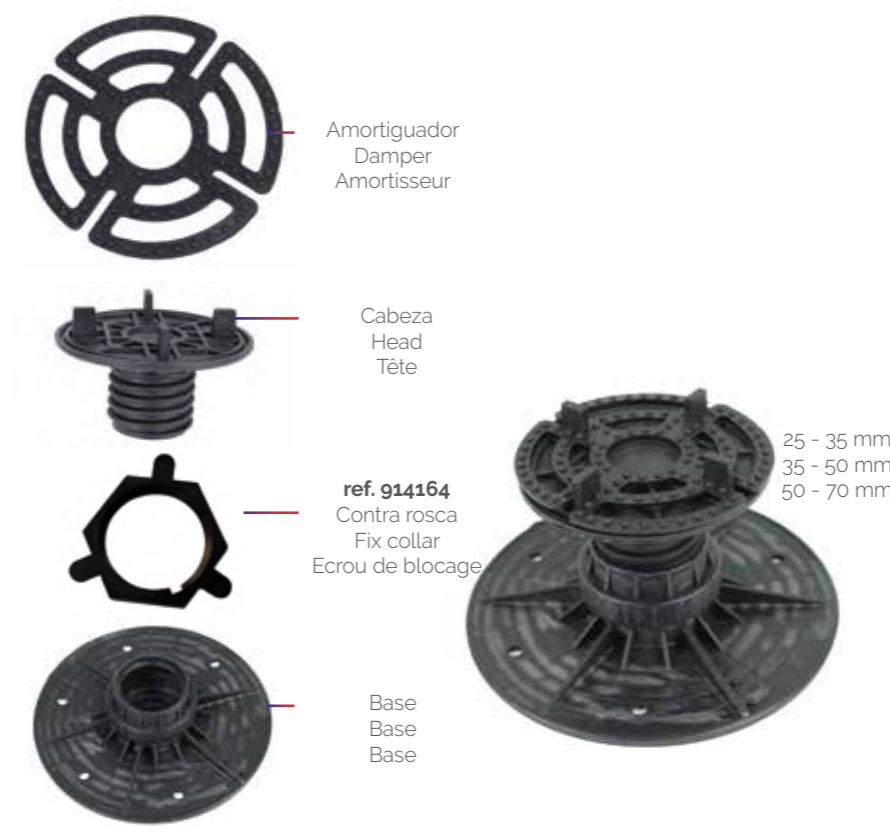

SOPORTE REGULABLE PAVIMENTO FLOTANTE

Support réglable de sol flottant / Plot



DESNIVEL Unevenness Denivelés	1%	1%	1%
--	-----------	-----------	-----------

CÓDIGO Code / Code	914140	914003	914010
------------------------------	---------------	---------------	---------------

MEDIDAS Sizes / Mesures	25-35 mm	35-50 mm	50-70 mm
-----------------------------------	----------	----------	----------

UDS. CAJA Units pack Unités pack	100	100	130
---	-----	-----	-----

CAJAS PALET Pack pallet Pack pallet	20	20	16
--	----	----	----

* Para desniveles de 0% o 2% consultar con fábrica.
For unevenness of 0% or 2% ask your commercial agent.
Pour des inégalités de 0% ou 2%, demandez à votre agent commercial.

SOPORTE PAVIMENTO FLOTANTE NO REGULABLE

Not adjustable plot / Support de sol flottant non réglable



CÓDIGO Code / Code	914102	914126	914133
MEDIDAS Sizes / Mesures	10 mm	15 mm	20 mm
ALETA Aile / Wing	3 mm	3 mm	3 mm
UDS. CAJA Units pack Unités pack	280	280	120
CAJAS PALET Pack pallet Pack pallet	20	20	20

* Base amortiguadora recomendada Ref. 914119
Recommended Damper base Ref. 914119 / Base amortissante recommandée Ref. 914119

Cajas de herramientas y estuches
Tool boxes and organizers
Boîtes à outils et coffrets

Productos de ordenación
Arrangement products
Produits de rangement

Colección hogar
Home collection
Boîtes de rangement Home

Eco Tayg
Eco Tayg
Eco Tayg

Tayg Light
Tayg Light
Tayg light

Tayg Build
Tayg Build
Tayg Build

Lista de packing
Packing list
Liste d'emballage



SOPORTE PAVIMENTO FLOTANTE

Plots / Support de sol flottant



Indicador de bajante
Downspout indicator
Indicateur de descente



65 - 100 mm
100 - 130 mm



Amortiguador
Damper
Amortisseur

Cabeza
Head
Tête

ref. 914171
Contra rosca
Fix collar
Ecrou de blocage

Rosca reguladora
Regulating thread
Ecrou régulateur

Base
Base
Base

DESNIVEL
Unevenness
Denivelés

CÓDIGO Code / Code	914041
------------------------------	---------------

MEDIDAS Sizes / Mesures	130-220 mm
-----------------------------------	------------

UDS. CAJA Units pack Unités pack	45
---	----

CAJAS PALET Pack pallet Pack pallet	16
--	----

* Para desniveles de 0% o 2% consultar con fábrica.
For unevenness of 0% or 2% ask your commercial agent.
Pour des inégalités de 0% ou 2%, demandez à votre agent commercial.



Amortiguador
Damper
Amortisseur

Cabeza
Head
Tête

ref. 914171
Contra rosca
Fix collar
Ecrou de blocage

Rosca reguladora
Regulating thread
Ecrou régulateur

Casquillo
Extender
Bague

Rosca reguladora
Regulating thread
Ecrou régulateur

Base
Base
Base

220 - 310 mm
310 - 400 mm

Indicador de bajante
Downspout indicator
Indicateur de descente

* Con 2 casquillos
With 2 extender / Avec 2 bague

DESNIVEL
Unevenness
Denivelés

CÓDIGO Code / Code	914058	914065
------------------------------	---------------	---------------

MEDIDAS Sizes / Mesures	220-310 mm	310-400 mm
-----------------------------------	------------	------------

UDS. CAJA Units pack Unités pack	35	30
---	----	----

CAJAS PALET Pack pallet Pack pallet	16	16
--	----	----

* Para desniveles de 0% o 2% consultar con fábrica. For unevenness of 0% or 2% ask your commercial agent. Pour des inégalités de 0% ou 2%, demandez à votre agent commercial.

TB 1000



DESNIVEL
Unevenness
Denivelés

1,5% 1,5%

CÓDIGO Code / Code	914027	914034
------------------------------	---------------	---------------

MEDIDAS Sizes / Mesures	65-100 mm	100-130 mm
-----------------------------------	-----------	------------

UDS. CAJA Units pack Unités pack	75	65
---	----	----

CAJAS PALET Pack pallet Pack pallet	16	16
--	----	----

* Para desniveles de 0% o 2% consultar con fábrica.
For unevenness of 0% or 2% ask your commercial agent.
Pour des inégalités de 0% ou 2%, demandez à votre agent commercial.

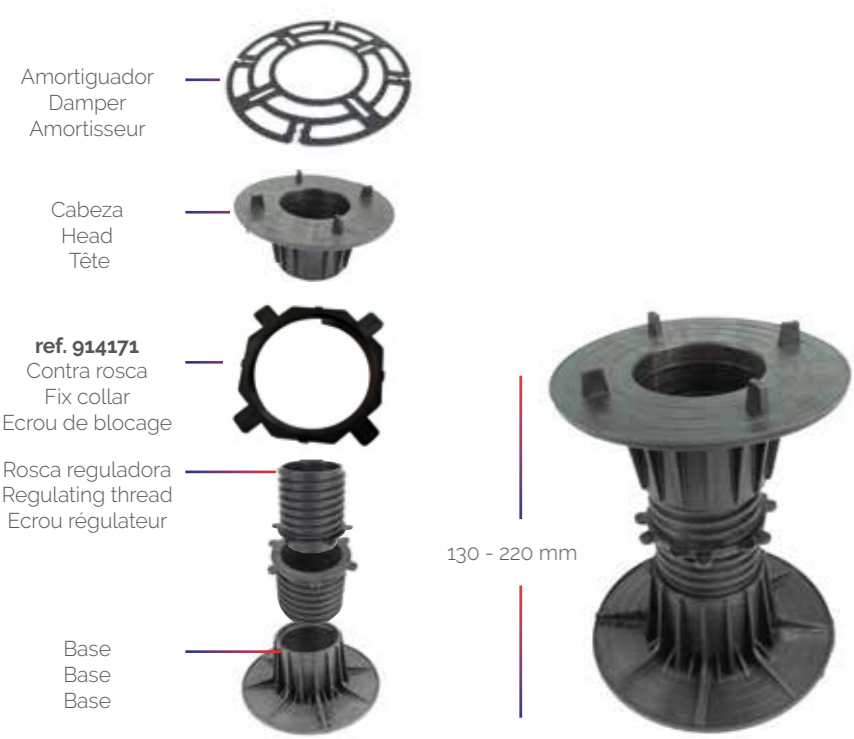

Amortiguador
Damper
Amortisseur

Cabeza
Head
Tête

ref. 914171
Contra rosca
Fix collar
Ecrou de blocage

Rosca reguladora
Regulating thread
Ecrou régulateur

Base
Base
Base

130 - 220 mm

DESNIVEL
Unevenness
Denivelés

CÓDIGO Code / Code	914072	914089	914096
------------------------------	---------------	---------------	---------------

MEDIDAS Sizes / Mesures	400-490 mm	490-580 mm	580-670 mm
-----------------------------------	------------	------------	------------

UDS. CAJA Units pack Unités pack	30	25	25
---	----	----	----

CAJAS PALET Pack pallet Pack pallet	16	16	16
--	----	----	----

* Para desniveles de 0% o 2% consultar con fábrica. For unevenness of 0% or 2% ask your commercial agent. Pour des inégalités de 0% ou 2%, demandez à votre agent commercial.



Amortiguador
Damper
Amortisseur

Cabeza
Head
Tête

ref. 914171
Contra rosca
Fix collar
Ecrou de blocage

Rosca reguladora
Regulating thread
Ecrou régulateur

Columna
Column
Colonne

Rosca reguladora
Regulating thread
Ecrou régulateur

Base
Base
Base

400 - 490 mm
490 - 580 mm
580 - 670 mm

Cajas de herramientas y estuches
Tool boxes and organizers
Boîtes à outils et coffres

Productos de ordenación
Arrangement products
Produits de rangement

Colección hogar
Home collection
Boîtes de rangement Home

Eco Tayg
Eco Tayg
Eco Tayg

Tayg Light
Tayg Light
Tayg light

Tayg Build
Tayg Build
Tayg Build

Lista de packing
Packing list
Liste d'emballage



ACCESORIOS Y COMPLEMENTOS

Accessories and complements / Accessoires et compléments



MODELO Model / Modèle	Amortiguador Dumper Amortisseur	Amortiguador Dumper Amortisseur	Contra rosca tb 750 Fix collar tb 750 Ecrou de blocage tb 750	Contra rosca tb 1000 Fix collar tb 1000 Ecrou de blocage tb 1000	Cuña desnivel 5% Slope corrector 5% Correcteur de pente 5%
CÓDIGO Code / Code	914119	914157	914164	914171	914188
MEDIDAS Sizes / Mesures	Ø 90 mm	Ø 140 mm	50 - 70 mm	65 - 670 mm	Ø 160 mm
UDS. BOLSA Units bag Unités sac	-	-	-	2	-

* Soporta modelos desde 10 mm hasta 70 mm / Supports models from 10 mm to 70 mm / Valable pour les modèles de 10 mm à 70 mm

* Soporta modelos desde 65 mm hasta 670 mm / Supports models from 65 mm to 670 mm / Valable pour les modèles de 65 mm à 670 mm

BENEFICIOS Benefits / Bénéfices

El sistema de pavimento flotante es una de las grandes soluciones en la instalación de suelo, rápido y sin necesidad de obra, tanto para exteriores como interiores, el cual cuenta con las siguientes ventajas:
The pedestals are one of the best solutions on the installation of tiles. Quick and without building work, it's valid for outside as well as inside flooring. It counts with the following advantages.
Le système de sol flottant est une des grandes solutions en pose de sol, rapide et sans besoin de travaux. Autant pour extérieur comme à l'intérieur, avec les avantages suivants.

- Con la cámara de aire que se crea, se convierte en un perfecto aislante térmico y acústico.
Thanks to the air chamber, it's a perfect thermic and acustic insulation.
Avec la chamber a air qui se crée, le sol se converti en parfait isolent thermique et phonique.
- Instalación fácil y sin necesidad de obra, ahorrando costes y tiempo.
Easy installation, saving money and time.
Installation facile et sans besoin de travaux économie de temps et argent.
- Muy resistente a la carga de peso.
Highly resistant to weight load.
Très résistant a la charg de poids.
- Las pestañas de los plots marcan la junta de dilatación.
The tabs of the plots mark the dilatation joint.
Les onglets des plots marquent le joint de dilatation.
- Su junta permite el perfecto drenaje de agua.
The joint allows the perfect water drain.
Son joint permet leparfait drainage de l'eau.
- Su colocación sin cola permite un cómodo desmontaje y aligera el peso estructural.
The colocation without mortar allows a handy dismantling and reduces the structural weight.
Sa pose sans colle permet un démontage facile et allège le poids de la structure.
- El fácil desmontaje permite una fácil instalación de tuberías y cableado.
The easy dismantling allows the installation of pipes and cables.
Le facile démontage permet une installation facile de tubes et câbles.

Modo de uso
Mode of use
Mode d'utilisation

1 Montaje por partes de los plots. Añadir contra rosca para mayor fijación. / Set by parts the PLOT. Add the locknut for better fixing / Montage du plot par parties. Ajouter le contre écrou pour un meilleur fixaje.



3 Después de colocar la primera baldosa, uso del nivel para ajustar el plot a la altura deseada. Tener en cuenta el desnivel deseado. / After the colocation of the first tile, use the leveler to adjust the PLOT desired level. / Après placer le première carreau. Utiliser le niveau a bulle pour ajuster le plot au niveau désiré.



5 Se prosigue con la colocación de baldosas, para conseguir una correcta uniformidad del pavimento. / We continue with the placement of tiles, to achieve a correct uniformity of the pavement / Nous continuons avec la mise en place des carreaux pour atteindre une uniformité correcte de l'espace.



MODO DE COLOCACIÓN DE PLOTS Method of attachment / Mode de placement

2 Calculo y trazado del espacio.
Calculation (measurement) and trace the space.
Calcule (mesure) et tracé de l'espace.



4 Ajustar la contra rosca para fijar correctamente los plot.
The locknut ensures and fix the PLOT.
Le contre écrou fixe et assure le plot.

"Se recomienda el uso de amortiguadores que dotan al sistema de una mayor durabilidad y un mayor aislamiento tanto acústico como térmico. / Its highly recommend the use of damper to give a higher durability and a better acoustic and thermic insulation / Il est recommandé l'utilisation des amortisseurs, ce qui permet une majeure durabilité et un isolement autant thermique que acoustique.

6 Fácil y rápido desmontaje.
Easy and fast dismantling.
Facile et rapide démontage.



Cajas de herramientas y estuches
Tool boxes and organizers
Boîtes a outils et coffrets

Productos de ordenación
Arrangement products
Produits de rangement

Colección hogar
Home collection
Boîtes de rangement Home

Eco Tayg
Eco Tayg
Eco Tayg

Tayg Light
Tayg Light
Tayg light

Tayg Build
Tayg Build
Tayg Build

Lista de packing
Packing list
Liste d'emballage



FACHADA, PAVÉS Y ACCESORIOS DE SEGURIDAD

Safety brackets | Safety accessories
Glass block spacer | Accessoires de sécurité

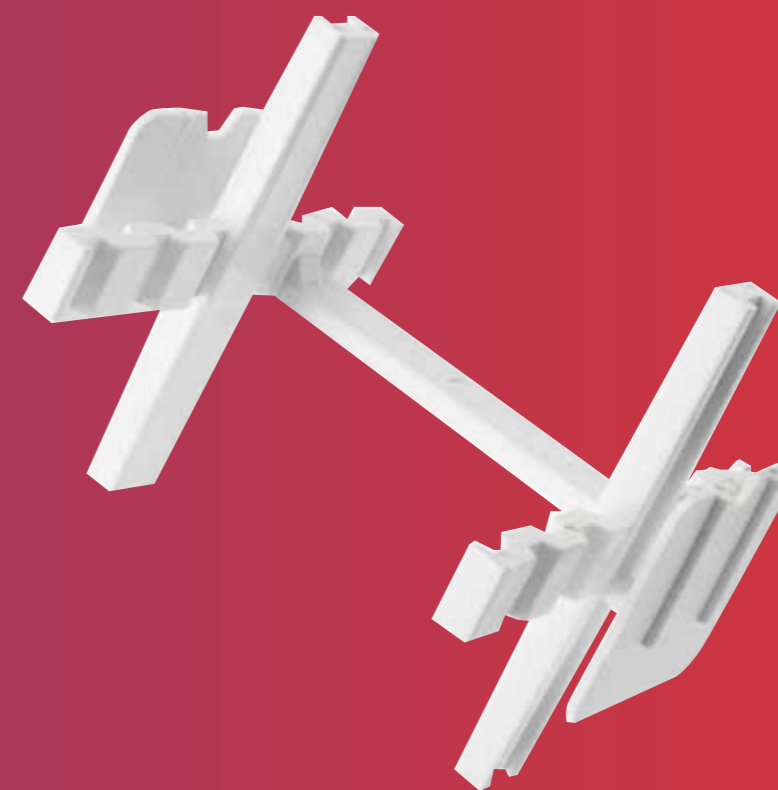



FACHADA Y PAVÉS

Safety brackets / Glass block spacer

GRAPAS DE SEGURIDAD FACHADA

Safety bracket / Agrafe façades collées

MODELO Model / Modèle	12 mm Grapa seguridad central Safety initial bracket Agrafe du bord	18 mm Grapa seguridad central Safety initial bracket Agrafe du bord
CÓDIGO Code / Code	915031	915048
MEDIDAS Sizes / Mesures	12 mm	18 mm
CONTIENE Contained / Contient	200 tacos 5 x 25 mm 200 tornillos 3,5 x 40 mm 200 block 5 x 25 mm 200 screw 3,5 x 40 mm 200 taco 5 x 25 mm 200 vis 3,5 x 40 mm	200 tacos 5 x 25 mm 200 tornillos 3,5 x 40 mm 200 block 5 x 25 mm 200 screw 3,5 x 40 mm 200 taco 5 x 25 mm 200 vis 3,5 x 40 mm
UDS. CAJA Units pack / Unités pack	200	200
ESPESOR MÁX. FIJACIÓN Maximum Fixing thickness / Epaisseur maximale de fixation	Vista / View / A vue : 10 mm Oculto / Hidden / Cachée : 20 mm	Vista / View / A vue : 16 mm Oculto / Hidden / Cachée : 32 mm
MATERIAL Material / Matériau	Acero inoxidable AISI-304 Stainless steel AISI-304 Acier inoxidable AISI-304	Acero inoxidable AISI-304 Stainless steel AISI-304 Acier inoxidable AISI-304

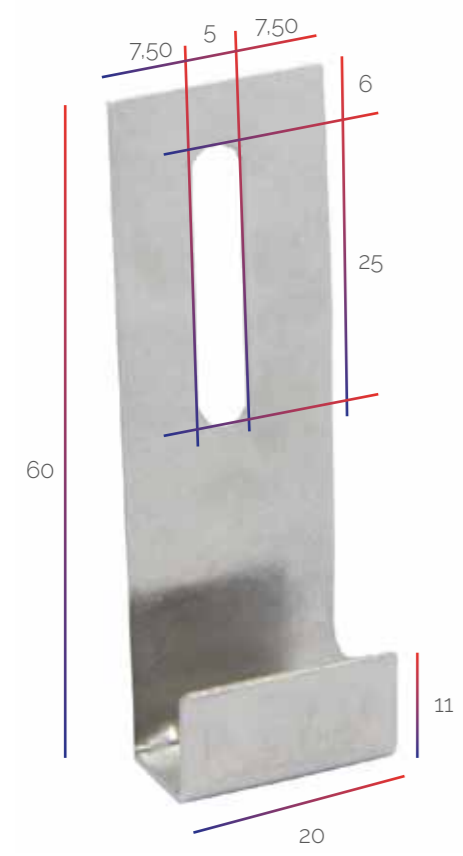
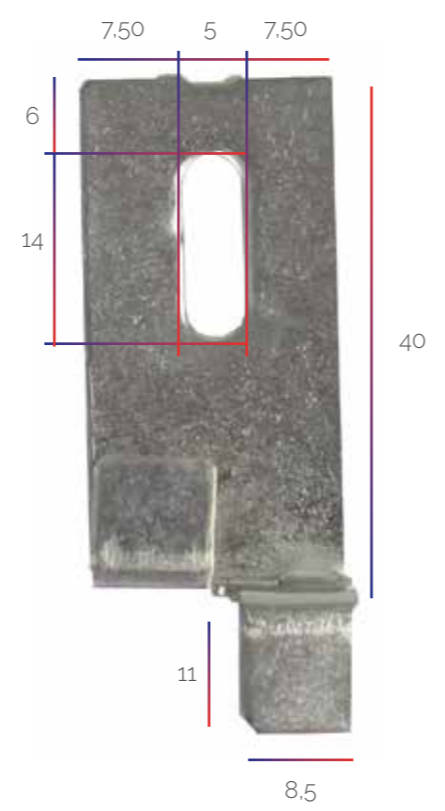

MODELO Model / Modèle	12 mm Grapa seguridad arranque final Safety intermediate bracket Agrafe intermédiaire	18 mm Grapa seguridad arranque final Safety intermediate bracket Agrafe intermédiaire
CÓDIGO Code / Code	915055	915062
MEDIDAS Sizes / Mesures	12 mm	18 mm
CONTIENE Contained / Contient	200 tacos 5 x 25 mm 200 tornillos 3,5 x 40 mm 200 block 5 x 25 mm 200 screw 3,5 x 40 mm 200 taco 5 x 25 mm 200 vis 3,5 x 40 mm	200 tacos 5 x 25 mm 200 tornillos 3,5 x 40 mm 200 block 5 x 25 mm 200 screw 3,5 x 40 mm 200 taco 5 x 25 mm 200 vis 3,5 x 40 mm
UDS. CAJA Units pack / Unités pack	200	200
ESPESOR MÁX. FIJACIÓN Maximum Fixing thickness / Epaisseur maximale de fixation	Vista / View / A vue : 10 mm Oculto / Hidden / Cachée : 20 mm	Vista / View / A vue : 16 mm Oculto / Hidden / Cachée : 32 mm
MATERIAL Material / Matériau	Acero inoxidable AISI-304 Stainless steel AISI-304 Acier inoxidable AISI-304	Acero inoxidable AISI-304 Stainless steel AISI-304 Acier inoxidable AISI-304



Descripción: Los separadores en forma de cruz son los elementos responsables de garantizar la correcta separación de los bloques pavés, con un coste bajo y rapidez de colocación.
Description: The glass-block tile spacers on the cross shape are the elements responsible for guarantee the correct separation of the glass-block with a low cost and speed of placement.
Description: Les séparateurs en forme de croix sont les éléments responsables de garantir la correcte séparation des blocs en verre, avec un bas cout et une rapidité de pose.

DISTANCIADOR BLOQUE DE VIDRIO Glass-block tile spacers / Distanciateur bloque de verre

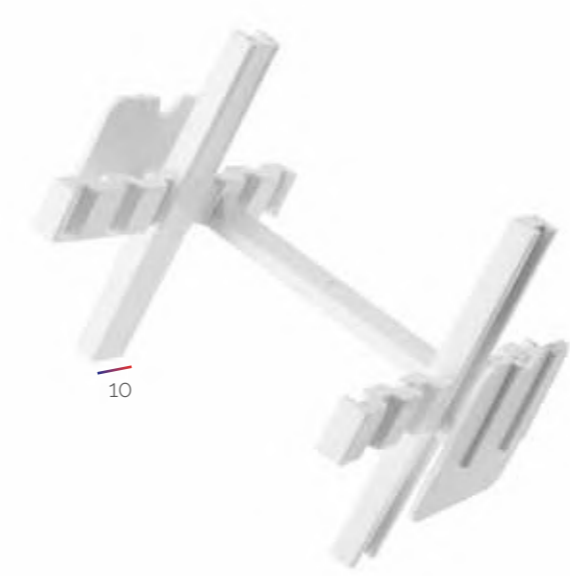

CÓDIGO Code / Code	915000	915017	915024
MEDIDAS Sizes / Mesures	10 mm	10 mm	10 mm
UDS. BOLSA Units bag Unités sac	-	-	30
UDS. CAJA Units pack Unités pack	120	300	600
CAJAS PALET Pack pallet Pack pallet	55	30	16

* Para bloques standard 19 x 19 x 8 mm
For standard blocks 19 x 19 x 8 mm
Pour des blocs standard 19 x 19 x 8 mm

Cajas de herramientas y estuches
Tool boxes and organizers
Boîtes à outils et coffrets

Productos de ordenación
Arrangement products
Produits de rangement

Colección hogar
Home collection
Boîtes de rangement Home

Eco Tayg
Eco Tayg
Eco Tayg

Tayg Light
Tayg Light
Tayg light

Tayg Build
Tayg Build
Tayg Build

Lista de packing
Packing list
Liste d'emballage



ACCESORIOS DE SEGURIDAD

Safety accessories / Accessoires de sécurité



Pantalla Protectora Facial Infantil
Child Protective Face Shield
Ecran de Protection Enfant



Pantalla Protectora Facial Adulto
Protective Face Shield
Ecran de Protection

MODELO
Model / Modèle

CÓDIGO Code / Code	918094	918087
MEDIDAS Sizes / Mesures	160 x 160 x 170 mm	160 x 160 x 210 mm
UDS. BOLSA Units bag / Unités sac	2	2
UDS. CAJA Units pack / Unités pack	70	100
CAJAS PALET Pack pallet / Pack pallet	18	18



Seta protectora (Varilla de 24 a 40 mm)
Safety cap (rod from 24 to 40 mm)
Champignon protecteur (barre de 24 a 40 mm)

Pantalla Protectora Facial Infantil
Child Protective Face Shield
Ecran de Protection Enfant



Seta protectora "P"
(Varilla de 8 a 20 mm)
Safety cap "P" (rod from 8 a 20 mm)
Champignon protecteur "P"
(barre de 8 a 20 mm)



Seta protectora (Varilla de 8 a 20 mm)
Safety cap (rod from 8 a 20 mm)
Champignon protecteur
(barre de 8 a 20 mm)



Seta protectora (Varilla de 24 a 40 mm)
Safety cap (rod from 24 to 40 mm)
Champignon protecteur
(barre de 24 a 40 mm)

MODELO
Model / Modèle

CÓDIGO Code / Code	918001	918018	918025
UDS. BOLSA Units Bag / Unités sac	250	250	150
UDS. PALET Units pallet / Unités pallet	19,500	15,000	5,400



Base guardacuerpos conix
Conix base
Base conix



MODELO
Model / Modèle

CÓDIGO Code / Code	918070	918063
MEDIDAS Sizes / Mesures	60 x 40 mm	80 x 85 mm
UDS. BOLSA Units Bag / Unités sac	50	64
UDS. PALET Units pallet / Unités pallet	2,500	1,280



MODELO
Model / Modèle

CÓDIGO Code / Code	918032	918049	918056
MEDIDAS Sizes / Mesures	40 mm	40 mm	35 x 35 mm
UDS. BOLSA Units Bag / Unités sac	150	150	150
UDS. PALET Units pallet / Unités pallet	3,600	3,150	3,150

Con tapa incorporada
Bouchon incorporé
Incorporated cover



Cod. 918049

Base cajetín línea de vida
Base life line
Base boîte de ligne de vie

Base horcax (valla de seguridad)
Base horca (safety fence)
Base horcax (cloture de securite)



Base guardacuerpos "conix"
Conix base
Base garde-corps conix

Base guardacuerpos "conix"
Conix base
Base garde-corps conix



Base guardacuerpos cuadrado
Guardrail base
Base garde-corps carrée

Cajas de herramientas y estuches
Tool boxes and organizers
Boîtes à outils et coffrets

Productos de ordenación
Arrangement products
Produits de rangement

Colección hogar
Home collection
Boîtes de rangement Home

Eco Tayg
Eco Tayg
Eco Tayg

Tayg Light
Tayg Light
Tayg light

Tayg Build
Tayg Build
Tayg Build

Lista de packing
Packing list
Liste d'emballage



ACCESORIOS PARA ENCOFRADO

Formwork accessories
Accessoires pour coffrage

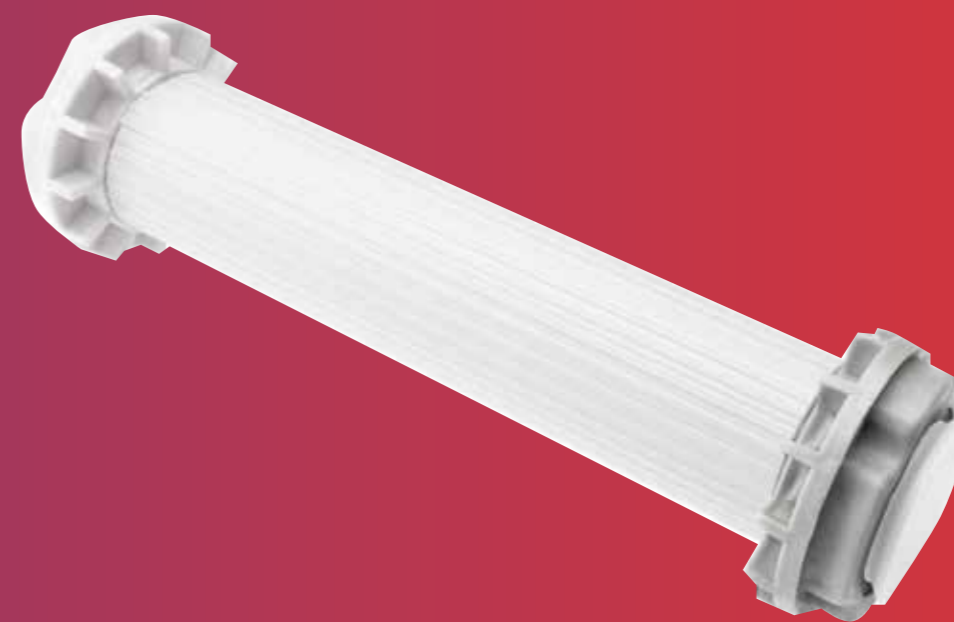



ACCESORIOS PARA ENCOFRADO

Formwork accessories / Accessoires pour coffrage

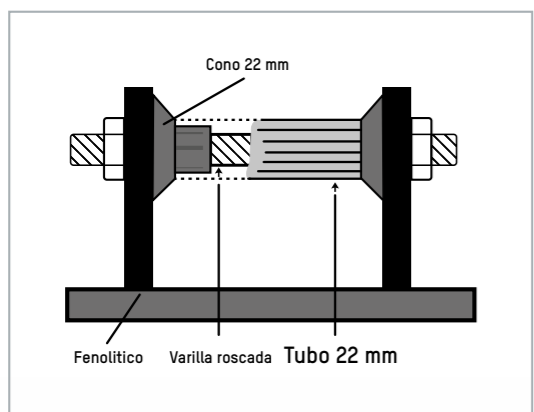

Cono tubos pasamuro Ø 22
Bushing cone cône Ø 22
Tubes de passage Ø 22

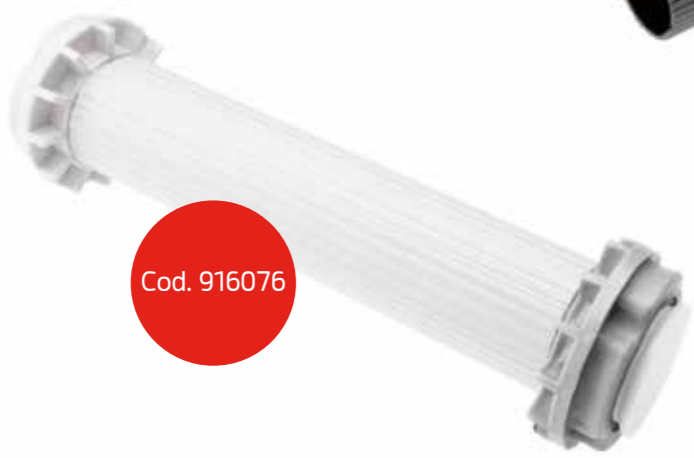

MODELO
Model / Modèle

Tubo encofrado - pasamuro Ø 22
Formwork tube Ø 22
Tuyau de passage de coffrage Ø 22

Tubo encofrado - pasamuro Ø 26
Formwork tube Ø 26
Tuyau de passage de coffrage Ø 26

Cono tubos pasamuro Ø 22
Bushing cone cône Ø 22
Tubes de passage Ø 22

Cono tubos pasamuro Ø 26
Bushing cone cône Ø 26
Tubes de passage Ø 26

Cono estanco y muro visto Ø 22
Cone waterproof raw wall Ø 22
Cône etanche et mur apparent Ø 22

CÓDIGO Code / Code	916007	916014	916090	916106	916076
MEDIDAS Sizes / Mesures	Ø 22-26 x 2 mts	Ø 26-30 x 2 mts	22 mm	26 mm	22 mm
UDS. ATADO Units / Unités	25	20	-	-	-
PAQUETES PALET Pallet packages Paquets de palette	60	60	52.000	30.000	51.000
UDS. BOLSA Units bag Unités sac	-	-	500	500	500
BOLSAS PALET Bags pallet Sacs pallet	-	-	104	60	102

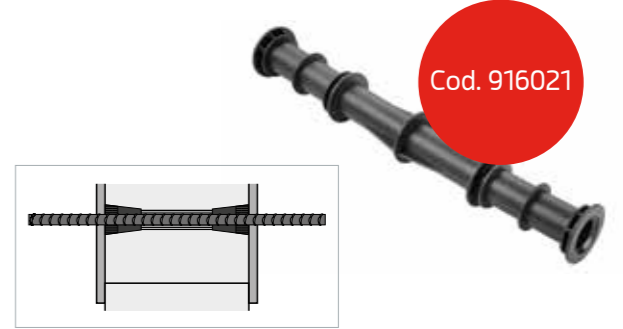

MODELO
Model / Modèle

Ø 16
Tapón estriado para encofrado
Striated plug for formwork
Bouchon estrié pour coffrage

Ø 18
Tapón liso para encofrado
Flat plug for formwork
Bouchon lisse pour coffrage

Ø 22
Tapón liso para encofrado
Flat plug for formwork
Bouchon lisse pour coffrage

Ø 24
Tapón liso para encofrado
Flat plug for formwork
Bouchon lisse pour coffrage

Ø 26
Tapón liso para encofrado
Flat plug for formwork
Bouchon lisse pour coffrage

CÓDIGO Code / Code	916113	916120	916205	916144	916151
MEDIDAS Sizes / Mesures	16 mm*	18 mm	22 mm	24 mm	26 mm
UDS. BOLSA Units bag / Unités sac	1.000	1.000	500	500	500
UDS. CAJA Units pack / Unités pack	30.000	18.000	3.500	4.500	4.500
UDS. PALET Units pallet Unités pallet	300.000	360.000	105.000	90.000	90.000

MODELO
Model / Modèle

Tapón estriado estanco y muro visto Ø 22
Plug. waterproof raw wall Ø 22
Bouchon strie etanche et mur apparent Ø 22

Tubo rápido encofrado - pasamuro Ø 22
Fast formwork tube Ø 22
Tuyau de passage rapide de coffrage Ø 22

Tubo rápido encofrado - pasamuro Ø 22
Fast formwork tube Ø 22
Tuyau de passage rapide de coffrage Ø 22

Tubo rápido encofrado - pasamuro Ø 22
Fast formwork tube Ø 22
Tuyau de passage rapide de coffrage Ø 22

CÓDIGO Code / Code	916083	916021	916038	916045
MEDIDAS Sizes / Mesures	22 mm	200 mm	250 mm	300 mm
UDS. BOLSA Units bag / Unités sac	500	-	-	-
UDS. CAJA Units pack Unités pack	4.000	200	150	100
UDS. PALET Units pallet Unités pallet	168.000	5.600	4.200	3.000

Cajas de herramientas y estuches
Tool boxes and organizers
Boîtes à outils et coffrets

Productos de ordenación
Arrangement products
Produits de rangement

Colección hogar
Home collection
Boîtes de rangement Home

Eco Tayg
Eco Tayg
Eco Tayg

Tayg Light
Tayg Light
Tayg light

Tayg Build
Tayg Build
Tayg Build

Lista de packing
Packing list
Liste d'emballage



BERENJENO Y JUNTA DILATACIÓN

Chamfer strip and dilatation joint / Liteau triangulaire et joint de dilatation

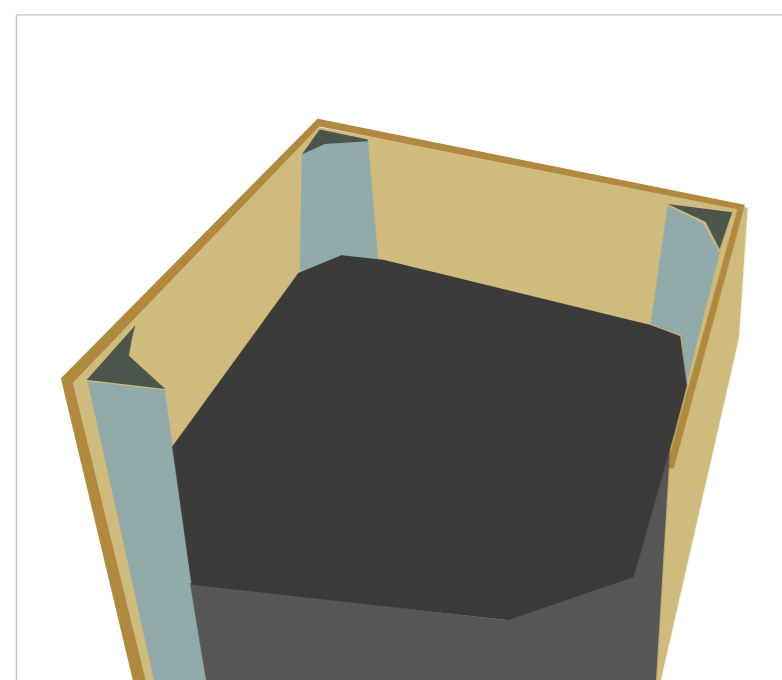

Berenjeno
Chamfer
Liteau triangulaire

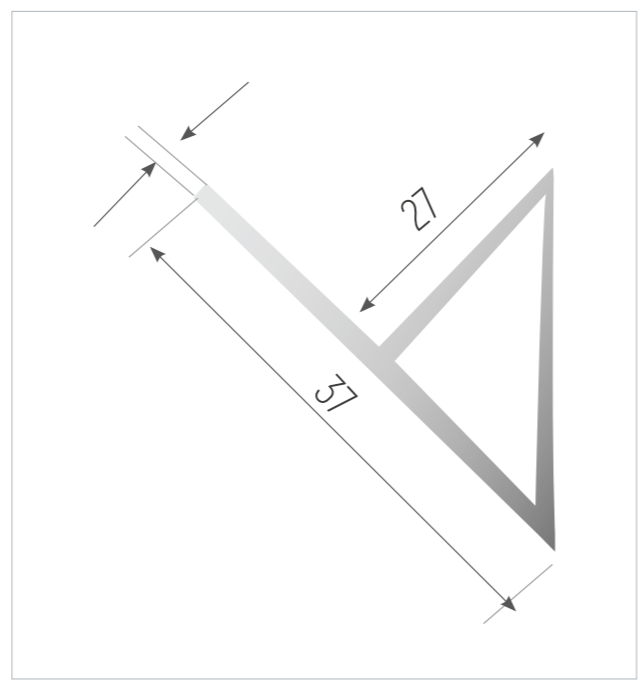

Berenjeno alas
Large chamfer strip
Liteau triangulaire avec aile

* Para otros colores y medidas consultar a fábrica.
Check with the company for another sizes and colours.
Pour d'autres couleurs et tailles, consulter l'usine.

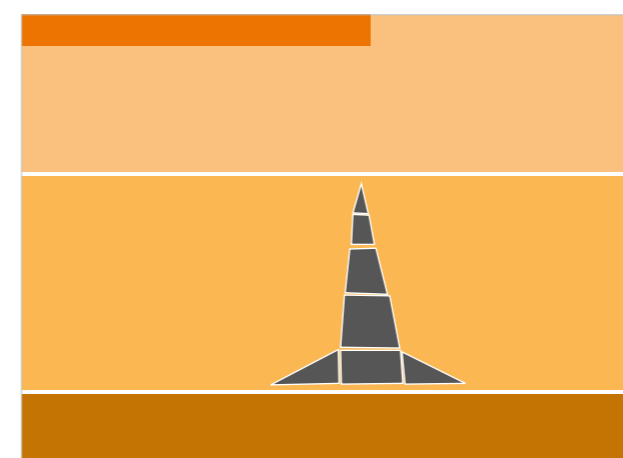

Junta de dilatación / Dilatation joint / Joint de dilatation



Junta de dilatación
Dilatation joint
Joint de dilatation



MODELO Model / Modèle	Berenjeno PVC 15 mm Chamfer strip Liteau triangulaire	Berenjeno ala PVC 20 mm Large chamfer strip PVC 20 mm Liteau triangulaire avec aile PVC 20 mm	Berenjeno PVC 20 mm Chamfer strip Liteau triangulaire	Berenjeno PVC 25 mm Chamfer strip Liteau triangulaire	Berenjeno PVC 30 mm Chamfer strip Liteau triangulaire
--------------------------	---	---	---	---	---

CÓDIGO Code / Code	916212	916199	916168	916175	916182
MEDIDAS Sizes / Mesures	15 mm x 2,50 mts	20 mm x 2,50 mts	20 mm x 2,50 mts	25 mm x 2,50 mts	30 mm x 2,50 mts
UDS. CAJA Units pack Unités pack	100	50	50	50	50
CAJAS PALET Pack pallet Pack pallet	20	20	20	20	20

MODELO Model / Modèle	Junta de dilatación 40 mm Dilatation joint 40 mm Joint de dilatation 40 mm	Junta de dilatación 80 mm Dilatation joint 80 mm Joint de dilatation 80 mm
--------------------------	--	--

CÓDIGO Code / Code	916229	916236
MEDIDAS Sizes / Mesures	40 mm x 2,50 mts	80 mm x 2,50 mts
UDS. CAJA Units pack Unités pack	30	20
CAJAS PALET Pack pallet Pack pallet	30	15

Cajas de herramientas y estuches
Tool boxes and organizers
Boîtes à outils et coffrets

Productos de ordenación
Arrangement products
Produits de rangement

Colección hogar
Home collection
Boîtes de rangement Home

Eco Tayg
Eco Tayg
Eco Tayg

Tayg Light
Tayg Light
Tayg light

Tayg Build
Tayg Build
Tayg Build

Lista de packing
Packing list
Liste d'emballage

SEPARADORES DE PARRILLA, SIERRA

Rectangular plastic spacer, saw plastic spacer, spacer / Separateur de grillage, separateur scie, séparateur

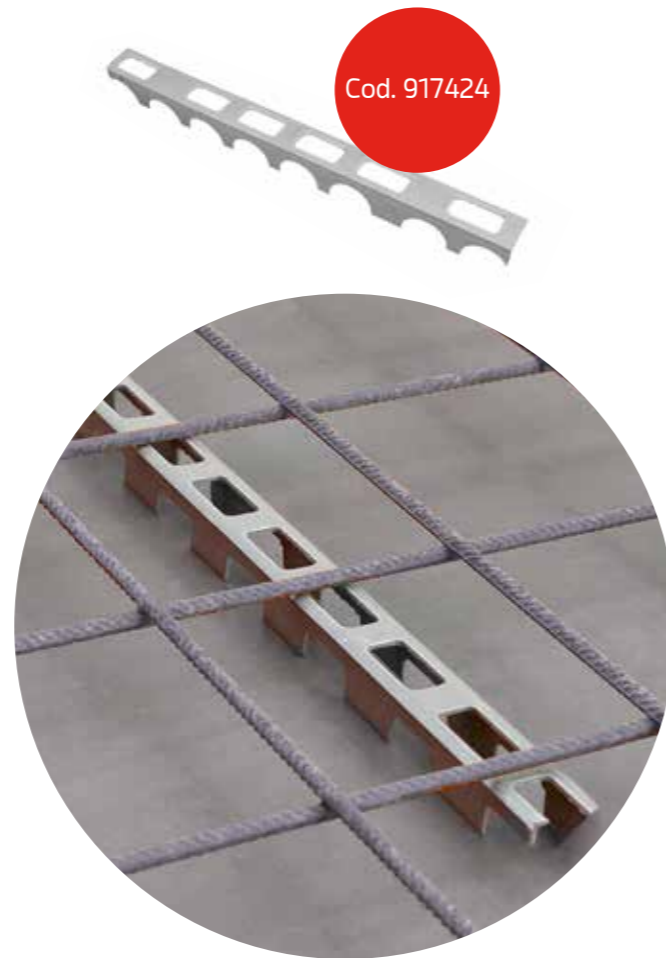

SEPARADOR SIERRA

Saw plastic spacer / Separateur scie



MODELO Model / Modèle	Separador 25 mm Spacer / Separateur	Separador 30 mm Spacer / Separateur	Separador 40 mm Spacer / Separateur	Separador 50 mm Spacer / Separateur
CÓDIGO Code / Code	917417	917424	917431	917448
MEDIDAS Sizes/ Mesures	25 mm x 2 mts	30 mm x 2 mts	40 mm x 2 mts	50 mm x 2 mts
UDS. ATADO Units tied Unités attaché	50 tiras / Strips / Bandes (100 mts)	50 tiras / Strips / Bandes (100 mts)	24 tiras / Strips / Bandes (60 mts)	30 tiras / Strips / Bandes (60 mts)
ATADO POR PALET Tied per pallet Attaché par palette	49 atados / Tied / Attaché (4900 mts)	42 atados / Tied / Attaché (4200 mts)	76 atados / Tied / Attaché (2400 mts)	28 atados / Tied / Attaché (1680 mts)

SEPARADORES PARA ENCOFRADOS

Formwork spacers / Séparateurs pour coffrage

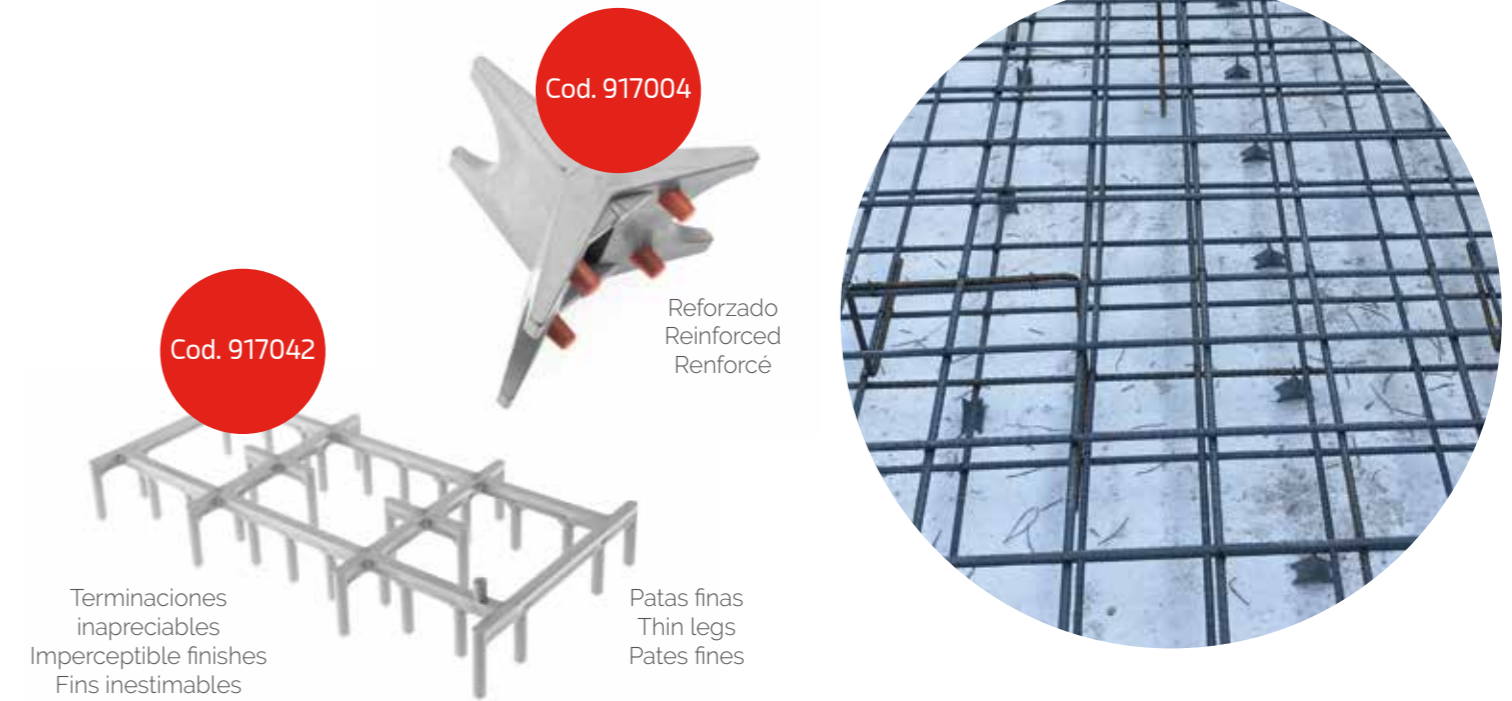

SEPARADOR DE PARRILLA 105 x 250 mm
Rectangular plastic spacer 105 x 250mm / Separateur de grillage 105 x 250mm



CÓDIGO Code / Code	917042	917059	917066	917073	917080	917097
MEDIDAS Sizes/ Mesures	20 mm	25 mm	30 mm	35 mm	40 mm	50 mm
UDS. CAJA Units pack Unités pack	268	228	200	176	152	120
CAJAS PALET Pack pallet Pack pallet	20	20	20	20	20	20

SEPARADOR CONDOR
Condor spacer / Separateur condor



CÓDIGO Code / Code	917004	917011	917028	917035
MEDIDAS Sizes/ Mesures	20 mm	30 mm	40 mm	50 mm
UDS. BOLSA Units Bag / Unités sac	1.000	500	500	500
UDS PALET Units pallet / Unités pallet	90.000	48.000	30.000	18.000



SEPARADORES PARA ENCOFRADOS

Formwork spacers / Séparateurs pour coffrage

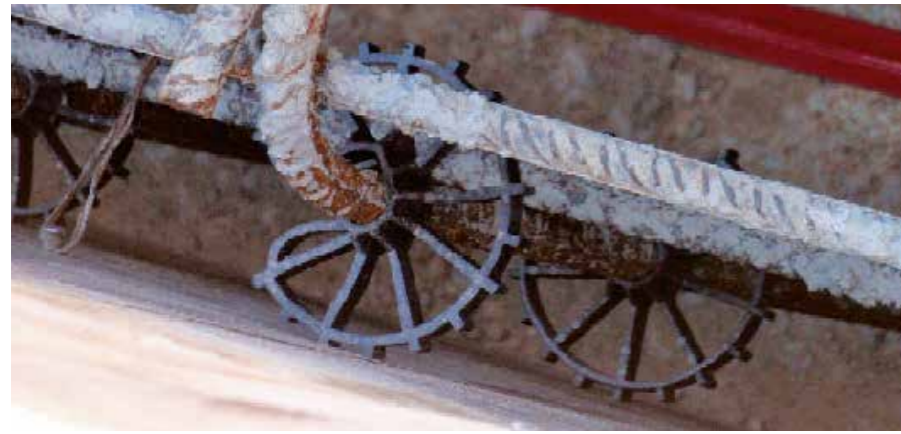

Separador timón
Rudder spacer
Séparateur gouvernail



Cod. 917172

SEPARADOR TIMÓN

Rudder spacer / Séparateur gouvernail



CÓDIGO Code / Code	917103	917110	917127	917134	917141
MEDIDAS Sizes/ Mesures	20 mm	25 mm	30 mm	35 mm	40 mm
ØVARILLA Ø Dipstick / Ø Tige	6 - 12	6 - 12	6 - 14	6 - 14	12 - 20
UDS. BOLSA Units bag / Unités sac	1.000	1.000	500	500	200
UDS. PALET Units pallet / Unités pallet	48.000	36.000	18.000	14.000	10.400

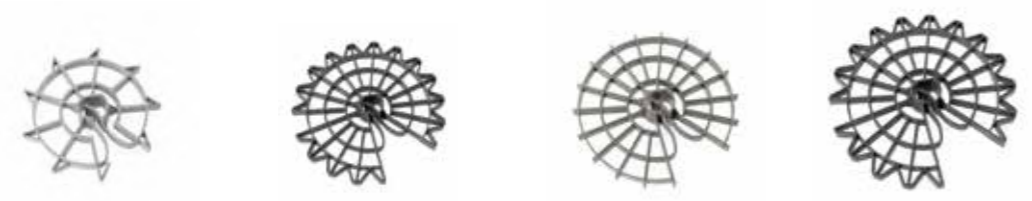

CÓDIGO Code / Code	917158	917165 REFORZADO	917172	917189 REFORZADO
MEDIDAS Sizes/ Mesures	50 mm	50 mm	60 mm	70 mm
ØVARILLA Ø Dipstick / Ø Tige	12 - 20	12 - 20	12 - 20	12 - 20
UDS. BOLSA Units bag / Unités sac	200	200	200	150
UDS. PALET Units pallet / Unités pallet	8.000	7.200	4.800	3.150

SEPARADORES DE HORMIGÓN

Concrete spacer / Séparateur de béton



Separador cubito
Concrete cube spacer
Cale béton bloc



SEPARADOR DE HORMIGÓN

Concrete spacer / Séparateur de béton

MODELO Model / Modèle	Separador cubito 20 mm Concrete cube spacer 20 mm Cale béton bloc 20 mm	Separador cubito 25 mm Concrete cube spacer 25 mm Cale béton bloc 25 mm	Separador cubito 30 mm Concrete cube spacer 30 mm Cale béton bloc 30 mm	Separador cubito 35 mm Concrete cube spacer 35 mm Cale béton bloc 35 mm
CÓDIGO Code / Code	917226	917233	917240	917257
MEDIDAS Sizes/ Mesures	20 mm	25 mm	30 mm	35 mm
UDS. BOLSA Units bag / Unités sac	700	400	300	250
BOLSAS PALET Bags pallet / Sacs pallet	50	50	50	40

* Pedidos por referencia palet completo. Reference per order full pallet / Commandes par référence palette complète.

MODELO Model / Modèle	Separador cubito 40 mm Concrete cube spacer 40 mm Cale béton bloc 40 mm	Separador cubito 50 mm Concrete cube spacer 50 mm Cale béton bloc 50 mm	Separador cubito 60 mm Concrete cube spacer 60 mm Cale béton bloc 60 mm	Separador cubito 70 mm Concrete cube spacer 70 mm Cale béton bloc 70 mm
CÓDIGO Code / Code	917264	917271	917288	917295
MEDIDAS Sizes/ Mesures	40 mm	50 mm	60 mm	70 mm
UDS. BOLSA Units bag / Unités sac	200	150	125	100
BOLSAS PALET Bags pallet / Sacs pallet	40	45	40	40

* Pedidos por referencia palet completo. Reference per order full pallet / Commandes par référence palette complète.



SEPARADORES DE HORMIGÓN

Concrete spacer / Séparateur de béton



Separador trivalente
Concrete trivalent spacer
Cale béton trivalente



Cod.
917318



MODELO
Model / Modèle

20 x 25 x 30 mm
Separador trivalente
Concrete trivalent
spacer
Cale béton trivalente

35 x 40 x 50 mm
Separador trivalente
Concrete trivalent
spacer
Cale béton trivalente

35 x 40 x 50 mm
Separador trivalente
con alambre
Concrete trivalent spacer
with wire
Cale béton trivalente
avec câble

45 x 55 x 60 mm
Separador trivalente
Concrete trivalent spacer
Cale béton trivalente

CÓDIGO Code / Code	917202	917196	917400	917219
MEDIDAS Sizes/ Mesures	20 x 25 x 30 mm	35 x 40 x 50 mm	35 x 40 x 50 mm	45 x 55 x 60 mm
UDS. CAJA Units pack / Unités pack	700	200	200	125
CAJAS PALET Pack pallet / Pack pallet	40	50	50	40

* Pedidos por referencia palet completo. Reference per order full pallet / Commandes par référence palette complète.

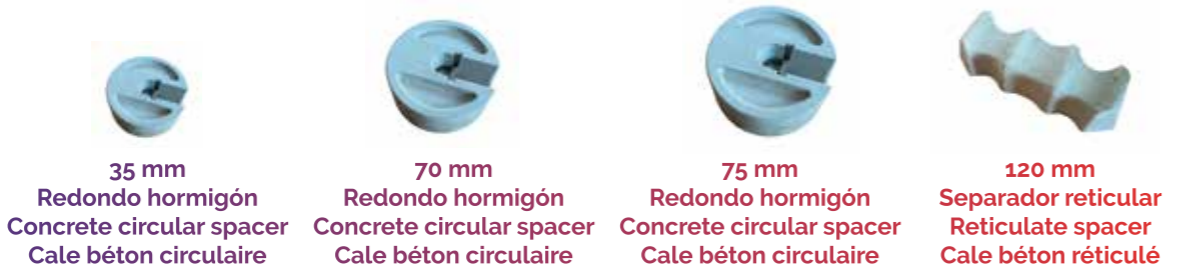

MODELO
Model / Modèle

35 mm
Redondo hormigón
Concrete circular spacer
Cale béton circulaire

70 mm
Redondo hormigón
Concrete circular spacer
Cale béton circulaire

75 mm
Redondo hormigón
Concrete circular spacer
Cale béton circulaire

120 mm
Separador reticular
Reticulate spacer
Cale béton réticulé

CÓDIGO Code / Code	917332	917318	917325	917301
MEDIDAS Sizes/ Mesures	35 mm	70 mm	75 mm	120 mm
UDS. CAJA Units pack / Unités pack	100	-	-	100
CAJAS PALET Pack pallet / Pack pallet	40	475	240	60

* Pedidos por referencia palet completo. Reference per order full pallet / Commandes par référence palette complète.



Cod.
917387



Taco con alambre
Concrete spacer with wire
Taco avec câble

MODELO
Model / Modèle

20 mm
Taco con alambre
Concrete spacer
with wire
Taco avec câble

25 mm
Taco con alambre
Concrete spacer
with wire
Taco avec câble

30 mm
Taco con alambre
Concrete spacer
with wire
Taco avec câble

40 mm
Taco con alambre
Concrete spacer
with wire
Taco avec câble

50 mm
Taco con alambre
Concrete spacer
with wire
Taco avec câble

60 mm
Taco con alambre
Concrete spacer
with wire
Taco avec câble

CÓDIGO Code / Code	917349	917356	917363	917370	917387	917394
MEDIDAS Sizes / Mesures	20 mm	25 mm	30 mm	40 mm	50 mm	60 mm
UDS. CAJA Units pack / Unités pack	500	400	300	250	200	125
CAJAS PALET Pack pallet / Pack pallet	40	50	45	40	40	40

* Pedidos por referencia palet completo. Reference per order full pallet / Commandes par référence palette complète.

Cajas de herramientas y estuches
Tool boxes and organizers
Boîtes à outils et coffrets

Productos de ordenación
Arrangement products
Produits de rangement

Colección hogar
Home collection
Boîtes de rangement Home

Eco Tayg
Eco Tayg
Eco Tayg

Tayg Light
Tayg Light
Tayg light

Tayg Build
Tayg Build
Tayg Build

Lista de packing
Packing list
Liste d'emballage



CAPAZOS

Fix collar / Seau de chantier



Cod.
919152



Cod. 919121



Cod.
919138



Capazo Obra 26
Fix collar 26
Seau de chantier 26



Capazo Obra 42
Fix collar 42
Seau de chantier 42



Capazo Obra 65
Fix collar 65
Seau de travail 65

MODELO
Model / Modèle

CÓDIGO Code / Code	919114	919152	919121
MEDIDAS Sizes / Mesures	400 x 350 x 340 mm	490 x 430 x 385mm	615 x 560 x 380 mm
MATERIAL Material / Matériau	Polietileno. Plástico reciclado no toxico Polyethylene. Non-toxic recycled plastic Polyéthylène. Plastique recyclé non toxique	Polietileno. Plástico reciclado no toxico Polyethylene. Non-toxic recycled plastic Polyéthylène. Plastique recyclé non toxique	Polietileno. Plástico reciclado no toxico Polyethylene. Non-toxic recycled plastic Polyéthylène. Plastique recyclé non toxique
CAPACIDAD Capacity / Capacité	26 L	42 L	65 L
UDS. ATADO Units tied Unités attaché	12	12	6
ATADO POR PALET Tied per pallet Attaché par palette	80	50	60

MODELO
Model / Modèle

Cubo Obra 26
Construction Flexible Tub
Bucket 26
Seau de chantier 26

21 L Cubo de mezcla
Mixing bucket
Cube de mélange

Capazo Vendimia 14
Vineyard flexible tub
bucket 14
Seau de vendange 14

Capazo Vendimia 30
Vineyard flexible tub
bucket 30
Seau de vendange 30

CÓDIGO Code / Code	919138	919015	919107	919145
MEDIDAS Sizes / Mesures	350 x 350 x 330 mm	Ø 300 x 875 mm	410 x 330 x 240 mm	470 x 430 x 280 mm
MATERIAL Material Matériau	Polietileno. Plástico reciclado no toxico Polyethylene. Non-toxic recycled plastic Polyéthylène. Plastique recyclé non toxique	-	Polietileno. Plástico reciclado no toxico Polyethylene. Non-toxic recycled plastic Polyéthylène. Plastique recyclé non toxique	Polietileno. Plástico reciclado no toxico Polyethylene. Non-toxic recycled plastic Polyéthylène. Plastique recyclé non toxique
CAPACIDAD Capacity Capacité	26 L	21 L	14 L	30 L
UDS. ATADO Units tied Unités attaché	12	8	12	12
ATADO POR PALET Tied per pallet Attaché par palette	80	-	64	48
UDS. PALET Units pallet / Unités pallet	-	160	-	-

Cajas de herramientas y estuches
Tool boxes and organizers
Boîtes à outils et coffres

Productos de ordenación
Arrangement products
Produits de rangement

Colección hogar
Home collection
Boîtes de rangement Home

Eco Tayg
Eco Tayg
Eco Tayg

Tayg Light
Tayg Light
Tayg light

Tayg Build
Tayg Build
Tayg Build

Lista de packing
Packing list
Liste d'emballage

LISTA DE PACKING

Packing list | Liste d'emballage
Verpackungsliste

Escanea código QR
Scan QR code
Scanner le code QR
QR-code scannen



08





Síguenos en:



Industrias Tayg, S.L.U.

Avda. Real de Madrid Norte, 70 - 46469 Beniparrell - Valencia (Spain)

Tlf. +34 96 121 24 62 | marketing@tayg.com | www.tayg.com



Síguenos en:



Tayg
500E
Caja de herramientas
TOOL BOX
580x295x278 mm

Industrias Tayg, S.L.U. - 46469 Beniparrell - Valencia (Spain)
Tlf. +34 96 121 24 62 | marketing@tayg.com | www.tayg.com

Industrias Tayg, S.L.U.
Avda. Real de Madrid Norte, 70 - 46469 Beniparrell - Valencia (Spain)
Tlf. +34 96 121 24 62 | marketing@tayg.com | www.tayg.com